



STEEL PILING & GEOSTRUCTURAL SYSTEMS

TABLE OF CONTENTS

SECTION		PAGE
SHEET PILES		5
	AZ HR Sheet Pile Table	6-7
	AS Flat Sheets Pile Table	8-9
	Akila® Joint Sealant System	10-11
	PZC HR Sheet Pile Table	12-13
	PS Flat Sheets Pile Table	14-18
	Cold Form Sheet Pile Table	19-20
	Steelant® – Joint Sealant	21-25
	Accessories – Shoes & Splicers	26
H-PILE TABLE		27
	H-Pile Table	28-29
	Accessories – Points & Splicers	30-31
PIPE PILES: SPIRALWELD		32-33
	Fields HDM Pipe Table	34
	Accessories – Points & Splicers	35-38
COMBINED WALL SYSTEMS		39
	Pipe AZ System	40-42
	Pipe PZC System	43-45
	ArcelorMittal HZ-M Tables	46-70
PILE CONNECTORS		71
Larssen	Corner connectors	72
	Omega corner connectors	73
	T connectors	73
	Cross connector	74
	Combined wall connectors	74
	Pipe pile, H-pile and combined wall connectors	75
Ball & Socket	MF connectors	76-77
	MF connectors for DTH driving method	78
	MF64 connectors comparative tensile test	78
	Corner connectors	79
	T connectors	80
	Cross connectors	80
Flat sheet pile connectors		81
Cold formed sheet pile connectors		81
GEOSTRUCTURALS		83
	Tie Rods	84
	Threadbar® Reinforcing Systems	85-87
	Soil Nails	88-89
	Threadbar® Anchors	90-91
	Strand Anchors	92-93
	Micropiles	94
	Threaded Bars	95
	Hollow Bar	97
STRUCTURALS		99
	Wide Flange	100-115
	MC & Channels	116-119

NOTES

A large grid of graph paper for taking notes, consisting of 20 columns and 30 rows of small squares.



SHEET PILES

AZ HOT ROLLED STEEL SHEET PILE SERIES

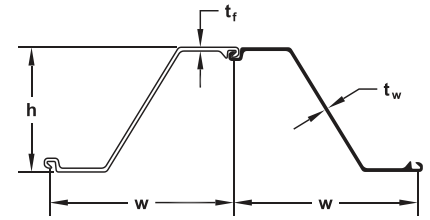

JD FIELDS <small>& COMPANY, INC.</small> <small>A FIELDS COMPANY</small>			THICKNESS		Cross Sec Area (A)	WEIGHT		SECTION MODULUS		Moment of Inertia	COATING AREA	
	Width (w)	Height (h)	Flange (t _f)	Web (t _w)		Single Pile	Wall Area	Elastic	Plastic		Both Sides	Wall Surface
	in	in	in	in	in ² /ft	lb/ft	lb/ft ²	in ³ /ft	in ³ /ft	in ⁴ /ft	ft ² /ft of single	ft ² /ft ²
SECTION	mm	mm	mm	mm	cm ² /m	kg/m	kg/m ²	cm ³ /m	cm ³ /m	cm ⁴ /m	m ² /m	m ² /m ²
AZ 12-770	30.31 770	13.52 344	0.335 8.5	0.335 8.5	5.67 120.1	48.78 72.6	19.31 94.3	23.2 1245	27.5 1480	156.9 21430	6.07 1.85	1.20 1.20
AZ 13-770	30.31 770	13.54 344	0.354 9.0	0.354 9.0	5.94 125.8	51.14 76.1	20.24 98.8	24.2 1300	28.8 1546	163.7 22360	6.07 1.85	1.20 1.20
AZ 14-770	30.31 770	13.56 345	0.375 9.5	0.375 9.5	6.21 131.5	53.42 79.5	21.14 103.2	25.2 1355	30.0 1611	170.6 23300	6.07 1.85	1.20 1.20
AZ 17-700	27.56 700	16.52 420	0.335 8.5	0.335 8.5	6.28 133.0	49.12 73.1	21.38 104.4	32.2 1730	37.7 2027	265.3 36230	6.10 1.86	1.33 1.33
AZ 18-700	27.56 700	16.54 420	0.354 9.0	0.354 9.0	6.58 139.2	51.41 76.5	22.39 109.3	33.5 1800	39.4 2116	276.8 37800	6.10 1.86	1.33 1.33
AZ 19-700	27.56 700	16.56 421	0.375 9.5	0.375 9.5	6.88 145.6	53.76 80.0	23.35 114.3	34.8 1870	41.0 2206	288.4 39380	6.10 1.86	1.33 1.33
AZ 20-700	27.56 700	16.57 421	0.394 10.0	0.394 10.0	7.18 152.0	56.11 83.5	24.43 119.3	36.2 1945	42.7 2296	300.0 40960	6.10 1.86	1.33 1.33
AZ 18-800	31.5 800	17.68 449	0.335 8.5	0.335 8.5	6.07 128.6	54.26 80.7	20.67 100.9	34.2 1840	39.7 2135	302.6 41320	6.82 2.08	1.30 1.30
AZ 20-800	31.5 800	17.72 450	0.375 9.5	0.375 9.5	6.66 141.0	59.50 88.6	22.67 110.7	37.2 2000	43.3 2330	329.9 45050	6.82 2.08	1.30 1.30
AZ 22-800	31.5 800	17.76 451	0.413 10.5	0.413 10.5	7.25 153.5	64.77 96.4	24.68 120.5	40.3 2165	47.0 2525	357.3 48790	6.82 2.08	1.30 1.30
AZ 23-800	31.50 800	18.66 474	0.453 11.5	0.354 9.0	7.12 150.6	63.56 94.6	24.22 118.2	43.3 2330	49.9 2680	404.6 55260	6.94 2.11	1.32 1.32
AZ 25-800	31.50 800	18.70 475	0.492 12.5	0.394 10.0	7.71 163.3	68.91 102.6	26.26 128.2	46.5 2500	53.8 2890	435.1 59410	6.94 2.11	1.32 1.32
AZ 27-800	31.50 800	18.74 476	0.531 13.5	0.433 11.0	8.31 176.0	74.26 110.5	28.29 138.1	49.7 2670	57.6 3100	465.5 63570	6.94 2.11	1.32 1.32
AZ 24-700	27.56 700	18.07 459	0.441 11.2	0.441 11.2	8.23 174.1	64.30 95.7	28.00 136.7	45.2 2430	53.5 2867	408.8 55820	6.33 1.93	1.38 1.38
AZ 26-700	27.56 700	18.11 460	0.480 12.2	0.480 12.2	8.84 187.2	69.12 102.9	30.10 146.9	48.4 2600	57.1 3070	437.3 59720	6.33 1.93	1.38 1.38
AZ 28-700	27.56 700	18.15 461	0.520 13.2	0.520 13.2	9.46 200.2	73.93 110.0	32.19 157.2	51.3 2760	60.9 3273	465.9 63620	6.33 1.93	1.38 1.38
AZ 28-750	29.53 750.0	20.04 509.0	0.472 12.00	0.394 10.00	8.09 171.2	67.73 100.80	27.53 134.40	52.3 2810	60.3 3245	523.9 71540	6.93 2.11	1.41 1.41
AZ 30-750	29.53 750.0	20.08 510.0	0.512 13.00	0.433 11.00	8.73 184.7	73.08 108.80	29.70 145.00	55.9 3005	64.8 3485	561.5 76670	6.93 2.11	1.41 1.41
AZ 32-750	29.53 750.0	20.12 511.0	0.551 14.00	0.472 12.00	9.37 198.3	78.44 116.70	31.88 155.60	59.5 3200	69.2 3720	599.0 81800	6.93 2.11	1.41 1.41
AZ 36-700N	27.56 700	19.65 499	0.591 15.0	0.441 11.2	10.20 215.9	79.72 118.6	34.71 169.5	66.8 3590	76.4 4110	656.2 89610	6.73 2.05	1.47 1.47
AZ 38-700N	27.56 700	19.69 500	0.630 16.0	0.480 12.2	10.87 230.0	84.94 126.4	36.98 180.6	70.6 3795	81.1 4360	694.5 94840	6.73 2.05	1.47 1.47
AZ 40-700N	27.56 700	19.72 501	0.669 17.0	0.520 13.2	11.54 244.2	90.16 134.2	39.26 191.7	74.3 3995	85.7 4605	732.9 100080	6.73 2.05	1.47 1.47
AZ 42-700N	27.56 700	19.65 499	0.709 18.0	0.551 14.0	12.22 258.7	95.51 142.1	41.59 203.1	78.2 4205	90.3 4855	768.4 104930	6.75 2.06	1.47 1.47
AZ 44-700N	27.56 700	19.69 500	0.748 19.0	0.591 15.0	12.89 272.8	100.74 149.9	43.87 214.2	81.9 4405	95.0 5105	806.6 110150	6.75 2.06	1.47 1.47
AZ 46-700N	27.56 700	19.72 501	0.787 20.0	0.630 16.0	13.56 287.0	105.97 157.7	46.14 225.3	85.7 4605	99.5 5350	844.9 115370	6.75 2.06	1.47 1.47
AZ 48-700	27.56 700.0	19.80 503.0	0.866 22.00	0.591 15.00	13.63 288.4	106.49 158.50	46.37 226.40	88.4 4755	102.1 5490	876.2 119650	6.70 2.04	1.46 1.46
AZ 50-700	27.56 700.0	19.84 504.0	0.906 23.00	0.630 16.00	14.30 302.6	111.73 166.30	48.65 237.50	92.2 4955	106.7 5735	914.6 124890	6.70 2.04	1.46 1.46
AZ 52-700	27.56 700.0	19.88 505.0	0.945 24.00	0.669 17.00	14.97 317.0	116.97 174.10	50.93 248.70	95.9 5155	111.3 5985	953.0 130140	6.70 2.04	1.46 1.46

*Indicates standard stocking sections. Please check with your local sales representative for material availability.

AZ HOT ROLLED STEEL SHEET PILE SERIES

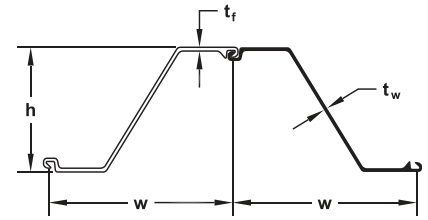

Available Steel Grades

AMERICAN			CANADIAN			EUROPEAN			AMLoCor ^{***}		
ASTM	Yield Strength		ASTM	Yield Strength		ASTM	Yield Strength		ASTM	Yield Strength	
	ksi	MPa		ksi	MPa		ksi	MPa		ksi	MPa
A328	39	270	Grade 260 W	38	260	S240 GP	35	240	Blue 320	46	320
A572 Gr . 42	42	290	Grade 300 W	43	300	S270 GP	39	270	Blue 355	51	355
A572 Gr . 50	50	345	Grade 350 W	51	355	S320 GP	46	320	Blue 390	57	390
A572 Gr . 55	55	380	Grade 400 W	58	400	S355 GP	51	355			
A572 Gr . 60	60	415				S390 GP	57	390			
A572 Gr . 65	65	450				S430 GP	62	430			
A690	50	345				S460 AP	67	460			
A690*	57	390									

Highlighted fields represent the most commonly used and readily available steel grades. *Not available for AZ 48/50/52-700. ** Corrosion resistant steel; check for availability.

Corner Piles

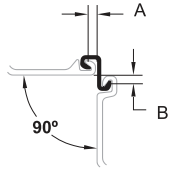

E 20
Gr: S355 GP
Wt: 9.68 lb/ft
14.4 kg/m
A: ~0.95"
24.9 mm
B: ~0.73"
18.5 mm

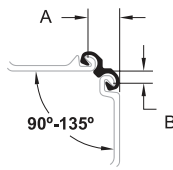

Omega 18
Gr: S355 GP / Gr. 60
Wt: 12.10 lb/ft
18.0 kg/m
A: ~2.76"
~70 mm
B: ~1.18"
~30 mm

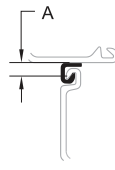

E 22
Gr: S355 GP / Gr. 60
Wt: 6.87 lb/ft
10.2 kg/m
A: ~1.28"
~32.5 mm

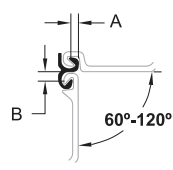

Delta 13
Gr: S355 GP / Gr. 60
Wt: 8.8 lb/ft
13.1 kg/m
A: ~0.59"
~15 mm
B: ~0.79"
~20 mm

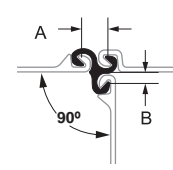

LTn
Gr: A572 Gr. 60
Wt: 14.02 lb/ft
20.9 kg/m
A: 2.075"
5.27 mm
B: 0.914"
23.2 mm

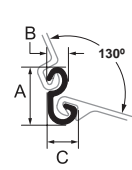

LV20n
Gr: S355 GP / Gr. 60
Wt: 8.50 lb/ft
12.6 kg/m
A: 4.09"
103.9 mm
B: 1.10"
27.9 mm
C: 2.05"
52.1 mm

Delivery Conditions & Tolerances

	ASTM A6	EN 10248
Mass	± 2.5%	± 5%
Length	+ 5 in. - 0 in.	± 200 mm
Height	± 7 mm	
Thickness	≤ 8.5 mm	± 0.5 mm
	> 8.5 mm	± 6%
Single Pile Width		± 2%
Double Pile Width		± 3%
Straightness		0.2% of the length
Ends out of Square		2% of the width

Transitional Piles

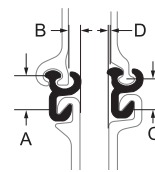

PL1Z
Gr: A572 Gr. 60
Wt: 8.95 lb/ft 13.3 kg/m
A: 1.97" 50.0 mm
B: 0.69" 17.5 mm
C: 1.61" 40.9 mm
D: 0.02" 0.5 mm

Maximum Rolled Lengths†

AZ	101.7 ft.	31.0 m
E 22	59.1 ft.	18.0 m
E 20	59.1 ft.	18.0 m
Delta 13	55.8 ft.	17.0 m
Omega 18	52.0 ft.	16.0 m

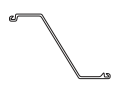

Single Pile Position A



Double Pile Form I Standard



Single Pile Position B



Double Pile Form II on Request

† Longer lengths may be possible upon request.

AS 500 STRAIGHT WEB SHEET PILES

Straight web steel sheet piles

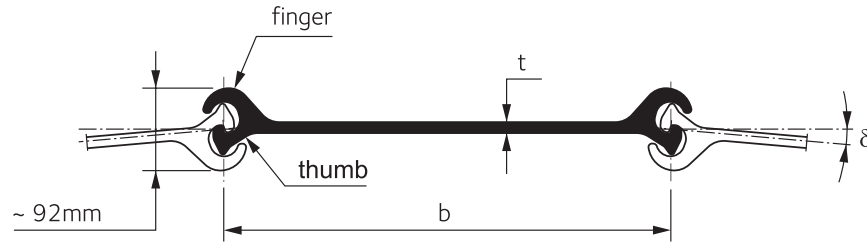



Fig. 2.1. Characteristics of AS 500 straight web sheet piles

Characteristics of AS 500® sections

 SECTION	Width ¹⁾	Web thickness	Deviation angle ²⁾	Perimeter	Steel section	Mass	Mass per m ² of wall	Moment of inertia	Section modulus	Coating area ³⁾
	b in mm	t in mm	δ °				Gw lb/ft ² kg/m ²			
	(single pile)			(single pile)			(single pile)			
				in cm	in ² cm ²	lb/ft kg/m		in ⁴ cm ⁴	in ³ cm ³	ft ² /ft m ² /m
AS 500 – 9.5	19.69 500	0.375 9.5	4.5	54.33 138	12.6 81.3	42.87 63.8	26.22 128	4.04 168	2.81 46	1.90 0.58
AS 500 – 11.0	19.69 500	0.433 11.0	4.5	54.72 139	13.9 89.4	47.17 70.2	28.67 140	4.47 186	2.99 49	1.90 0.58
AS 500 – 12.0	19.69 500	0.472 12.0	4.5	54.72 139	14.7 94.6	49.93 74.3	30.52 149	4.71 196	3.11 51	1.90 0.58
AS 500 – 12.5	19.69 500	0.492 12.5	4.5	54.72 139	15.1 97.2	51.27 76.3	31.34 153	4.83 201	3.11 51	1.90 0.58
AS 500 – 12.7	19.69 500	0.500 12.7	4.5	54.72 139	15.2 98.2	51.81 77.1	31.54 154	4.90 204	3.11 51	1.90 0.58
AS 500 – 13.0 ⁴⁾	19.69 500	0.512 13.0	4.5	55.12 140	15.6 100.6	53.09 79.0	32.36 158	5.12 213	3.30 54	1.90 0.58

Note: All straight web sections interlock with each other.

¹⁾ The calculation width, to be taken into account for design purposes and layout, is 503 mm for all AS 500 sheet piles.

²⁾ Max. deviation angle 4.0° for pile length > 20 m.

³⁾ One side, excluding inside of interlocks.

⁴⁾ Please contact JD Fields & Company for further information.

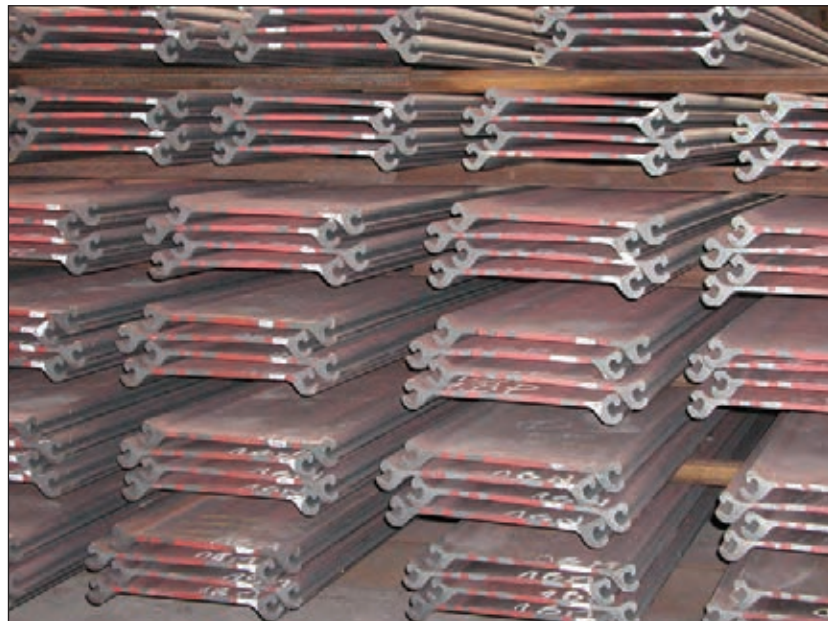

AS 500 STRAIGHT WEB SHEET PILES

Junction Piles

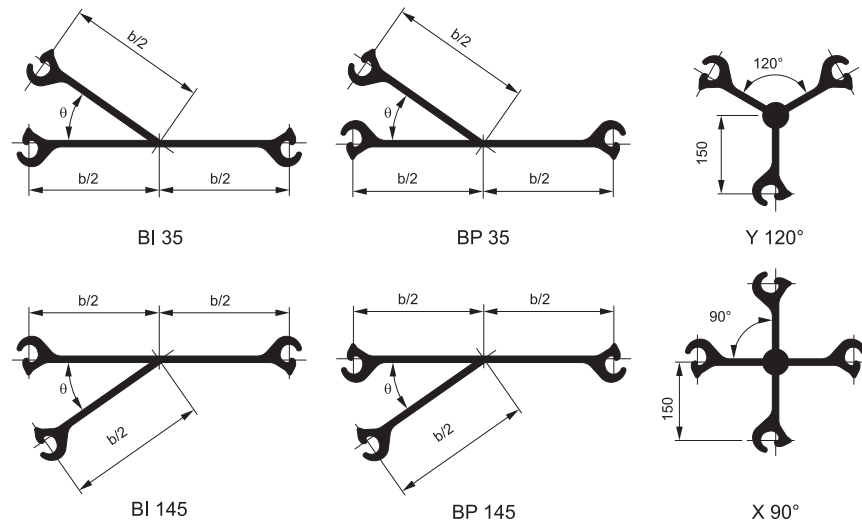

Fig. 2.2.: Characteristics of junction piles.

Connection angles θ in the range from 30° to 45° are recommended.

It is nevertheless possible to have angles up to 90°.

Bent Piles

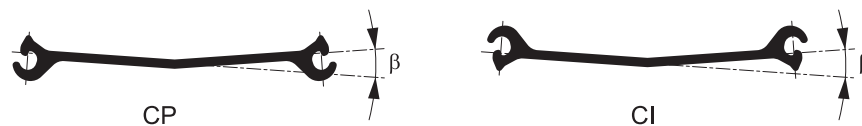

Fig. 2.3.: Bend angle β of AS 500 piles.

If deviation angles δ exceeding the values given in Table 2.1. are required, piles prebent in the mill may be used.

The maximum possible pile bend angle β is about 12°.

Delivery conditions

Interlock resistance

The following characteristic interlock resistance can be guaranteed:

SECTION	R_{ks} [kN/m] ¹⁾
AS 500 – 9.5	3 500
AS 500 – 11.0	4 000
AS 500 – 12.0	5 000
AS 500 – 12.5	5 500
AS 500 – 12.7	5 500
AS 500 – 13.0	6 000

For verification of the piles both, yielding of the web and failure of the interlock, should be checked.

The test procedure is based on Annex D of prEN10248-1 (2007).

¹⁾ For the related steel grade and further information, please contact JD Fields & Company.

AKILA® SEALING SYSTEM

PRODUCT PROPERTIES

AKILA® is a well-proven environmentally friendly high performance sealing system for ArcelorMittal sheet piles. The system is based on three compression “lips” - consisting of a product called MSP-1 - mechanically extruded into the free interlocks of single or double piles. In the case of double piles, the intermediary (paired) interlock is sealed with a second product MSP-2.

MSP-1 and MSP-2 both belong to the family of silane modified polymers (also called MS-Polymers), and are single component elastic sealants with a density of 1.41 g/cm³ and 1.48 g/cm³, respectively. They are UV-stable and have an excellent adhesion to primerless steel. Both products are resistant to humidity, weathering and temperatures between -40°C and +90°C (even up to 120°C for

short periods). They have an elongation at break of at least 380%, a Shore A hardness after complete polymerization of 58 for MSP-1 and 44 (after 14 days) for MSP-2, and are durable in contact with freshwater, seawater, as well as various hydrocarbons, bases and acids (depending on concentration, a complete list is available upon request).

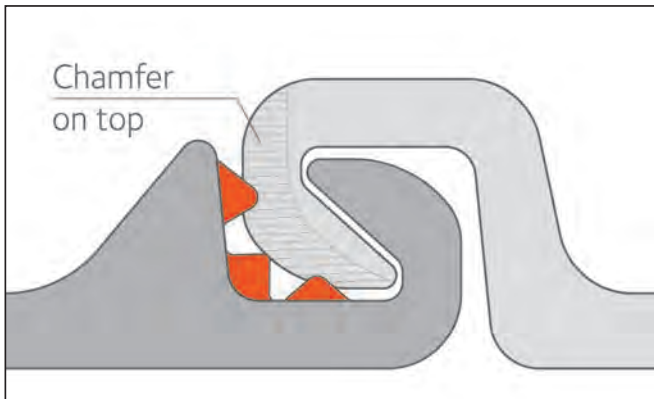

AKILA system: MSP-1 product extruded into the interlock

WATERTIGHTNESS PERFORMANCE

A series of in situ tests were carried out in stiff clays near Mittersheim (FR) and in soft sandy soil near Zeebrugge (BE), in order to determine the inverse joint resistance factor or value p_m .

Single sheet piles and crimped double sheet piles fitted out with the AKILA® system were driven into the ground using

an impact hammer as well as a vibratory hammer. After installation, watertightness was tested at water pressures of 2 and 3 bar, according to a procedure developed by Deltares and ArcelorMittal. The average inverse joint resistance values p_m were determined according to EN 12063.

Testing and results were witnessed and

certified by an independent third party (Germanischer Lloyd). The results for single and double piles are listed below.

	p_m (m/s) for water pressure of	
	2 bar	3 bar
Single Piles (MSP-1)	$4.9 \cdot 10^{-11}$	$8.6 \cdot 10^{-11}$
Single Piles (MSP-2)	$3.3 \cdot 10^{-11}$	$4.7 \cdot 10^{-11}$

AKILA® SEALING SYSTEM

ENVIRONMENTAL CERTIFICATION

MS-Polymers are considered environmentally friendly as they are solvent free and - unlike polyurethanes - do not contain isocyanates.

AKILA® is certified by the "Hygiene-Institut des Ruhrgebiets" as suitable for use in contact with groundwater.

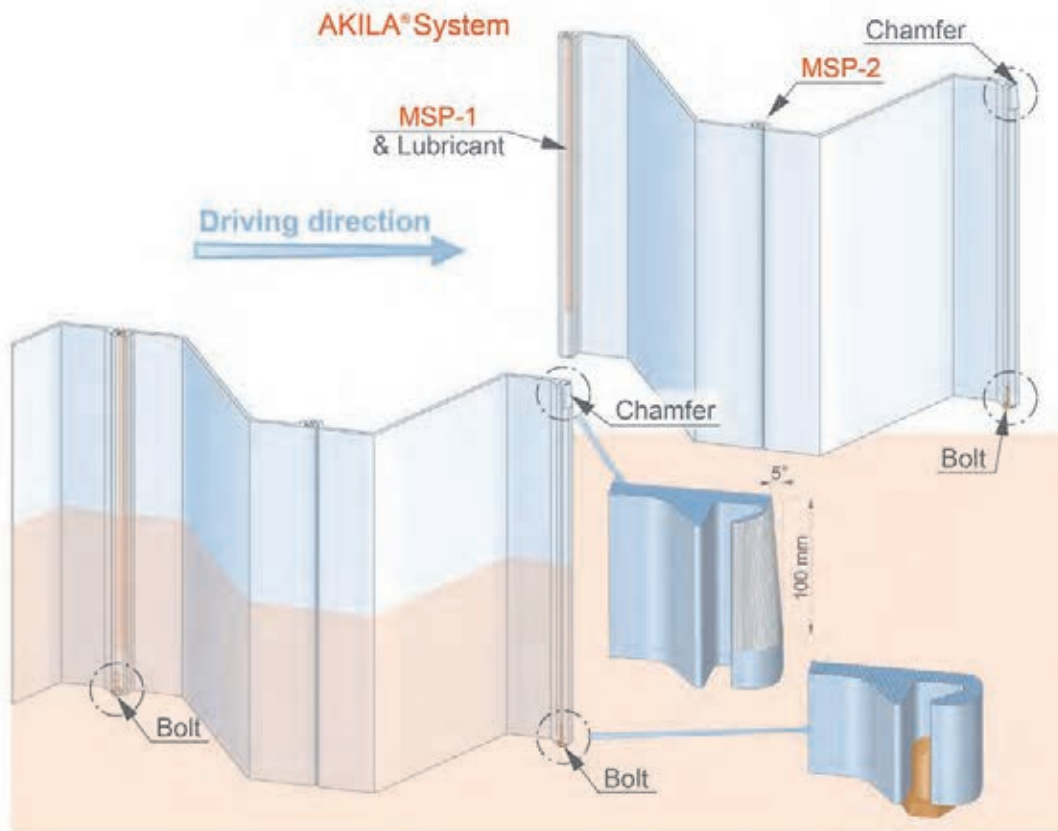

Installation recommendations (driving direction, chamfer, etc.)

DRIVING RECOMMENDATIONS

The above mentioned inverse joint resistance ρ_m values for the AKILA® system were determined through driving tests using the impact hammer and vibratory hammer. In the latter case, the driving speed must be faster than 3 m per minute. We recommend prior consultation of ArcelorMittal's technical department in

case the press-in method is used.

An environmentally friendly lubricant must be applied to the sealant in the interlocks prior to driving.

During driving, the "empty" interlock must be the leading interlock (see sketch). The leading interlocks are chamfered on the

top, and the filling of the free interlock with soil during driving can be prevented by fixing a bolt to the bottom of the interlock (or similar solution). Ambient temperature during installation must be above 0°C.

PZC HOT ROLLED SHEET PILE SERIES

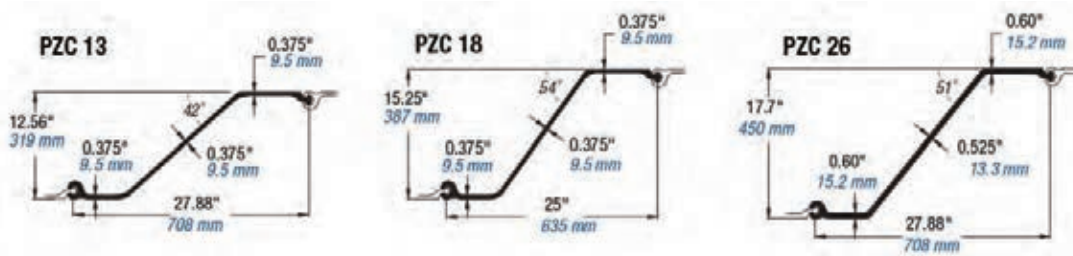

Section	Minimum Grade 60 Standard				Per Single Section							Per Unit of Wall			
	Nominal Width	Wall Depth (Height)	Web Thickness	Flange Thickness	Area	Weight	Moment of Inertia	Section Modulus	Total Surface Area	Nominal Coating Area*	Area	Weight	Moment of Inertia	Section Modulus	
	in. (mm)	in. (mm)	in. (mm)	in. (mm)	in.2 (cm2)	lbs/ft (kg/m)	in.4 (cm4)	in.3 (cm3)	ft2/ft (m2/m)	ft2/ft (m2/m)	in.2/ft (cm2/m)	lbs/ft2 (kg/m2)	in.4/ft (cm4/m)	in.3/ft (cm3/m)	
PZC 12	27.88 706	12.52 318	0.335 8.5	0.335 8.5	13.64 88.0	46.4 69.1	324.5 13,510	51.8 850	6.10 1.86	5.60 1.71	5.87 124.3	20.0 97.6	139.7 19,080	22.3 1,200	
PZC 13	27.88 708	12.56 319	0.375 9.5	0.375 9.5	14.82 95.6	50.4 75.1	353.0 14,690	56.2 920	6.10 1.86	5.60 1.71	6.38 135.1	21.7 106.0	152.0 20,760	24.2 1,300	
PZC 14	27.88 708	12.60 320	0.420 10.7	0.420 10.7	16.15 104.2	55.0 81.8	381.6 15,890	60.5 990	6.10 1.86	5.60 1.71	6.95 147.2	23.7 115.5	164.3 22,440	26.0 1,400	
PZC 17	25.00 635	15.21 386	0.335 8.5	0.335 8.5	13.64 88.0	46.4 69.1	491.8 20,470	64.6 1,060	6.10 1.86	5.60 1.71	6.55 138.6	22.3 108.8	236.1 32,235	31.0 1,670	
PZC 18	25.00 635	15.25 387	0.375 9.5	0.375 9.5	14.82 95.6	50.4 75.1	532.2 22,150	69.8 1,145	6.10 1.86	5.60 1.71	7.12 150.6	24.2 118.2	255.5 34,890	33.5 1,800	
PZC 19	25.00 635	15.30 388	0.420 10.7	0.420 10.7	16.16 104.2	55.0 81.8	576.3 23,990	75.3 1,235	6.10 1.86	5.60 1.71	7.75 164.1	26.4 128.8	276.6 37,780	36.1 1,945	
PZC 25	27.88 708	17.66 449	0.485 12.3	0.560 14.2	20.40 131.6	69.4 103.3	938.7 39,070	106.3 1,740	6.65 2.03	6.15 1.87	8.78 185.9	29.9 145.9	404.1 55,190	45.7 2,455	
PZC 26	27.88 708	17.70 450	0.525 13.3	0.600 15.2	21.72 140.1	73.9 110.0	994.3 41,390	112.4 1,840	6.65 2.03	6.15 1.87	9.35 197.9	31.8 155.4	428.1 58,460	48.4 2,600	
PZC 28	27.88 708	17.75 451	0.570 14.5	0.645 16.4	23.22 149.8	79.0 117.6	1,057 44,000	119.1 1,950	6.65 2.03	6.15 1.87	10.00 211.6	34.0 166.1	455.1 62,150	51.3 2,755	

All dimensions given are nominal. Actual flange and web thicknesses vary due to mill rolling practices; however, permitted variations for such dimensions are not addressed.

*Both sides of sheet; excludes interior of interlock.

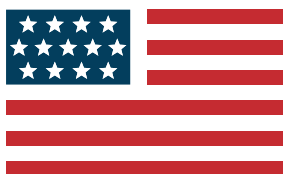

MADE IN USA

PZC HOT ROLLED SHEET PILE SERIES

SPECIFICATIONS

Gerda Steel Grades for PZC and PS Profiles

North American Grades		
ASTM	Yield Strength	
	(ksi)	(MPa)
A 328	39	270
A 572 Grade 50	50	345
A 572 Grade 60	60	415
A 572 Grade 65	65	450
A 690*	50	345

European Grades		
EN 10248	Yield Strength	
	(ksi)	(MPa)
S 240 GP	35	240
S 270 GP	39	270
S 355 GP	51	355
S 430 GP	62	430
S 450 GP	65	450

* A690 contains specified levels of Ni, Cu, and P at higher levels than the other listed grades on the table.

A572 Grade 60 and S 355 GP are the most economical and readily available grades. Please inquire for minimum order requirements for other grades.

	ASTM A328	ASTM A572-50	ASTM A572-60	ASTM A572-65	ASTM A690
C %	**	0.23 max	0.26 max	0.23 max	0.22 max
Mn %	**	1.35 maxA	1.35 maxA	1.65 maxB	0.60 - 0.90C
P %	0.035 max	0.04 max	0.04 max	0.04 max	0.08 - 0.15
S %	0.04 max	0.05 max	0.05 max	0.05 max	0.04 max
Si %	**	0.40 max	0.40 max	0.40 max	0.40 max
Cu %	**	**	**	**	0.50 min
Ni %	**	**	**	**	0.40 - 0.75
Cr %	**	**	**	**	**
Mo %	**	**	**	**	**
Sn %	**	**	**	**	**
V %	**	0.010 - 0.15*	0.010 - 0.15*	0.010 - 0.15*	**
Cb / Nb %	**	0.005 - 0.05*	0.005 - 0.05*	0.005 - 0.05*	**
Yield ksi [MPa]	39 min [270]	50 min [345]	60 min [415]	65 min [450]	50 min [345]
Tensile ksi [MPa]	65 min [450]	65 min [450]	75 min [520]	80 min [550]	70 min [485]
Elong %	17 @ 8 in.	18 @ 8 in.	16 @ 8 in.	15 @ 8 in.	18 @ 8 in.

*would contain singly or in combination, dependent on production type (1, 2 or 3)

**= not specified (Where **is shown for copper a minimum of 0.20 may be specified).

(A) For each reduction of 0.01% below C maximum, an increase of 0.06% Mn above specified maximum is permitted, up to a maximum of 1.50%.

(B) For material with thickness of 1/2" (13mm) or less, Mn maximum of 1.35% would apply when C is greater than 0.21%.

(C) For each reduction of 0.01% below C maximum, an increase of 0.06% Mn above specified maximum is permitted, up to a maximum of 1.10%.

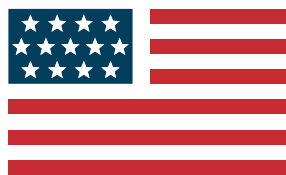

MADE IN USA

PS (FLAT SHEET) PILING

PS (FLAT SHEET) PILING PROPERTIES

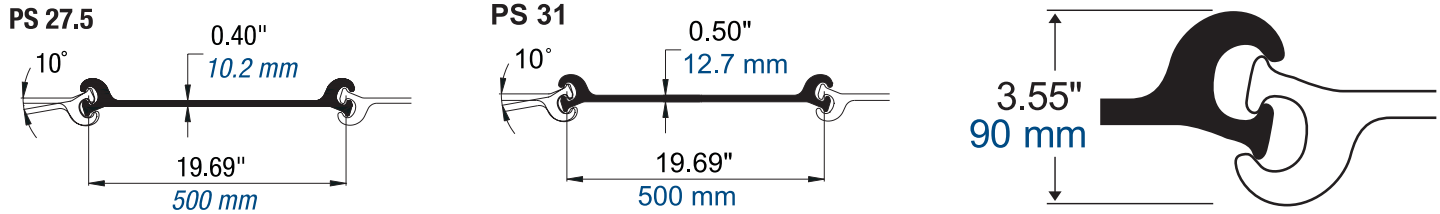

Minimum Grade 60 Standard					Per Single Section						Per Unit of Wall			
Section	Nominal Width	Depth (Height)	Wall Depth (Height)	Web Thickness	Area	Weight	Moment of Inertia	Section Modulus	Total Surface Area	Nominal Coating Area*	Area	Weight	Moment of Inertia	Section Modulus
	in. (mm)	in. (mm)	in. (mm)	in. (mm)	in.2 (cm2)	lbs/ft (kg/m)	in.4 (cm4)	in.3 (cm3)	ft2/ft (m2/m)	ft2/ft (m2/m)	in.2/ft (cm2/m)	lbs/ft2 (kg/m2)	in.4/ft (cm4/m)	in.3/ft (cm3/m)
PS 27.5	19.69	2.83	3.55	0.40	13.26	45.1	5.0	3.2	4.50	3.64	8.08	27.5	3.0	1.9
	500	72	90	10.2	85.5	67.1	207	52	1.37	1.11	171.0	134.2	414	103
PS 31	19.69	2.83	3.55	0.50	14.96	50.9	5.0	3.2	4.50	3.64	9.11	31.0	3.0	1.9
	500	72	90	12.7	96.5	75.7	207	52	1.37	1.11	192.9	151.4	414	103

*Both sides of sheet; excludes interior of interlock.

All listed dimensions are nominal. Due to rolling practices, variations in web thickness is common. Permitted variations for such dimensions are not addressed.



Grade	Minimum Interlock Strength ⁽¹⁾	Minimum Swing ⁽²⁾
A328	16 kips/in. (2,800 kN/m)	10 degrees
A572-50	20 kips/in. (3,500 kN/m)	10 degrees
A572-60	24 kips/in. (4,200 kN/m)	10 degrees

Higher interlock strengths are available; obtainable swing may be reduced in interlock strengths above 24 kips/in (4,200 kN/m).

- (1) These minimum ultimate interlock strengths assume proper interlocking of sheets. To verify the strength of PS Sheet Piling, consider both yielding of the web and failure of the interlock.
- (2) Swing reduces 1.5 degrees for each 10 feet (3 meters) in length over 70 feet (21 meters).

As a general rule, Gerdau advises against interlocking PS sections with other producers' section(s). Gerdau PS 27.5 and PS 31 can be interlocked together. PS and Z-Piling sections should not be interlocked together.

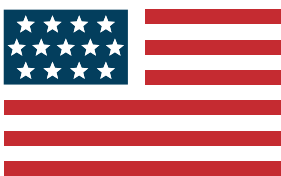

MADE IN USA

PS (FLAT SHEET) PILING

PS FLAT SHEET PILING 30° EXTRUDED WYE LAYOUT

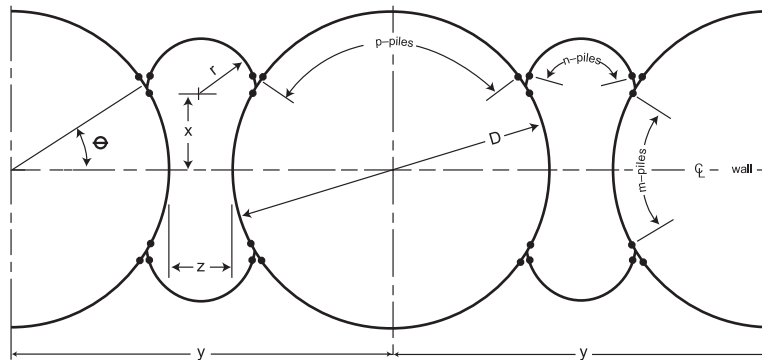

Θ is measured to the center of the 30° connection

Number of Piles in Cell†	D ft (m)	z ft (m)	y ft (m)	r ft (m)	X ft (m)	Θ deg	Number of Piles			Area		Average Width ft (m)	Layout Number (see Website)
							m	n	p	Within Circle sg ft (sw m)	Between Circles sg ft (sg m)		
78	39.07	12.88	51.96	9.1	9.88	31.8	13	17	24	1199	549	33.6	2
	11.91	3.93	15.84	2.77	3.01					111.4	51.0	10.2	
84	42.21	12.47	54.61	9.1	10.66	31.6	14	17	26	1399	566	35.9	1
	12.87	3.80	16.65	2.77	3.25					130.0	52.6	10.9	
90	45.34	14.14	59.48	10.15	11.45	31.5	15	19	30	1615	692	38.8	2
	13.82	4.31	18.13	3.09	3.49					150.0	64.3	11.8	
96	48.48	13.72	62.19	10.15	12.23	31.4	16	19	30	1846	711	41.1	1
	14.78	4.18	18.96	3.09	3.73					171.5	66.1	12.5	
102	51.61	15.39	67	3.41	13.01	30.2	17	21	32	2092	853	44	2
	15.73	4.69	20.42	0	3.97					194.4	79.2	13.4	
108	54.74	14.97	69.71	11.2	13.8	31.3	18	21	34	2354	873	46.3	1
	16.68	4.56	21.25	3.41	4.21					218.7	81.1	14.1	
114	57.88	16.64	74.51	12.24	14.58	31.2	19	23	36	2631	1029	49.1	2
	17.64	5.07	22.71	3.73	4.44					244.4	95.6	15.0	
120	61.01	16.22	77.23	12.24	15.36	31.1	20	23	38	2923	1051	51.5	1
	18.60	4.94	23.54	3.73	4.68					271.6	97.6	15.7	
126	64.14	17.89	82.03	13.28	16.15	31.1	21	25	40	3232	1222	54.3	2
	19.55	5.45	25.00	4.05	4.92					300.3	113.5	16.6	
132	67.28	19.56	86.83	14.33	16.93	31	22	27	42	3555	1406	57.1	1
	20.51	5.96	26.47	4.37	5.16					330.3	130.6	17.4	
138	70.41	19.14	89.55	14.33	17.71	31	23	27	44	3894	1432	59.5	2
	21.46	5.83	27.29	4.37	5.40					361.8	133.0	18.1	
144	73.55	20.81	94.35	15.37	18.5	31	24	29	46	4248	1631	62.3	1
	22.42	6.34	28.76	4.68	5.64					394.7	151.5	19.0	
150	76.68	20.39	97.07	15.37	19.28	30.9	25	29	48	4618	1657	64.6	2
	23.37	6.21	29.59	4.68	5.88					429.0	153.9	19.7	
156	79.81	22.06	101.87	16.42	20.06	30.9	26	31	50	5003	1871	67.5	1
	24.33	6.72	31.05	5.00	6.11					464.8	173.8	20.6	

†Includes 4 extruded 30° Wye connectors

All dimensions given are nominal.



PS (FLAT SHEET) PILING

PS FLAT SHEET PILING 90° EXTRUDED TEE LAYOUT

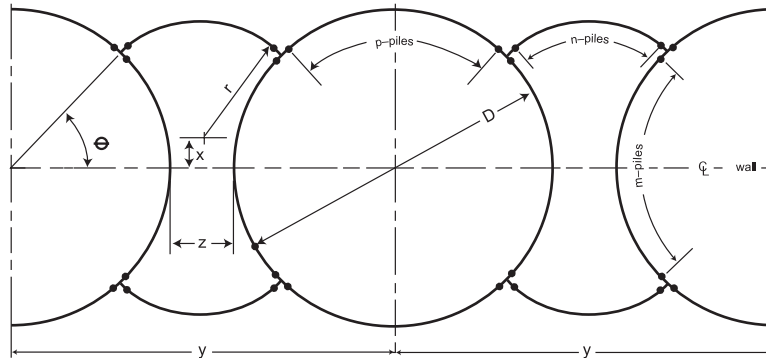

Θ is measured to the center of the 90° connection

Number of Piles in Cell†	D ft (m)	z ft (m)	y ft (m)	r ft (m)	X ft (m)	Θ deg	Number of Piles			Area		Average Width ft (m)	Layout Number (see Website)
							m	n	p	Within Circle sq ft (sq m)	Between Circles sq ft (sq m)		
44	21.20	7.53	28.73	9.72	0.68	45.3	10	9	10	353	197	19.2	4
	6.46	2.30	8.76	2.96	0.21					32.8	18.3	5.9	
48	23.29	6.84	30.13	9.67	1.45	45.2	11	9	11	426	203	20.9	6
	7.10	2.08	9.18	2.95	0.44					39.6	18.9	6.4	
52	25.38	6.31	31.69	9.73	2.15	45.2	12	9	12	506	210	22.6	4
	7.74	1.92	9.66	2.97	0.66					47.0	19.5	6.9	
56	27.47	5.62	33.09	9.68	2.92	45.2	13	9	13	593	213	24.3	6
	8.37	1.71	10.09	2.95	0.89					55.1	19.8	7.4	
60	29.56	5.09	34.64	9.73	3.62	45.2	14	9	14	686	218	26.1	4
	9.01	1.55	10.56	2.97	1.10					63.7	20.3	8.0	
64	31.65	5.95	37.60	10.76	3.58	45	15	10	15	787	264	27.9	3
	9.65	1.81	11.46	3.28	1.09					73.1	24.5	8.5	
68	33.73	5.42	9.15	10.82	4.28	45	16	10	16	894	269	29.7	5
	10.28	1.65	11.93	3.30	1.30					83.1	25.0	9.1	
72	35.82	4.73	40.55	10.76	5.05	45.2	17	10	17	1008	269	31.5	3
	10.92	1.44	12.36	3.28	1.54					93.6	25.0	9.6	
76	37.91	5.59	43.51	11.83	5.09	45.1	18	11	18	1129	324	33.4	4
	11.55	1.70	13.26	3.61	1.55					104.9	30.1	10.2	
80	40.00	4.91	44.91	11.77	5.87	45.1	19	11	19	1257	323	35.2	6
	12.19	1.50	13.69	3.59	1.79					116.8	30.0	10.7	
84	42.09	5.92	8.02	12.91	5.76	45	20	12	20	1391	386	37.0	5
	12.83	1.80	14.64	3.93	1.76					129.2	35.9	11.3	
88	44.18	5.24	49.42	12.85	6.53	45	21	12	21	1533	384	38.8	3
	13.47	1.60	15.06	3.92	1.99					142.4	35.7	11.8	
92	46.27	6.10	49.42	13.92	6.57	45.1	22	13	22	1681	450	40.7	4
	14.10	1.86	15.06	4.24	2.00					156.2	41.8	12.4	
96	48.36	5.42	3.77	13.86	7.34	45.1	23	13	23	1837	448	42.5	6
	14.74	1.65	16.39	4.22	2.24					170.7	41.6	13.0	
100	50.45	4.88	55.33	13.92	8.04	45.1	24	13	24	1999	451	44.3	4
	15.38	1.49	16.86	4.24	2.45					185.7	41.9	13.5	
104	52.54	5.74	58.28	14.94	8.01	45	25	14	25	2168	445	46.1	3
	16.01	1.75	17.76	4.55	2.44					201.4	41.3	14.1	
108	54.63	6.61	61.24	16.01	8.05	45.1	26	15	26	2344	596	48.0	4
	16.65	2.01	18.67	4.88	2.45					217.8	55.4	14.6	
112	56.72	5.92	62.64	15.95	8.82	45.1	27	15	27	2526	592	49.8	6
	17.29	1.80	19.09	4.86	2.69					234.7	55.0	15.2	
116	58.80	5.39	64.19	15.95	9.52	45.1	28	15	28	2716	595	51.6	4
	17.92	1.64	19.57	4.86	2.90					252.3	55.3	15.7	
120	60.89	6.25	67.14	17.03	9.49	45	29	16	29	2912	674	53.4	3
	18.56	1.91	20.46	5.19	2.89					270.5	62.6	16.3	
124	62.98	5.71	68.7	17.08	10.19	45	30	16	30	3116	677	55.2	5
	19.20	1.74	20.94	5.21	3.11					289.5	62.9	16.8	
128	65.07	5.03	70.1	17.03	10.96	45	31	16	31	3326	670	57.0	3
	19.83	1.53	21.37	5.19	3.34					309.0	62.2	17.4	

†Includes 4 extruded 90° Tee connectors

All dimensions given are nominal.

PS (FLAT SHEET) PILING

DIAMETERS AND AREAS OF CIRCULAR CELLS USING PS 27.5 AND PS 31

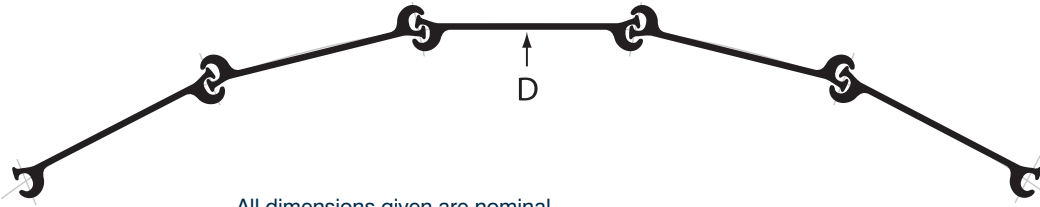

All dimensions given are nominal.

Number of Pieces	PS 27.5 & PS 31		Requires Swing degrees	Theoretical Bend degrees \ominus	Suggested Bend degrees \ominus
	D ft	Area ft ²			
12	21.20	7.53	28.73	9.72	0.68
14	7.31	42	25.7	15.7	25.0
16	8.36	55	22.5	12.5	20.0
18	9.40	69	20.0	10.0	15.0
20	10.45	86	18.0	8.0	15.0
22	11.49	104	16.4	6.4	15.0
24	12.53	123	15.0	5.0	10.0
26	13.58	145	13.8	3.6	10.0
28	14.62	168	12.9	2.9	10.0
30	15.67	193	12.0	2.0	10.0
32	16.71	219	11.3	1.3	10.0
34	17.76	248	10.6	0.6	10.0
36	18.80	278	10.0		
38	19.85	309	9.5		
40	20.89	343	9.0		
42	21.94	378	8.6		
44	22.98	415	8.2		
46	24.03	453	7.8		
48	25.07	494	7.5		
50	26.11	536	7.2		
52	27.16	579	6.9		
54	28.20	625	6.7		
56	29.25	672	6.4		
58	30.29	721	6.2		
60	31.34	771	6.0		
62	32.38	824	5.8		
64	33.43	878	5.6		
66	34.47	933	5.5		
68	35.52	999	5.3		
70	36.56	1050	5.1		
72	37.61	1111	5.0		
74	38.65	1173	4.9		
76	39.69	1238	4.7		
78	40.74	1304	4.6		
80	41.78	1371	4.5		
82	42.38	1441	4.4		
84	43.87	1512	4.3		
86	44.92	1585	4.2		
88	45.96	1659	4.1		
90	47.01	1736	4.0		
92	48.05	1813	3.9		
94	49.10	1893	3.8		
96	50.14	1975	3.8		
98	51.18	2057	3.7		
100	52.23	2143	3.6		

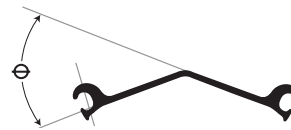

Small cells constructed with bent web piles must have half of the piles bent with the fingers inside and half with the fingers outside.

PS 27.5 and PS 31 when properly swing up to 10 degrees (in either direction) for lengths up to 70 feet (21 meters). The ability to obtain a full 10 degrees swing decreases with length because of the difficulty in handling the longer pieces. For lengths over 70 feet (21 meters), it is necessary to anticipate a reduction in obtainable swing of 1.5 degrees for each 10 feet (3 meters) increase in length.

SETTING AND DRIVING TIPS FOR PS FLAT SHEETS:

Although setting and driving techniques vary with the individual contractor and site conditions, several basic principles can generally be applied. It should be realized that the lack of good setting and driving practice can result in job delays and an unsatisfactory structure. The following suggestions are offered to help avoid problems at the site:

Handling of PS sections: These sections have very little modulus (beam strength) and are, therefore, very susceptible to handling damage. It is important that great care be taken when transporting or lifting these sections. When sheets exceed 70 feet (21 meters) in length, they should be lifted at two or more points.

Have an adequate steel template: Longer sheeting lengths will require a two or three tier template with tiers spaced 15 feet (4.5 meters) or more apart. For example, a contractor should consider at least a two-tier template when installing 70 foot (21 meters) or longer sheets as this will facilitate setting and driving and result in a superior product. As with Z-Piling, it is important that each sheet be plumbed and secured when set.

The diameter of the template is predicated on the contractor's experience and method of setting circular cells. It is important that the template diameter be less than the theoretical inside clear cell diameter to easily close the cell. Wood blocking may be utilized to adjust the template to ensure the proper setting width. Upon filling, the finished cell will expand to meet or exceed published values. When a cell with long lengths is being constructed, it may be advisable to stiffen the starter sheet by reinforcing it full length with a structural shape.

Site conditions such as swift water or hard driving may require more sheets to be reinforced.

Splicing: When it is necessary to splice PS sections, the splice point on adjacent sheets should be staggered by several feet.

Mark the driving template for each pile or pair of piles: This allows for wall adjustments to be made during the setting phase, ensuring that the sheets are located properly for cell closure.

Ensure that the sheets are properly interlocked when set: Improper interlocks become the "weak links" and result in job delays and/or failures. A closed cell must have an even number of sections (including connectors) to avoid an improper interlock. Set all sheets in the cell before driving any of the sheets, other than nominal pinning of the starter sheet(s).

"Shake out" several sheets at any closure point: Following good practice as noted above should ideally result in the last sheet sliding smoothly down into the remaining gap. Although the first sheet is set plumb and the next to last sheet is plumb, the chances that the remaining gap is uniform (19.69 inches or 500 mm) the full length is improbable. Picking up and dropping, or "shaking out," several sheets near the closure point until the sheets run smoothly will minimize the chance of driving sheets out of interlock.

Drive piles in pairs: Once sheet piles are threaded and set, it is more economical to drive two at a time. Some experts suggest that the energy needed to drive a pair may be only 50% more than that required to drive a single pile.

Drive piles in stages and work around the entire cell by alternating sheets (pairs): This allows the piles to be guided by those previously driven and lessens the chance of driving sheets out of interlock. The distance a pile, or pair of piles, should be driven at any one time will be governed by the driving conditions. In the first pass around the cell, every other pair is driven perhaps 4 feet (1.2 meters). In the second pass around the cell, the un-driven pairs are driven 8 feet (2.4 meters), 4 feet (1.2 meters) restrained by the adjacent pairs and then 4 feet (1.2 meters) into virgin soil. This procedure is continued until the cell is driven to design tip elevation. A good practice to keep the cell plumb is to reverse the direction of driving for each pass around the cell.

COLD FORM SHEET PILING

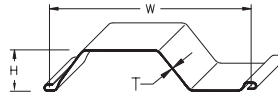

L SERIES

Section	Thickness in (mm)	Height in (mm)	Nominal Width in (mm)	Cross Sectional Area in ² (cm ²)	Pile Weight lbs/lin ft. (kg/lin m)	Wall Weight lbs/ft ² (kg/m ²)	Moment of Inertia in ⁴ /wall ft (cm ² /wall m)	Section Modulus in ³ /wall ft (cm ³ /wall m)	Coating Area Both Sides ft ² /ft m ² /m
L34	.134 (3.4)	4.10 (104)	19.7 (500)	3.58 (23.1)	12.5 (18.6)	7.62 (37.2)	5.89 (806)	2.77 (149)	4.20 (1.28)
L41	.164 (4.1)	4.12 (105)	19.7 (500)	4.39 (28.3)	15.0 (22.4)	9.17 (44.7)	7.02 (961)	3.30 (178)	4.20 (1.28)
L45	.177 (4.5)	4.13 (105)	19.7 (500)	4.47 (30.6)	16.2 (24.1)	9.90 (48.1)	7.69 (1050)	3.62 (195)	4.20 (1.28)
L50	.197 (5.0)	4.15 (104)	19.7 (500)	5.29 (34.1)	18.9 (28.2)	11.5 (56.3)	9.82 (1340)	4.14 (223)	4.20 (1.28)
L60	.236 (6.0)	4.18 (106)	19.7 (500)	6.37 (41.1)	22.3 (33.1)	13.6 (66.1)	11.8 (1610)	4.97 (268)	4.20 (1.28)
L65	.256 (6.5)	4.20 (107)	19.7 (500)	6.90 (44.5)	24.1 (35.8)	14.7 (71.6)	12.8 (1750)	5.38 (290)	4.20 (1.28)

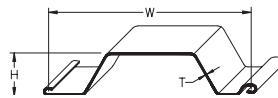

S SERIES

Section	Thickness in (mm)	Height in (mm)	Nominal Width in (mm)	Cross Sectional Area in ² (cm ²)	Pile Weight lbs/lin ft. (kg/lin m)	Wall Weight lbs/ft ² (kg/m ²)	Moment of Inertia in ⁴ /wall ft (cm ² /wall m)	Section Modulus in ³ /wall ft (cm ³ /wall m)	Coating Area Both Sides ft ² /ft m ² /m
S64	.250 (6.35)	5.91 (150)	27.75	9.97 (64.4)	33.9 (50.4)	14.7 (71.7)	24.0 (32.80)	7.89 (424)	5.90 (1.80)
S80	.313 (8.00)	5.97 (152)	27.75	12.36 (79.7)	42.1 (62.6)	18.2 (88.8)	30.0 (4100)	9.82 (528)	5.90 (1.80)

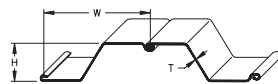

Z SERIES

Section	Thickness in (mm)	Height in (mm)	Nominal Width in (mm)	Cross Sectional Area in ² (cm ²)	Pile Weight lbs/lin ft. (kg/lin m)	Wall Weight lbs/ft ² (kg/m ²)	Moment of Inertia in ⁴ /wall ft (cm ² /wall m)	Section Modulus in ³ /wall ft (cm ³ /wall m)	Coating Area Both Sides ft ² /ft m ² /m
Z55	.217 (5.50)	8.64 (219)	24.0 (610)	7.57 (48.8)	25.8 (38.4)	12.9 (63.0)	49.7 (6790)	11.4 (613)	5.20 (1.59)
Z60	.236 (6.00)	8.66 (220)	24.0 (610)	8.26 (53.3)	28.2 (42.0)	14.1 (68.8)	54.2 (7400)	12.4 (667)	5.20 (1.59)
Z65	.256 (6.50)	8.68 (220)	24.0 (610)	8.95 (57.7)	30.6 (45.5)	15.3 (74.7)	58.7 (8010)	13.4 (720)	5.20 (1.59)
Z70	.276 (7.00)	8.70 (221)	24.0 (610)	9.64 (62.2)	33.0 (49.1)	16.5 (80.6)	63.2 (8630)	14.4 (774)	5.20 (1.59)
Z75	.295 (7.50)	8.72 (221)	24.0 (610)	10.3 (66.5)	35.2 (52.4)	17.6 (85.9)	67.7 (9250)	15.6 (839)	5.20 (1.59)

SHEET PILING SPECIFICATIONS

L SERIES

ASTM A857 minimum yield strength 36,000 psi. CSA G40.21 Gr.260W minimum yield strength 260 MPa or 37,700 psi. Hot dip galvanizing to ASTM A 123 or CSA G164.

S SERIES, Z SERIES, EZ SERIES, XZ SERIES & JZ SERIES

ASTM A328 minimum yield strength 38,500 psi. ASTM 572 Gr.50 minimum yield strength 50,000 psi. CSA G40.21 Gr.350W minimum yield strength 350 MPa or 50,800 psi. Hot dip galvanizing to ASTM A 123 or CSA G164.

COLD FORM SHEET PILING



EZ SERIES

Section	Thickness in (mm)	Height in (mm)	Nominal Width in (mm)	Cross Sectional Area in ² (cm ²)	Pile Weight lbs/lin ft. (kg/lin m)	Wall Weight lbs/ft ² (kg/m ²)	Moment of Inertia in ⁴ /wall ft (cm ² /wall m)	Section Modulus in ³ /wall ft (cm ³ /wall m)	Coating Area Both Sides ft ² /ft m ² /m
EZ75	.295 (7.50)	10.72	25.0 (635)	11.3 (73.0)	38.5 (57.4)	18.6 (90.4)	103 (14100)	19.2 (1030)	5.60 (1.71)
EZ80	.315 (8.00)	10.75	25.0 (635)	12.1 (77.9)	41.1 (61.2)	19.8 (96.4)	110 (15000)	20.5 (1100)	5.60 (1.71)
EZ88	.344 (8.75)	10.78	25.0 (635)	13.2 (85.1)	44.9 (66.8)	21.6 (105)	121 (16500)	22.4 (1200)	5.60 (1.71)
EZ95	.375 (9.50)	10.81	25.0 (635)	14.4 (92.7)	48.9 (72.8)	23.5 (115)	131 (17900)	24.4 (1310)	5.60 (1.71)

XZ SERIES

Section	Thickness in (mm)	Height in (mm)	Nominal Width in (mm)	Cross Sectional Area in ² (cm ²)	Pile Weight lbs/lin ft. (kg/lin m)	Wall Weight lbs/ft ² (kg/m ²)	Moment of Inertia in ⁴ /wall ft (cm ² /wall m)	Section Modulus in ³ /wall ft (cm ³ /wall m)	Coating Area Both Sides ft ² /ft m ² /m
XZ85	.335 (8.50)	14.06	25.0 (635)	13.6 (87.9)	46.4 (69.0)	22.3 (109)	212 (29000)	30.2 (1630)	6.03 (1.84)
XZ90	.354 (9.00)	14.09	25.0 (635)	14.4 (93.0)	48.9 (72.7)	23.5 (115)	225 (30800)	31.8 (1710)	6.03 (1.84)
XZ95	.375 (9.50)	14.12	25.0 (635)	15.2 (98.2)	51.7 (76.9)	24.8 (121)	237 (32400)	33.5 (1800)	6.03 (1.84)
XZ100	.394 (10.0)	14.15	25.0 (635)	15.9 (103.0)	54.2 (80.7)	26.0 (127)	250 (34200)	35.3 (1900)	6.03 (1.84)
XZ105	.413 (10.5)	14.17	25.0 (635)	16.7 (108.0)	56.9 (84.7)	27.3 (133)	263 (35900)	37.2 (2000)	6.03 (1.84)

DZ SERIES

Section	Thickness in (mm)	Height in (mm)	Nominal Width in (mm)	Cross Sectional Area in ² (cm ²)	Pile Weight lbs/lin ft. (kg/lin m)	Wall Weight lbs/ft ² (kg/m ²)	Moment of Inertia in ⁴ /wall ft (cm ² /wall m)	Section Modulus in ³ /wall ft (cm ³ /wall m)	Coating Area Both Sides ft ² /ft m ² /m
DZ80	.315 (8.0)	16.44 (418)	29.00 (737)	14.47 (93.3)	49.20 (73)	20.40 (99)	262.72 (35876)	31.96 (1718)	6.80 (2.08)
DZ85	.335 (9.00)	16.46 (418)	29.00 (737)	15.35 (99)	52.20 (78)	21.60 (106)	278.67 (38055)	33.86 (1820)	6.80 (2.08)
DZ90	.354 (9.50)	16.48 (419)	29.00 (737)	16.23 (104.7)	55.20 (82)	22.90 (112)	294.58 (40227)	35.75 (1922)	6.80 (2.08)
DZ95	.375 (10.0)	16.50 (419)	29.00 (737)	17.15 (110.6)	58.40 (87)	24.20 (118)	311.22 (42500)	37.72 (2028)	6.80 (2.08)
DZ100	.395 (10.5)	16.53 (420)	29.00 (737)	17.98 (116)	61.20 (91)	25.30 (124)	326.23 (44549)	39.49 (21.23)	6.80 (2.08)
DZ105	.413 (10.5)	16.54 (420)	29.00 (737)	18.85 (121.6)	64.20 (95)	26.50 (130)	341.98 (46700)	41.35 (2223)	6.80 (2.08)

JZ SERIES

Section	Thickness in (mm)	Height in (mm)	Nominal Width in (mm)	Cross Sectional Area in ² (cm ²)	Pile Weight lbs/lin ft. (kg/lin m)	Wall Weight lbs/ft ² (kg/m ²)	Moment of Inertia in ⁴ /wall ft (cm ² /wall m)	Section Modulus in ³ /wall ft (cm ³ /wall m)	Coating Area Both Sides ft ² /ft m ² /m
JZ112	.441 (11.2)	16.44	26.5 (673)	20.1 (129.7)	68.2 (101)	30.9 (151)	374 (51100)	45.3 (2430)	6.51 (1.99)
JZ120	.472 (12.0)	16.47	26.5 (673)	21.5 (138.7)	73.0 (109)	33.0 (161)	401 (54700)	48.5 (2610)	6.51 (1.99)
JZ127	.500 (12.7)	16.50	26.5 (673)	22.7 (146.5)	77.3 (115)	35.0 (171)	424 (57900)	51.4 (2760)	6.51 (1.99)

THE ULTIMATE SEALING FOR SHEET PILE WALLS

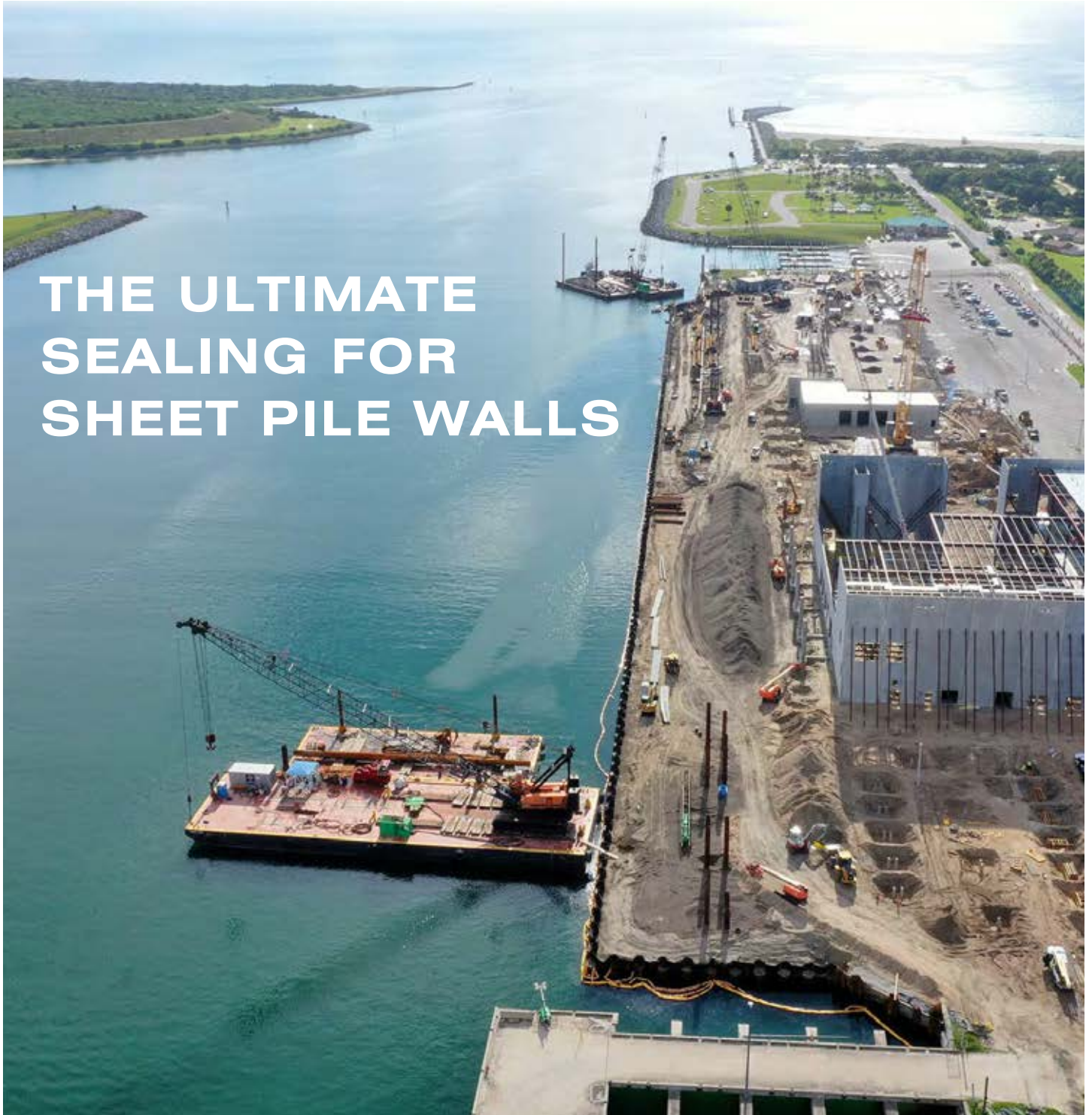



ENVIRONMENTAL CONTAINMENT

The perfect sealant - over 24 years of global experience

Steelant® is a high efficiency water sealant.

It is applied to steel sheet pile interlocks, made from sustainable natural raw materials and designed to be hot applied. When properly cured, STEELANT® provides a highly reliable water seal for sheet pile walls. It is one of the few sealing materials with a large load capacity yet still has extremely green credentials. As an interlock sealant, it has been used successfully throughout the world for more than 15 years. In this time, STEELANT® has proved to be an extremely stable material that produces outstanding results even in extreme climatic conditions such as in the tropics or the Arctic.

For all sheet pile wall constructions:

- Temporary sheet pile wall constructions
- Permanent sheet pile wall constructions
- Casting of the sheet pile wall interlock
Sheet pile wall constructions in soil containing ground water and a small fine particle fraction (gravel-type soil) and in soils with the consistency of clay
- Reduces interlock friction during driving.

Applications:

- Cofferdams in soil types with a high ground water level
- Dam renovation work
- Sealing of riverbanks
- Delimitation of underground water courses in water protection zones Sealing work on concrete and steel components

Applicable even in catch areas of drinking water collection systems

Steelant® is environmentally friendly in both production and use.

Steelant® is made under a patented formulation, designed to be highly effective and yet environmentally sound.

Official confirmation from the State Trade Supervision Department for Bavaria shows that this material is extremely "green" and even suitable for use in catch basins of drinking water systems.

Results (extract)

"The reports from the LGA come to the conclusion that the sealing compound can be used in sheet pile walls for ground and surface water without any restrictions at all. Therefore, if the product is used as intended there is no concern of harmful effects in the catchment area of drinking water collection systems."

ENVIRONMENTAL REMEDIATION

Safe and effective at water pressure levels up to 5 bar Stable and non-deforming in temperatures of up to 50°C (122°F)

STEELANT® is highly resistant to water and offers a unique and durable bond. When properly applied to the interlock chamber, STEELANT® is resistant to extreme conditions such as water pressure, ice, soil as well as movements of the sheet pile wall or displacement of the piles during transport. The material remains stable and non-deforming in the interlock even in peak daytime temperatures of 50°C (122°F).

In laboratory tests the material underwent extreme tests and was subjected to a maximum water pressure of 5 bar (5 atmospheres or 500 kPa. Roughly 130 feet of water depth). STEELANT® demonstrated no water permeability in various interlock forms during these test series.

Summary

STEELANT® can be used both for water pressure sealing requirements and large sheet pile lengths.

Flexibility with memory effect

STEELANT® contains natural rubber that gives it a unique elasticity. Thanks to this feature the sealant tolerates torsion and movements in the sheet pile wall interlock, maintains a cohesive seal, and returns to its initial position in normal or cold conditions. Conventional materials may become brittle as ambient temperatures fall to 10°C or less, which often leads to problems when work is being carried out in ground water. When installing sheet pile walls, sealant must not become brittle and remain in the interlocks to prevent leaks. STEELANT® solves this problem because it remains perfectly flexible even in low temperature ground water (which usually remains at a temperature of between 5°C to 7°C throughout the year). STEELANT® never becomes brittle and continues to create a perfect seal.

Unlike some competing material, STEELANT® does not require “activation”, it is usable as soon as the material has cooled and cured.

WATERPROOFING

Less friction

STEELANT® acts as a thin film of lubricant in the interlock chamber which reduces interlock friction during the driving process.

For any pile driving equipment

STEELANT® is suitable in equal measure for all driving methods of sheet piles (impact driving, vibration and pressing).

Innovative packaging

Simply remove the staples and place the entire sack of STEELANT® in a suitable heating chamber or application machine. The sealant will be melted completely together with its packaging. The entire package and content are used and ensures that no residual waste is created.

Ideal for precise quantity calculation, one sack of STEELANT® contains 25 kg (55 lb.) of ready-to use sealing compound. In normal operating temperatures, no additional material is required, however, in extreme temperature conditions STEELANT®-Softener can be added.

Seal and drive

After installation STEELANT® should be allowed to cool and cure. Depending on weather conditions, it is usually ready to drive in about 20-45 minutes.



Description

- Base material: Organic, natural raw materials
- Color: Olive-black
- Form: Solid
- Container: 25 kg polyethylene sacks which are melted with the material
- Melting temp: 130 to 170 °C
- Melting unit: Compound heater, ideally: Indirect thermal bath heater
- Soluble in: High concentrations of organic solvents such as xylene, benzene and biodiesel
- Density at 20 °: 0.994g (cm³)

Recommended quantity & instructions

Application quantity

Depending on the type of interlock, a quantity of about 250 g of STEELANT® will be required per meter of sheet pile wall. The quantity may be higher for used piles depending on requirements.

Additive application - STEELANT®-Softener

The addition of STEELANT®-Softener depends on the outdoor temperature at the time of the pile driving work.

- Above +5 °C: No additive required
- Down to -5 °C: 2 liters per 25 kg of STEELANT®
- Below -5 °C: 5 liters per 25 kg of STEELANT®

STEELANT®- Softener is supplied in 20-liter canisters.

IMPORTANT

Avoid overheating the casting compound at all costs since otherwise the quality of the material may be drastically reduced. The temperature must be a minimum of 130°C and a maximum of 170°C. It should be checked at regular, short intervals. During the heating phases the casting compound must be stirred at regular intervals depending on the requirement of the equipment used. Overheated casting compound must not be used.

Storage

STEELANT® can be stored for an unlimited period. Avoid direct UV radiation. Recommended temperature below 30°C.

Filling heights for interlock chambers

LARSEN

approx. 40%

HOESCH

approx. 40%

PZ/PZC

approx. 50%

COLD FORMED

approx. 50%

SHEET PILE DRIVE POINTS

We make a “universal” tip to fit all piles, as well as a wide selection of tips made to fit each of the most popular sheet piles used.

Weld Procedure

These points should be welded with a 5/16” fillet along the entire length of the top flange on both sides using 70xx series rod.

Features

- Universal Straight Bar
- Other types can be made

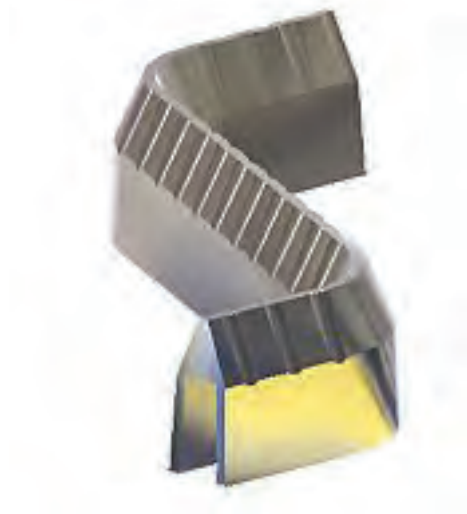



H-PILES



H-PILE SERIES

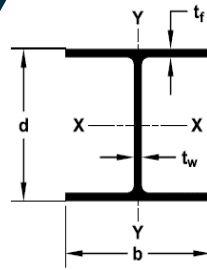

SECTION HP	Weight (m) lb/ft (kg/m)	Area (A) in ² (cm ²)	Depth (d) in (mm)	Flange Width (b) in (mm)	Thickness		Coating Area ft ² /ft (m ² /m)	ELASTIC PROPERTIES							
					Flange (t _f) in (mm)	Web (t _w) in (mm)		AXIS X-X				AXIS Y-Y			
								I in ⁴ (cm ⁴)	S in ³ (cm ³)	Z in ³ (cm ³)	r in (cm)	I in ⁴ (cm ⁴)	S in ³ (cm ³)	Z in ³ (cm ³)	r in (cm)
8X8 HP 200	36	10.6	8.02	8.16	0.445	0.445	3.92	119	29.8	33.6	3.36	40.3	9.88	15.2	1.95
	54	68.4	204	207	11.3	11.3	1.19	4953	488	550.6	8.53	1677	162	249.1	4.95
10X10 HP 250	42	12.4	9.70	10.10	0.420	0.415	4.83	210	43.4	48.3	4.13	71.7	14.2	21.8	2.41
	63	80.0	246	257	10.7	10.5	1.47	8741	711	791.5	10.5	2984	233	357.2	6.12
	57	16.7	9.99	10.20	0.565	0.565	4.91	294	58.8	66.5	4.18	101	19.7	30.3	2.45
	85	108	254	259	14.4	14.4	1.50	12237	964	1089.7	10.6	4204	323	496.5	6.22
12X12 HP 310	53	15.5	11.80	12.00	0.435	0.435	5.82	393	66.7	74.0	5.03	127	21.1	32.2	2.86
	79	100	300	305	11.0	11.0	1.77	16358	1093	1212.6	12.8	5286	346	527.7	7.26
	63	18.4	11.90	12.10	0.515	0.515	5.86	472	79.1	88.3	5.06	153	25.3	38.7	2.88
	94	119	302	307	13.1	13.1	1.79	19646	1296	1447.0	12.9	6368	415	634.2	7.32
	74	21.8	12.10	12.20	0.610	0.605	5.91	569	93.8	105	5.11	186	30.4	46.6	2.92
	110	141	307	310	15.5	15.4	1.80	23683	1537	1720.6	13.0	7742	498	763.6	7.42
	84	24.6	12.30	12.30	0.685	0.685	5.97	650	106	120	5.14	213	34.6	53.2	2.94
	125	159	312	312	17.4	17.4	1.82	27055	1737	1966.4	13.1	8866	567	871.8	7.47
	89	25.9	12.36	12.32	0.720	0.720	6.04	689	111.6	126.3	5.16	225	36.5	56.2	2.94
	132	167	314	313	18.3	18.3	1.84	28700	1830	2070	13.1	9370	599	922	7.48
14X14 HP 360	102	29.9	12.56	12.64	0.819	0.819	6.17	811	129.3	147.6	5.20	276	43.7	67.1	3.04
	152	193	319	321	20.8	20.8	1.88	33800	2120	2420	13.2	11500	716	1100	7.71
	117	34.4	12.76	12.87	0.929	0.929	6.26	946	148.2	170.8	5.24	331	51.4	79.3	3.11
	174	222	324	327	23.6	23.6	1.91	39400	2430	2800	13.3	13800	843	1300	7.89
	73	21.4	13.60	14.60	0.505	0.505	6.96	729	107	118	5.84	261	35.8	54.6	3.49
	109	138	345	371	12.8	12.8	2.12	30343	1753	1933.7	14.8	10864	587	894.7	8.86
16X16 HP 410	88	25.8	15.30	15.70	0.540	0.540	7.52	1110	145	161	6.56	349	44.5	68.2	3.68
	131	167	389	399	13.7	13.7	2.29	46201	2376	2638.3	16.7	14526	729	1117.6	9.35
	101	29.9	15.50	15.80	0.625	0.625	7.56	1300	168	187	6.59	412	52.2	80.1	3.71
	150	193	394	401	15.9	15.9	2.30	54110	2753	3064.4	16.7	17149	855	1312.6	9.42
	121	35.8	15.80	15.90	0.750	0.750	7.62	1590	201	226	6.66	504	63.4	97.6	3.75
16X16 HP 410	180	231	401	404	19.1	19.1	2.32	66180	3294	3703.5	16.9	20978	1039	1599.4	9.53
	141	41.7	16.00	16.00	0.875	0.875	7.69	1870	234	264	6.70	599	74.9	116	3.79
	210	269	406	406	22.2	22.2	2.34	77835	3835	4326.2	17.0	24932	1227	1900.9	9.63

Please contact a JD Fields Representative for available material grades and delivery conditions.

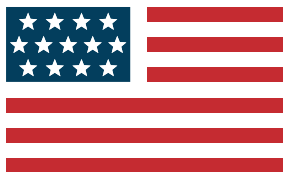

MADE IN USA

H-PILE ACCESSORIES

H-PILE POINTS

H-Pile points are made of high strength, low alloy cast steel. Cast steel is a superior material choice because it's isotropic – its properties are uniform in all directions. Cast steel points absorb impact and transfer it uniformly to the end of the pile.

Tips are pre-beveled, eliminating pile end preparation. The weld prep is already built into the point; our castings have a 45 degree weld chamfer so there is no need to chamfer piles.

Weld Procedure

1. To ensure proper seating of the tip, remove all flash from end of pile and insert tip.
2. Using a 70xx series rod, make a single pass weld across each flange on the outside only.
3. Do not weld web or inside of flanges.
4. For heavier sections, you may want to use multiple welding passes.

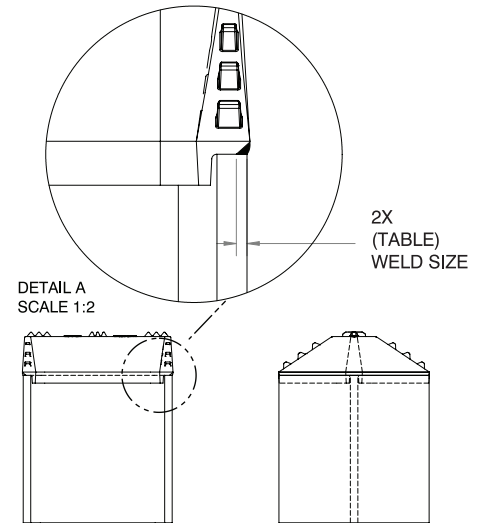
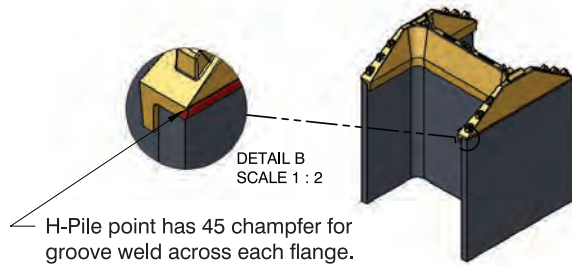

H-PILE SPLICER

H-Pile splicers save time during driving of long piles by eliminating the need for a full penetration weld. Made in ASTM A572 GR.50 or higher strength if requested.

Weld Procedure

1. Cut 1.0" wide x 1.0" long notch in center of web of one pile.
2. Chamfer outside edges of flanges on ends of one or both piles to be spliced. Make chamfer to about 1/2 material thickness.
3. Insert splicer on first pile making sure bolt is completely inside notch.
4. Install the next section of pile and tighten bolt.
5. Using a 70xx series rod, weld the flanges of splicer to the flanges of the pile with (TABLE)" by 3" vertical fillets.
6. Weld the outside flanges of the piles to complete.

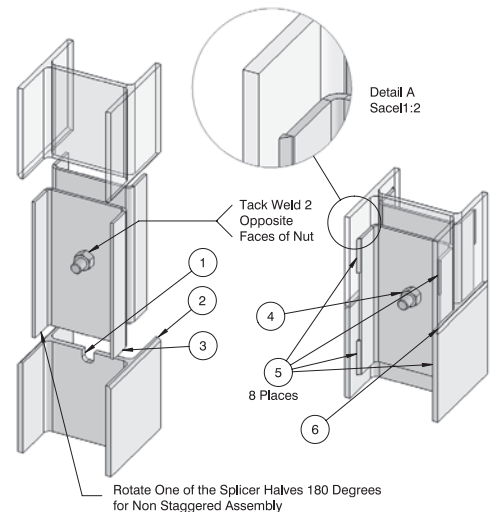

H-PILE ACCESSORIES

H-PILE POINT

Dimensions

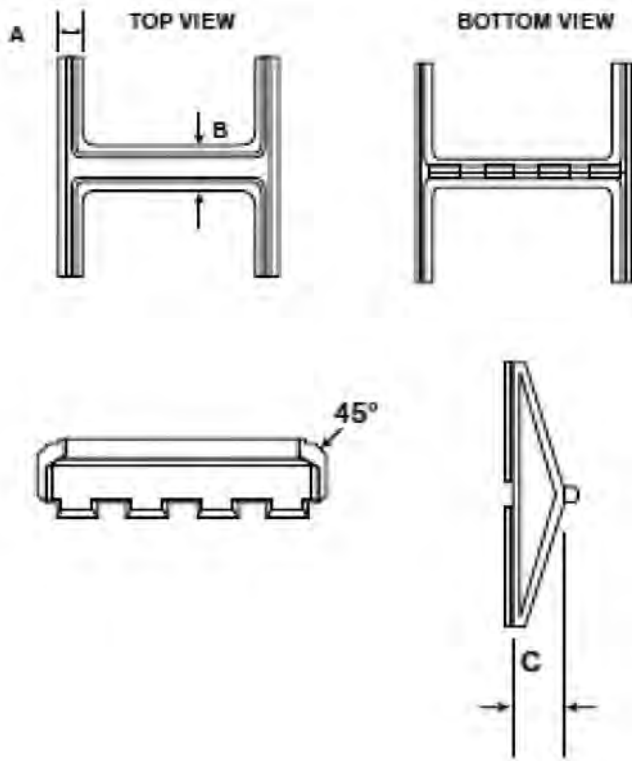

ASTM A148 90/60 - Heat Treated			
	10"	12"	14"
A	1"	1-1/4"	1-1/4"
B	1-1/4"	1-7/16"	1-3/4"
C	2-9/16"	2-5/8"	2-15/16"
WT	14	23	30

Normal Foundry Tolerances Apply

Installation Instructions

1. Fit point onto the end of the square cut pile end.
2. Weld point to the pile in either flat or vertical position using E70XX electrodes or equivalent filler material.
3. Weld across full width of flange following chart below for minimum size weld.

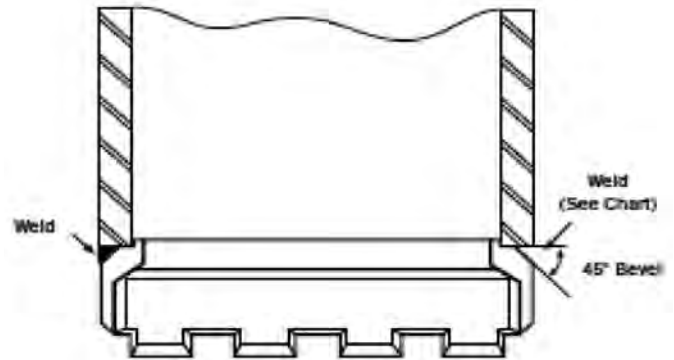

Pile Size	Flange Thickness	Minimum Size Groove Weld
HP 14 x 117	.805	7/16
HP 14 x 102	.705	3/8
HP 14 x 89	.615	3/8
HP 14 x 73	.505	5/16
HP 12 x 84	.685	3/8
HP 12 x 74	.610	3/8
HP 12 x 63	.515	5/16
HP 12 x 53	.435	5/16
HP 10 x 57	.565	5/16
HP 10 x 42	.420	5/16





PIPE PILES: SPIRALWELD

SPIRALWELD PIPE

OD in (mm)	Wall Thickness in (mm)																
	0.2813	0.3125	0.3438	0.3750	0.4063	0.4375	0.4688	0.5000	0.5625	0.6250	0.6875	0.7500	0.8125	0.8750	0.9375	1.0000	
	7.144	7.938	8.731	9.525	10.319	11.113	11.906	12.700	14.288	15.875	14.463	19.050	20.638	22.225	23.813	25.400	
16	47.27	52.41	57.54	62.64	67.73	72.78	77.83	82.85									
406.4	70.45	78.13	85.76	93.37	100.95	108.50	116.01	123.50									
20	59.30	65.77	72.24	78.67	85.10	91.49	97.88	104.23	116.88	129.45							
508.0	88.38	98.05	107.67	117.27	126.85	136.39	145.89	155.37	174.24	192.97							
24	71.32	79.13	86.94	94.71	102.48	110.20	117.93	125.61	140.93	156.17	171.33	186.41					
609.6	106.31	117.97	129.58	141.18	152.74	164.28	175.77	187.24	210.09	232.81	212.60	277.87					
30	89.37	99.17	108.99	118.76	128.54	138.26	147.99	157.68	177.01	196.26	215.43	234.51	253.51	272.43	291.26	310.01	
762.0	133.20	147.85	162.45	177.03	191.59	206.11	220.59	235.05	263.88	292.56	267.05	349.58	377.92	406.11	434.19	462.13	
36		119.22	131.04	142.81	154.60	166.32	178.06	189.75	213.09	236.35	259.52	282.62	305.63	328.55	351.39	374.15	
914.4		177.73	195.31	212.89	230.43	247.94	265.40	282.85	317.66	352.32	321.49	421.29	455.60	489.77	523.83	557.74	
42			153.10	166.86	180.66	194.38	208.13	221.82	249.17	276.44	303.62	330.72	357.74	384.67	411.52	438.29	
1,066.8			228.18	248.74	269.28	289.78	310.22	330.66	371.45	412.08	375.93	493.00	533.29	573.43	613.47	653.35	
48				190.92	206.72	222.44	238.20	253.89	285.25	316.52	347.72	378.83	409.85	440.80	471.65	502.43	
1,219.2				284.60	308.12	331.61	355.04	378.47	425.23	471.84	430.38	564.71	610.98	657.09	703.10	748.97	
54					232.78	250.51	268.27	285.96	321.33	356.61	391.81	426.93	461.97	496.92	531.79	566.57	
1,371.6					346.96	373.44	399.86	426.27	479.01	531.60	484.82	636.42	688.66	740.75	792.74	844.58	
60						278.57	298.34	318.03	357.41	396.70	435.91	475.04	514.08	553.04	591.92	630.71	
1,524.0						415.27	444.67	474.08	532.80	591.35	539.26	708.13	766.35	824.41	882.38	940.19	
66								350.10	393.48	436.79	480.01	523.14	566.19	609.16	652.05	694.85	
1,676.4								521.89	586.58	651.11	593.70	779.84	844.04	908.07	972.02	1,035.80	
72									429.56	476.87	524.10	571.25	618.31	665.29	712.18	758.99	
1,828.8									640.37	710.87	648.15	851.55	921.73	991.73	1,061.66	1,131.42	
78										516.96	568.20	619.35	670.42	721.41	772.31	823.13	
1,981.2										770.63	702.59	923.26	999.41	1,075.39	1,151.30	1,227.03	
84											612.29	667.46	722.54	777.53	832.44	887.27	
2,133.6											757.03	994.97	1,077.10	1,159.06	1,240.94	1,322.64	
90												715.56	774.65	833.65	892.57	951.41	
2,286.0												1,066.68	1,154.79	1,242.72	1,330.58	1,418.26	
96													826.76	889.78	952.70	1,015.55	
2,438.4													1,232.47	1,326.38	1,420.21	1,513.87	
100														861.51	927.19	992.79	1,058.31
2,540.0														1,284.27	1,382.15	1,479.97	1,577.61

Intermediate, custom diameter sections are available upon request subject to minimum tonnage requirements. Please inquire with your JDF HDM sales representative for details.



INSIDE-FIT CONICAL PIPE POINTS

Inside-fit conical points are manufactured with 60 degree slope for optimum ease in penetration and even distribution of load. The conical points are slip fit and can accommodate schedule 80 and thicker wall pipe. There is an option of a blunt nose if desired.

Our conical points are easy to install with a slip-on fit. The design places the cross-sectional area directly below the wall of the pipe for maximum support during penetration. They are a more heavy-duty construction than other brands.

The inside-fit conical point has a weld prep built into the shoe. These tips are designed with a weld chamfer built into the casting. Slip shoe inside pipe and using a 70xx series rod weld a 5/16" or larger weld all around.

Weld Procedure

Welding for most sizes requires a simple 5/16" fillet weld using 70xx series rod all around the top of the flange.

Type Inside-Fit

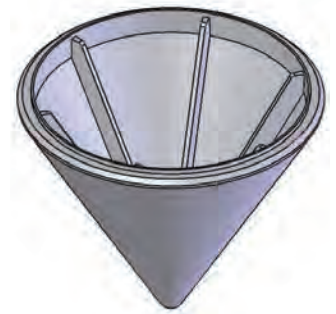

Conical Point and Pipe Cross-Section View

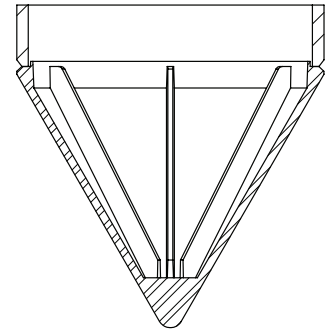

CAST STEEL PIPE SPLICERS

Cast steel splicers have the advantage of uniform sizing — there is no risk of improper fit, compared to fabricated splicers that are individually made. JDF Construction Products casts splicers in ASTM A 27, Grade 65/35, with ASTM A 148 grade 90-60 on request.

Weld Procedure

Pipe splicers are drive fit. Under proper conditions, the drive fit is water tight. If welding is desired, a simple 5/16" fillet using 70xx series rod at the top and bottom is all that is required.

Features

- Compression Fit
- Slip Fit

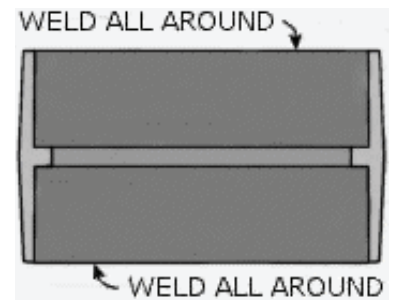

OPEN ENDED INSIDE-FIT CUTTING SHOES

Both of our cutting shoes are easy to install with a slip-on fit. The design places the cross-sectional area directly below the wall of the pipe for maximum support during penetration. They are a more heavy-duty construction than other brands. The inside-fit cutting shoe has a weld prep built into the shoe.

Weld Procedure

These tips are designed with a weld chamfer built into the casting. Slip shoe inside pipe and using a 70xx series rod weld a 5/16" weld all around.

Features

- Fits All Standard Pipe Sizes
- All Steel Alloy Grades

Inside-Fit



OPEN ENDED OUTSIDE-FIT CUTTING SHOES

Like our inside-fit shoe, this shoe has a slip-on fit, and the cross-sectional area lies below the wall of the pipe. The outside-fit cutting shoe has a natural fillet on top for easy welding.

Weld Procedure

These slip fit shoes are easily attached with a 5/16" fillet weld at the top of the flange. For best results, weld all around the shoe with a 70xx series rod.

Features

- Fits All Standard Pipe Sizes
- All Steel Alloy Grades

Outside-Fit



WELD/CHILL RINGS

We manufacture weld rings to fit all sizes of pipe and wall thicknesses. The standard weld ring is 1/8" thick.

Features

- Spherical Spacers
- Short or Long Pin Spacers
- Stainless and Carbon Steel

The inside diameter of a specific nominal pipe size will vary due to the difference in pipe wall thickness. The JDF Construction Products split commercial ring is designed to compensate for these variations. When inserted into the pipe, the ring can be closed at the split or have a gap, depending on the inside diameter of the pipe. These rings are also designed and manufactured with an opening at the split which permits the welder to compress the ring when it is inserted into the pipe. When released inside the pipe opening, the ring will spring back and make contact throughout the inside circumference of the pipe. The usual procedure followed when using our JDF Construction Products split commercial rings is to insert the ring into one end of the pipe, and then bring the other pipe over the opposite end of the ring, forcing both ends of both pipes against whatever root opening spacers are furnished on that ring.

Type LG
Type LG Ring Spacers
are removed in the
welding process

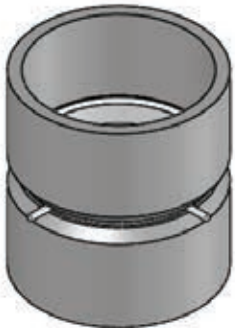

Type S
Type S Ring Spacers
may be removed or
melted into the weld

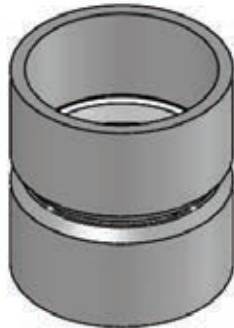

Type W
Type W Ring is
furnished without
spacers



NOTES

A large grid of graph paper for taking notes, consisting of 20 columns and 30 rows of small squares.



COMBINED WALL SYSTEMS



PIPE AZ COMBI-WALL SYSTEM

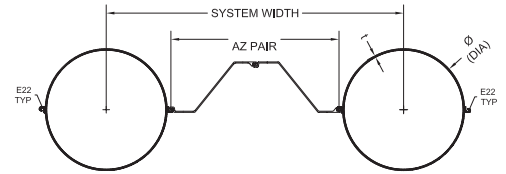

PIPE AZ18-800	Sheet Pile Section	Pipe-Sheet Connector	System Width	Per Unit of Wall			50 ksi	60 ksi	Mass: Beam/Sheet Ratio			Coating Area	
				Cross Sectional Area (A)	Combined Moment of Inertia (Iy)	Combined Elastic Modulus (Sx)	Ultimate Bend. Moment (Mmax)	PIPE / AZ 60% (m) ²	PIPE / AZ 80% (m) ²	PIPE / AZ 100% (m) ²	Waterside Surface (A')	Landside Surface (A'')	
				mm	cm ²	cm ⁴ /m	cm ³ /m	kN-m/m	kg/m ²	kg/m ²	kg/m ²	m ² /m	m ² /m
	in	in ²	in ⁴ /ft	in ³ /ft	kip-ft/ft	lbs/ft ²	lbs/ft ²	lbs/ft ²	ft ² /ft	ft ² /ft			
JDF 30 ODx0.500/AZ18-800	AZ18-800	E22	2422 95.35	1336.2 81.5	113956 834	2991.0 55.6	1031.5 231.8	1237.7 278.2	142.0 29.1	157.0 32.2	172.0 35.2	3.28 10.75	3.28 10.75
JDF 30 ODx0.625/AZ18-800	AZ18-800	E22	2422 95.35	1522.0 92.9	134266 983	3524.1 65.5	1215.3 273.1	1458.3 327.7	165.7 33.9	180.7 37.0	195.7 40.1	3.28 10.75	3.28 10.75
JDF 30 ODx0.750/AZ18-800	AZ18-800	E22	2422 95.35	1706.2 104.1	154053 1128	4043.4 75.2	1394.4 313.4	1673.3 376.0	189.2 38.7	204.2 41.8	219.2 44.9	3.28 10.75	3.28 10.75
JDF 36 ODx0.500/AZ18-800	AZ18-800	E22	2574 101.35	1490.6 91.0	167744 1228	3668.9 68.2	1265.3 284.3	1518.3 341.2	152.1 31.2	166.2 34.0	180.4 36.9	3.52 11.53	3.52 11.53
JDF 36 ODx0.625/AZ18-800	AZ18-800	E22	2574 101.35	1715.0 104.7	201410 1475	4405.3 81.9	1519.2 341.4	1823.0 409.7	179.0 36.7	193.2 39.6	207.3 42.5	3.52 11.53	3.52 11.53
JDF 36 ODx0.750/AZ18-800	AZ18-800	E22	2574 101.35	1937.9 118.3	234356 1716	5125.9 95.3	1767.7 397.3	2121.2 476.7	205.8 42.1	219.9 45.0	234.0 47.9	3.52 11.53	3.52 11.53
JDF 40 ODx0.500/AZ18-800	AZ18-800	E22	2676 105.35	1593.6 97.2	212965 1560	4192.2 78.0	1445.7 324.9	1734.9 389.9	158.2 32.4	171.8 35.2	185.4 38.0	3.67 12.06	3.67 12.06
JDF 40 ODx0.625/AZ18-800	AZ18-800	E22	2676 105.35	1843.7 112.5	257824 1888	5075.3 94.4	1750.2 393.3	2100.3 472.0	187.1 38.3	200.7 41.1	214.3 43.9	3.67 12.06	3.67 12.06
JDF 40 ODx0.750/AZ18-800	AZ18-800	E22	2676 105.35	2092.3 127.7	301822 2210	5941.4 110.5	2048.9 460.5	2458.7 552.6	215.8 44.2	229.4 47.0	243.0 49.8	3.67 12.06	3.67 12.06
JDF 42 ODx0.500/AZ18-800	AZ18-800	E22	2727 107.35	1645.1 100.4	238502 1747	4471.4 83.2	1542.0 346.5	1850.4 415.8	161.1 33.0	174.4 35.7	187.8 38.5	3.75 12.32	3.75 12.32
JDF 42 ODx0.625/AZ18-800	AZ18-800	E22	2727 107.35	1908.1 116.4	289675 2121	5430.7 101.0	1872.8 420.9	2247.4 505.1	190.9 39.1	204.3 41.8	217.6 44.6	3.75 12.32	3.75 12.32
JDF 42 ODx0.750/AZ18-800	AZ18-800	E22	2727 107.35	2169.5 132.4	339914 2489	6372.6 118.5	2197.6 493.9	2637.1 592.7	220.5 45.2	233.9 47.9	247.2 50.6	3.75 12.32	3.75 12.32
JDF 44 ODx0.500/AZ18-800	AZ18-800	E22	2778 109.35	1696.5 103.5	266036 1948	4760.8 88.6	1641.8 369.0	1970.2 442.8	163.9 33.6	177.0 36.2	190.1 38.9	3.83 12.58	3.83 12.58
JDF 44 ODx0.625/AZ18-800	AZ18-800	E22	2778 109.35	1972.4 120.4	324013 2373	5798.4 107.9	1999.6 449.4	2399.5 539.3	194.6 39.9	207.7 42.5	220.8 45.2	3.83 12.58	3.83 12.58
JDF 44 ODx0.750/AZ18-800	AZ18-800	E22	2778 109.35	2246.7 137.1	380982 2790	6817.9 126.8	2351.2 528.4	2821.4 634.1	225.1 46.1	238.2 48.8	251.3 51.5	3.83 12.58	3.83 12.58
JDF 48 ODx0.500/AZ18-800	AZ18-800	E22	2879 113.35	1799.5 109.8	327215 2396	5367.7 99.8	1851.1 416.0	2221.3 499.2	169.1 34.6	181.8 37.2	194.4 39.8	3.99 13.10	3.99 13.10
JDF 48 ODx0.625/AZ18-800	AZ18-800	E22	2879 113.35	2101.1 128.2	400306 2931	6566.7 122.1	2264.6 508.9	2717.5 610.7	201.5 41.3	214.2 43.9	226.8 46.5	3.99 13.10	3.99 13.10
JDF 48 ODx0.750/AZ18-800	AZ18-800	E22	2879 113.35	2401.2 146.5	472234 3458	7746.6 144.1	2671.5 600.4	3205.7 720.4	233.7 47.9	246.4 50.5	259.0 53.0	3.99 13.10	3.99 13.10
JDF 52 ODx0.625/AZ18-800	AZ18-800	E22	2981 117.35	2229.9 136.1	486985 3566	7374.1 137.2	2543.0 571.5	3051.6 685.8	208.0 42.6	220.2 45.1	232.4 47.6	4.15 13.63	4.15 13.63
JDF 52 ODx0.750/AZ18-800	AZ18-800	E22	2981 117.35	2555.6 156.0	575921 4217	8720.8 162.2	3007.4 675.9	3608.9 811.0	241.8 49.5	254.0 52.0	266.2 54.5	4.15 13.63	4.15 13.63
JDF 52 ODx0.875/AZ18-800	AZ18-800	E22	2981 117.35	2879.8 175.7	663545 4859	10047.6 186.9	3465.0 778.7	4158.0 934.4	275.4 56.4	287.6 58.9	299.8 61.4	4.15 13.63	4.15 13.63
JDF 56 ODx0.750/AZ18-800	AZ18-800	E22	3082 121.35	2710.1 165.4	692339 5070	9734.8 181.1	3357.1 754.5	4028.5 905.3	249.3 51.1	261.1 53.5	272.9 55.9	4.31 14.15	4.31 14.15
JDF 56 ODx0.875/AZ18-800	AZ18-800	E22	3082 121.35	3060.0 186.7	798906 5850	11233.2 208.9	3873.8 870.6	4648.6 1044.7	284.4 58.2	296.2 60.7	308.0 63.1	4.31 14.15	4.31 14.15
JDF 56 ODx1.00/AZ18-800	AZ18-800	E22	3082 121.35	3408.3 208.0	904010 6620	12711.1 236.4	4383.5 985.1	5260.1 1182.1	319.3 65.4	331.1 67.8	342.9 70.2	4.31 14.15	4.31 14.15
JDF 60 ODx0.750/AZ18-800	AZ18-800	E22	3184 125.35	2864.5 174.8	821750 6018	10784.1 200.6	3718.9 835.8	4462.7 1002.9	256.3 52.5	267.7 54.8	279.2 57.2	4.47 14.67	4.47 14.67
JDF 60 ODx0.875/AZ18-800	AZ18-800	E22	3184 125.35	3240.2 197.7	949400 6952	12459.3 231.7	4296.6 965.6	5156.0 1158.7	292.8 60.0	304.2 62.3	315.6 64.6	4.47 14.67	4.47 14.67
JDF 60 ODx1.00/AZ18-800	AZ18-800	E22	3184 125.35	3614.2 220.6	1075416 7875	14113.1 262.5	4867.0 1093.8	5840.3 1312.5	329.1 67.4	340.5 69.7	351.9 72.1	4.47 14.67	4.47 14.67
JDF 64 ODx0.750/AZ18-800	AZ18-800	E22	3286 129.35	3019.0 184.2	964380 7062	11864.9 220.7	4091.7 919.5	4910.0 1103.4	262.9 53.9	274.0 56.1	285.1 58.4	4.63 15.20	4.63 15.20
JDF 64 ODx0.875/AZ18-800	AZ18-800	E22	3286 129.35	3420.4 208.7	1115294 8167	13721.6 255.2	4732.0 1063.4	5678.4 1276.1	300.7 61.6	311.7 63.9	322.8 66.1	4.63 15.20	4.63 15.20
JDF 64 ODx1.00/AZ18-800	AZ18-800	E22	3286 129.35	3820.1 233.1	1264400 9259	15556.1 289.3	5364.6 1205.6	6437.5 1446.7	338.3 69.3	349.3 71.6	360.4 73.8	4.63 15.20	4.63 15.20
JDF 68 ODx0.750/AZ18-800	AZ18-800	E22	3387 133.35	3173.4 193.7	1120429 8205	12973.9 241.3	4474.1 1005.5	5368.9 1206.6	269.1 55.1	279.9 57.3	290.6 59.5	4.79 15.72	4.79 15.72
JDF 68 ODx0.875/AZ18-800	AZ18-800	E22	3387 133.35	3600.5 219.7	1296823 9496	15016.5 279.3	5178.5 1163.8	6214.2 1396.5	308.1 63.1	318.8 65.8	329.6 67.5	4.79 15.72	4.79 15.72
JDF 68 ODx1.00/AZ18-800	AZ18-800	E22	3387 133.35	4026.1 245.7	1471232 10774	17036.0 316.9	5874.9 1320.3	7049.9 1584.4	346.9 71.1	357.7 73.3	368.4 75.5	4.79 15.72	4.79 15.72
JDF 72 ODx0.750/AZ18-800	AZ18-800	E22	3489 137.35	3327.9 203.1	1290075 9447	14108.4 262.4	4865.4 1093.4	5838.4 1312.1	275.0 56.3	285.4 58.5	295.8 60.6	4.95 16.24	4.95 16.24
JDF 72 ODx0.875/AZ18-800	AZ18-800	E22	3489 137.35	3780.7 230.7	1494197 10942	16340.7 303.9	5635.2 1266.4	6762.2 1519.7	315.1 64.5	325.5 66.7	335.9 68.8	4.95 16.24	4.95 16.24
JDF 72 ODx1.00/AZ18-800	AZ18-800	E22	3489 137.35	4232.0 258.3	1696152 12421	18549.4 345.0	6396.8 1437.6	7676.2 1725.1	355.0 72.7	365.5 74.9	375.9 77.0	4.95 16.24	4.95 16.24

* Larger, custom pipe sizes and wall thicknesses are available upon request. Please contact us at eng@jdfields.com for availability.

PIPE AZ COMBI-WALL SYSTEM

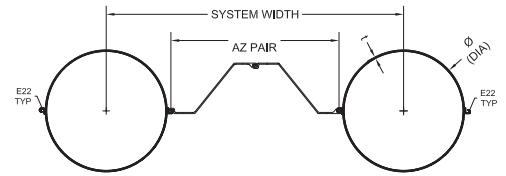

PIPE AZ23-800	Sheet Pile Section	Pipe-Sheet Connector	System Width	Per Unit of Wall			50 ksi	60 ksi	Mass: Beam/Sheet Ratio			Coating Area	
				Cross Sectional Area (A)	Combined Moment of Inertia (Iy)	Combined Elastic Modulus (Sx)	Ultimate Bend. Moment (Mmax)	PIPE / AZ 60% (m) ²	PIPE / AZ 80% (m) ²	PIPE / AZ 100% (m) ²	Waterside Surface (A ²)	Landside Surface (A ²)	
				mm	cm ²	cm ⁴ /m	cm ³ /m	kN-m/m	kg/m ²	kg/m ²	kg/m ²	m ² /ft	m ² /m
	in	in ²	in ⁴ /ft	in ³ /ft	kip-ft/ft	lbs/ft ²	lbs/ft ²	lbs/ft ²	ft ² /ft	ft ² /ft			
JDF 30 ODx0.500/AZ23-800	AZ23-800	E22	2422 95.35	1455.5 88.8	123159 902	3232.5 60.1	1114.7 250.5	1337.7 300.6	148.8 30.5	166.1 34.0	183.4 37.6	3.31 10.87	3.31 10.87
JDF 30 ODx0.625/AZ23-800	AZ23-800	E22	2422 95.35	1641.3 100.2	143469 1051	3765.6 70.0	1298.6 291.8	1558.3 350.2	172.5 35.3	189.8 42.4	207.1 42.4	3.31 10.87	3.31 10.87
JDF 30 ODx0.750/AZ23-800	AZ23-800	E22	2422 95.35	1825.6 111.4	163256 1196	4284.9 79.7	1477.7 332.1	1773.2 398.5	196.0 40.1	213.3 43.7	230.6 47.2	3.31 10.87	3.31 10.87
JDF 36 ODx0.500/AZ23-800	AZ23-800	E22	2574 101.35	1610.0 98.2	176402 1292	3858.3 71.8	1330.6 299.0	1596.7 358.8	158.5 32.5	174.8 35.8	191.2 39.1	3.55 11.65	3.55 11.65
JDF 36 ODx0.625/AZ23-800	AZ23-800	E22	2574 101.35	1834.4 111.9	210068 1538	4594.7 85.5	1584.5 356.1	1901.4 427.3	185.5 38.0	201.8 41.3	218.1 44.7	3.55 11.65	3.55 11.65
JDF 36 ODx0.750/AZ23-800	AZ23-800	E22	2574 101.35	2057.2 125.5	243014 1780	5315.3 98.9	1833.0 411.9	2199.6 494.3	212.2 43.5	228.5 46.8	244.8 50.1	3.55 11.65	3.55 11.65
JDF 40 ODx0.500/AZ23-800	AZ23-800	E22	2676 105.35	1712.9 104.5	221295 1621	4356.2 81.0	1502.3 337.6	1802.7 405.1	164.4 33.7	180.1 36.9	195.8 40.1	3.71 12.18	3.71 12.18
JDF 40 ODx0.625/AZ23-800	AZ23-800	E22	2676 105.35	1963.1 119.8	266153 1949	5239.2 97.5	1806.8 406.0	2168.1 487.3	193.3 39.6	209.0 42.8	224.6 46.0	3.71 12.18	3.71 12.18
JDF 40 ODx0.750/AZ23-800	AZ23-800	E22	2676 105.35	2211.7 135.0	310151 2271	6105.3 113.6	2105.5 473.2	2526.5 567.8	222.0 45.4	237.7 48.7	253.3 51.9	3.71 12.18	3.71 12.18
JDF 42 ODx0.500/AZ23-800	AZ23-800	E22	2727 107.35	1764.4 107.7	246677 1806	4624.6 86.0	1594.8 358.4	1913.8 430.1	167.2 34.2	182.6 37.4	197.9 40.5	3.79 12.44	3.79 12.44
JDF 42 ODx0.625/AZ23-800	AZ23-800	E22	2727 107.35	2027.5 123.7	297849 2181	5584.0 103.9	1925.7 432.8	2310.8 519.3	197.0 40.3	212.4 43.5	227.7 46.6	3.79 12.44	3.79 12.44
JDF 42 ODx0.750/AZ23-800	AZ23-800	E22	2727 107.35	2288.9 139.7	348088 2549	6525.8 121.4	2250.5 505.8	2700.6 606.9	226.6 46.4	242.0 49.6	257.4 52.7	3.79 12.44	3.79 12.44
JDF 44 ODx0.500/AZ23-800	AZ23-800	E22	2778 109.35	1815.9 110.8	274061 2007	4904.5 91.2	1691.3 380.1	2029.6 456.1	169.9 34.8	185.0 37.9	200.0 41.0	3.87 12.70	3.87 12.70
JDF 44 ODx0.625/AZ23-800	AZ23-800	E22	2778 109.35	2091.8 127.7	332038 2431	5942.0 110.5	2049.1 460.5	2458.9 552.6	200.6 41.1	215.6 44.2	230.7 47.3	3.87 12.70	3.87 12.70
JDF 44 ODx0.750/AZ23-800	AZ23-800	E22	2778 109.35	2366.1 144.4	389007 2849	6961.5 129.5	2400.7 539.5	2880.8 647.4	231.1 47.3	246.2 50.4	261.3 53.5	3.87 12.70	3.87 12.70
JDF 48 ODx0.500/AZ23-800	AZ23-800	E22	2879 113.35	1918.9 117.1	334956 2453	5494.7 102.2	1894.9 425.8	2273.8 511.0	174.9 35.8	189.5 38.8	204.0 41.8	4.03 13.22	4.03 13.22
JDF 48 ODx0.625/AZ23-800	AZ23-800	E22	2879 113.35	2220.5 135.5	408048 2988	6693.7 124.5	2308.3 518.8	2770.0 622.5	207.3 42.5	221.9 45.4	236.4 48.4	4.03 13.22	4.03 13.22
JDF 48 ODx0.750/AZ23-800	AZ23-800	E22	2879 113.35	2520.6 153.8	479976 3515	7873.6 146.5	2715.2 610.2	3258.3 732.3	239.5 49.1	254.1 52.0	268.6 55.0	4.03 13.22	4.03 13.22
JDF 52 ODx0.625/AZ23-800	AZ23-800	E22	2981 117.35	2349.2 143.4	494463 3621	7487.3 139.3	2582.0 580.3	3098.4 696.3	213.6 43.7	227.6 46.6	241.7 49.5	4.19 13.75	4.19 13.75
JDF 52 ODx0.750/AZ23-800	AZ23-800	E22	2981 117.35	2675.0 163.2	583398 4272	8834.0 164.3	3046.4 684.6	3655.7 821.6	247.3 50.7	261.4 53.5	275.5 56.4	4.19 13.75	4.19 13.75
JDF 52 ODx0.875/AZ23-800	AZ23-800	E22	2981 117.35	2999.2 183.0	671023 4914	10160.9 189.0	3504.0 787.5	4204.8 945.0	280.9 57.5	295.0 60.4	309.1 63.3	4.19 13.75	4.19 13.75
JDF 56 ODx0.750/AZ23-800	AZ23-800	E22	3082 121.35	2829.4 172.7	699571 5123	9836.5 183.0	3392.2 762.3	4070.6 914.8	254.7 52.2	268.3 54.9	281.9 57.7	4.35 14.27	4.35 14.27
JDF 56 ODx0.875/AZ23-800	AZ23-800	E22	3082 121.35	3179.4 194.0	806137 5903	11334.9 210.8	3908.9 878.5	4690.7 1054.2	289.8 59.3	303.4 62.1	317.0 64.9	4.35 14.27	4.35 14.27
JDF 56 ODx1.00/AZ23-800	AZ23-800	E22	3082 121.35	3527.7 215.3	911241 6673	12812.7 238.3	4418.5 993.0	5302.2 1191.6	324.7 66.5	338.3 69.3	351.9 72.1	4.35 14.27	4.35 14.27
JDF 60 ODx0.750/AZ23-800	AZ23-800	E22	3184 125.35	2983.9 182.1	828751 6069	10876.0 202.3	3750.6 842.9	4500.8 1011.5	261.5 53.6	274.7 56.3	287.9 59.0	4.51 14.79	4.51 14.79
JDF 60 ODx0.875/AZ23-800	AZ23-800	E22	3184 125.35	3359.5 205.0	956400 7004	12551.2 233.5	4328.3 972.7	5194.0 1167.3	298.0 61.0	311.2 63.7	324.3 66.4	4.51 14.79	4.51 14.79
JDF 60 ODx1.00/AZ23-800	AZ23-800	E22	3184 125.35	3733.6 227.8	1082417 7926	14205.0 264.2	4898.6 1100.9	5878.4 1321.1	334.3 68.5	347.5 71.2	360.6 73.9	4.51 14.79	4.51 14.79
JDF 64 ODx0.75/AZ23-800	AZ23-800	E22	3286 129.35	3138.3 191.5	971164 7112	11948.4 222.2	4120.4 926.0	4944.5 1111.2	268.0 54.9	280.7 57.5	293.5 60.1	4.67 15.32	4.67 15.32
JDF 64 ODx0.875/AZ23-800	AZ23-800	E22	3286 129.35	3539.7 216.0	1122078 8217	13805.1 256.8	4760.7 1069.9	5712.9 1283.9	305.7 62.6	318.5 65.2	331.2 67.8	4.67 15.32	4.67 15.32
JDF 64 ODx1.00/AZ23-800	AZ23-800	E22	3286 129.35	3939.5 240.4	1271184 9309	15639.6 290.9	5393.4 1212.1	6472.0 1454.5	343.3 70.3	356.1 72.9	368.8 75.5	4.67 15.32	4.67 15.32
JDF 68 ODx0.750/AZ23-800	AZ23-800	E22	3387 133.35	3292.8 200.9	1127010 8253	13050.1 242.7	4500.4 1011.4	5400.5 1213.7	274.0 56.1	286.4 58.7	298.8 61.2	4.83 15.84	4.83 15.84
JDF 68 ODx0.875/AZ23-800	AZ23-800	E22	3387 133.35	3719.9 227.0	1303404 9545	15092.7 280.7	5204.8 1169.7	6245.7 1403.6	313.0 64.1	325.4 66.6	337.7 69.2	4.83 15.84	4.83 15.84
JDF 68 ODx1.00/AZ23-800	AZ23-800	E22	3387 133.35	4145.4 253.0	1477812 10822	17112.2 318.3	5901.2 1326.2	7081.5 1591.4	351.8 72.1	364.2 74.6	376.6 77.1	4.83 15.84	4.83 15.84
JDF 72 ODx0.750/AZ23-800	AZ23-800	E22	3489 137.35	3447.2 210.4	1296464 9494	14178.3 263.7	4889.4 1098.8	5867.3 1318.6	279.7 57.3	291.7 59.8	303.8 62.2	4.99 16.36	4.99 16.36
JDF 72 ODx0.875/AZ23-800	AZ23-800	E22	3489 137.35	3900.1 238.0	1500586 10989	16410.6 305.2	5659.3 1271.8	6791.1 1526.2	319.8 65.5	331.9 68.0	343.9 70.4	4.99 16.36	4.99 16.36
JDF 72 ODx1.00/AZ23-800	AZ23-800	E22	3489 137.35	4351.4 265.5	1702541 12468	18619.2 346.3	6420.9 1443.0	7705.1 1731.6	359.8 73.7	371.8 76.2	383.8 78.6	4.99 16.36	4.99 16.36

* Larger, custom pipe sizes and wall thicknesses are available upon request. Please contact us at eng@jdfields.com for availability.

PIPE AZ COMBI-WALL SYSTEM

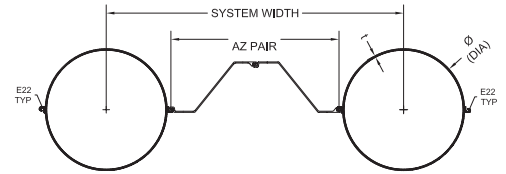

PIPE AZ28-750	Sheet Pile Section	Pipe-Sheet Connector	System Width	Per Unit of Wall			50 ksi	60 ksi	Mass: Beam/Sheet Ratio			Coating Area	
				Cross Sectional Area (A)	Combined Moment of Inertia (Iy)	Combined Elastic Modulus (Sx)	Ultimate Bend. Moment (Mmax)	PIPE / AZ 60% (m) ²	PIPE / AZ 80% (m) ²	PIPE / AZ 100% (m) ²	Waterside Surface (A ²)	Landside Surface (A ²)	
				mm	cm ²	cm ⁴ /m	cm ³ /m	kN-m/m	kg/m ²	kg/m ²	kg/m ²	m ² /m	m ² /m
	in	in ²	in ⁴ /ft	in ³ /ft	kip-ft/ft	lbs/ft ²	lbs/ft ²	lbs/ft ²	ft ² /ft	ft ² /ft			
JDF 30 ODx0.500/AZ28-750	AZ28-750	E22	2322 91.42	1466.5 89.5	136603 1000	3585.4 66.7	1236.4 277.9	1483.7 333.4	158.4 32.4	177.6 36.4	196.7 40.3	3.31 10.87	3.31 10.87
JDF 30 ODx0.625/AZ28-750	AZ28-750	E22	2322 91.42	1652.4 100.8	157788 1155	4141.4 77.0	1428.2 321.0	1713.8 385.2	183.2 37.5	202.3 41.4	221.4 45.3	3.31 10.87	3.31 10.87
JDF 30 ODx0.750/AZ28-750	AZ28-750	E22	2322 91.42	1836.6 112.1	178428 1307	4683.1 87.1	1615.0 362.9	1938.0 435.5	207.7 42.5	226.8 46.5	245.9 50.4	3.31 10.87	3.31 10.87
JDF 36 ODx0.500/AZ28-750	AZ28-750	E22	2474 97.42	1621.0 98.9	191170 1400	4181.3 77.8	1441.9 324.1	1730.3 388.9	168.0 34.4	185.9 38.1	203.9 41.8	3.55 11.65	3.55 11.65
JDF 36 ODx0.625/AZ28-750	AZ28-750	E22	2474 97.42	1845.4 112.6	226196 1656	4947.4 92.0	1706.1 383.4	2047.4 460.1	196.0 40.1	213.9 43.8	231.9 47.5	3.55 11.65	3.55 11.65
JDF 36 ODx0.750/AZ28-750	AZ28-750	E22	2474 97.42	2068.2 126.2	260475 1907	5697.2 106.0	1964.7 441.5	2357.6 529.8	223.8 45.8	241.8 49.5	259.7 53.2	3.55 11.65	3.55 11.65
JDF 40 ODx0.500/AZ28-750	AZ28-750	E22	2576 101.42	1724.0 105.2	237223 1737	4669.8 86.9	1610.4 361.9	1932.5 434.3	173.7 35.6	190.9 39.1	208.2 42.6	3.71 12.18	3.71 12.18
JDF 40 ODx0.625/AZ28-750	AZ28-750	E22	2576 101.42	1974.1 120.5	283823 2078	5587.1 103.9	1926.7 433.0	2312.1 519.6	203.7 41.7	220.9 45.3	238.2 48.8	3.71 12.18	3.71 12.18
JDF 40 ODx0.750/AZ28-750	AZ28-750	E22	2576 101.42	2222.7 135.6	329529 2413	6486.8 120.7	2237.0 502.7	2684.4 603.4	233.5 47.8	250.8 51.4	268.0 54.9	3.71 12.18	3.71 12.18
JDF 42 ODx0.500/AZ28-750	AZ28-750	E22	2627 103.42	1775.4 108.3	263263 1928	4935.6 91.8	1702.1 382.5	2042.5 459.0	176.4 36.1	193.3 39.6	210.2 43.1	3.79 12.44	3.79 12.44
JDF 42 ODx0.625/AZ28-750	AZ28-750	E22	2627 103.42	2038.5 124.4	316384 2317	5931.5 110.3	2045.5 459.7	2454.6 551.6	207.3 42.5	224.2 45.9	241.1 49.4	3.79 12.44	3.79 12.44
JDF 42 ODx0.750/AZ28-750	AZ28-750	E22	2627 103.42	2299.9 140.3	368535 2699	6909.2 128.5	2382.7 535.5	2859.2 642.6	238.1 48.8	255.0 52.2	271.9 55.7	3.79 12.44	3.79 12.44
JDF 44 ODx0.500/AZ28-750	AZ28-750	E22	2678 105.42	1826.9 111.5	291355 2134	5213.9 97.0	1798.1 404.1	2157.7 484.9	179.0 36.7	195.6 40.1	212.2 43.5	3.87 12.70	3.87 12.70
JDF 44 ODx0.625/AZ28-750	AZ28-750	E22	2678 105.42	2102.8 128.3	351498 2574	6290.2 117.0	2169.2 487.5	2603.1 585.0	210.8 43.2	227.4 46.6	244.0 50.0	3.87 12.70	3.87 12.70
JDF 44 ODx0.750/AZ28-750	AZ28-750	E22	2678 105.42	2377.1 145.1	410594 3007	7347.8 136.7	2533.9 569.5	3040.7 683.3	242.5 49.7	259.1 53.1	275.7 56.5	3.87 12.70	3.87 12.70
JDF 48 ODx0.500/AZ28-750	AZ28-750	E22	2779 109.42	1929.9 117.8	353810 2591	5804.0 108.0	2001.5 449.8	2401.8 539.8	183.9 37.7	199.9 40.9	215.8 44.2	4.03 13.22	4.03 13.22
JDF 48 ODx0.625/AZ28-750	AZ28-750	E22	2779 109.42	2231.5 136.2	429531 3145	7046.1 131.1	2429.9 546.1	2915.9 655.3	217.4 44.5	233.4 47.8	249.4 51.1	4.03 13.22	4.03 13.22
JDF 48 ODx0.750/AZ28-750	AZ28-750	E22	2779 109.42	2531.6 154.5	504047 3691	8268.5 153.8	2851.4 640.8	3421.7 769.0	250.8 51.4	266.8 54.6	282.7 57.9	4.03 13.22	4.03 13.22
JDF 52 ODx0.625/AZ28-750	AZ28-750	E22	2881 113.42	2360.2 144.0	518188 3795	7846.6 145.9	2705.9 608.1	3247.1 729.7	223.6 45.8	239.0 48.9	254.4 52.1	4.19 13.75	4.19 13.75
JDF 52 ODx0.750/AZ28-750	AZ28-750	E22	2881 113.42	2686.0 163.9	610211 4469	9240.0 171.9	3186.5 716.1	3823.8 859.3	258.5 52.9	273.9 56.1	289.3 59.3	4.19 13.75	4.19 13.75
JDF 52 ODx0.875/AZ28-750	AZ28-750	E22	2881 113.42	3010.2 183.7	700877 5132	10612.9 197.4	3659.9 822.5	4391.9 987.0	293.3 60.1	308.7 63.2	324.1 66.4	4.19 13.75	4.19 13.75
JDF 56 ODx0.750/AZ28-750	AZ28-750	E22	2982 117.42	2840.5 173.3	729365 5341	10255.4 190.8	3536.6 794.8	4243.9 953.8	265.7 54.4	280.6 57.5	295.5 60.5	4.35 14.27	4.35 14.27
JDF 56 ODx0.875/AZ28-750	AZ28-750	E22	2982 117.42	3190.4 194.7	839505 6148	11804.1 219.6	4070.7 914.8	4884.8 1097.8	302.0 61.8	316.9 64.9	331.7 67.9	4.35 14.27	4.35 14.27
JDF 56 ODx1.00/AZ28-750	AZ28-750	E22	2982 117.42	3538.7 215.9	948133 6943	13331.5 248.0	4597.4 1033.2	5516.9 1239.8	338.1 69.2	352.9 72.3	367.8 75.3	4.35 14.27	4.35 14.27
JDF 60 ODx0.750/AZ28-750	AZ28-750	E22	3084 121.42	2994.9 182.8	861752 6311	11309.1 210.4	3900.0 876.5	4680.0 1051.8	272.4 55.8	286.8 58.7	301.2 61.7	4.51 14.79	4.51 14.79
JDF 60 ODx0.875/AZ28-750	AZ28-750	E22	3084 121.42	3370.5 205.7	993541 7276	13038.6 242.5	4496.4 1010.5	5395.7 1212.6	310.1 63.5	324.5 66.5	338.9 69.4	4.51 14.79	4.51 14.79
JDF 60 ODx1.00/AZ28-750	AZ28-750	E22	3084 121.42	3744.6 228.5	1123644 8228	14746.0 274.3	5085.2 1142.8	6102.3 1371.4	347.6 71.2	361.9 74.1	376.3 77.1	4.51 14.79	4.51 14.79
JDF 64 ODx0.750/AZ28-750	AZ28-750	E22	3186 125.42	3149.3 192.2	1007584 7378	12396.5 230.6	4275.0 960.7	5130.0 1152.9	278.7 57.1	292.7 59.9	306.6 62.8	4.67 15.32	4.67 15.32
JDF 64 ODx0.875/AZ28-750	AZ28-750	E22	3186 125.42	3550.7 216.7	1163235 8518	14311.5 266.2	4935.4 1109.1	5922.4 1331.0	317.7 65.1	331.6 67.9	345.5 70.8	4.67 15.32	4.67 15.32
JDF 64 ODx1.00/AZ28-750	AZ28-750	E22	3186 125.42	3950.5 241.1	1317022 9644	16203.5 301.4	5587.8 1255.8	6705.4 1506.9	356.4 73.0	370.4 75.9	384.3 78.7	4.67 15.32	4.67 15.32
JDF 68 ODx0.750/AZ28-750	AZ28-750	E22	3287 129.42	3303.8 201.6	1167045 8546	13513.7 251.4	4660.3 1047.3	5592.3 1256.8	284.6 58.3	298.1 61.1	311.6 63.8	4.83 15.84	4.83 15.84
JDF 68 ODx0.875/AZ28-750	AZ28-750	E22	3287 129.42	3730.9 227.7	1348805 9877	15618.4 290.5	5386.1 1210.4	6463.3 1452.5	324.8 66.5	338.3 69.3	351.8 72.1	4.83 15.84	4.83 15.84
JDF 68 ODx1.00/AZ28-750	AZ28-750	E22	3287 129.42	4156.4 253.6	1528520 11193	17699.4 329.2	6103.7 1371.7	7324.5 1646.1	364.8 74.7	378.3 77.5	391.8 80.2	4.83 15.84	4.83 15.84
JDF 72 ODx0.750/AZ28-750	AZ28-750	E22	3389 133.42	3458.2 211.0	1340300 9815	14657.7 272.6	5054.8 1136.0	6065.7 1363.2	290.2 59.4	303.3 62.1	316.4 64.8	4.99 16.36	4.99 16.36
JDF 72 ODx0.875/AZ28-750	AZ28-750	E22	3389 133.42	3911.1 238.7	1550445 11354	16955.9 315.4	5847.3 1314.1	7016.8 1576.9	331.5 67.9	344.6 70.6	357.7 73.3	4.99 16.36	4.99 16.36
JDF 72 ODx1.00/AZ28-750	AZ28-750	E22	3389 133.42	4362.4 266.2	1758359 12876	19229.7 357.7	6631.4 1490.3	7957.7 1788.4	372.6 76.3	385.7 79.0	398.8 81.7	4.99 16.36	4.99 16.36

* Larger, custom pipe sizes and wall thicknesses are available upon request. Please contact us at eng@jdfields.com for availability.

PIPE PZC COMBI-WALL SYSTEM

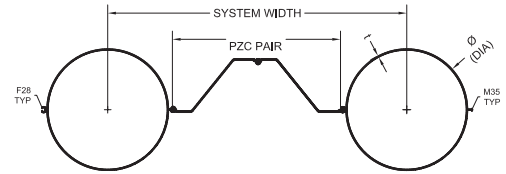

PIPE PZC13	Sheet Pile Section	Pipe-Sheet Connector	System Width	Per Unit of Wall			50 ksi	60 ksi	Mass: Beam/Sheet Ratio			Coating Area	
				Cross Sectional Area (A)	Combined Moment of Inertia (Iy)	Combined Elastic Modulus (Sx)	Ultimate Bend. Moment (Mmax)	PIPE / PZC 60% (m) ²	PIPE / PZC 80% (m) ²	PIPE / PZC 100% (m) ²	Waterside Surface (A')	Landside Surface (A'')	
				mm	cm ²	cm ⁴ /m	cm ³ /m	kN-m/m	kg/m ²	kg/m ²	kg/m ²	m ² /m	m ² /m
in	in ²	in ⁴ /ft	in ³ /ft	kip-ft/ft	lbs/ft ²	lbs/ft ²	lbs/ft ²	ft ² /ft	ft ² /ft				
JDF 30 ODx0.500/PZC13	PZC13	MF63	2241 88.23	1295.1 79.0	106762.0 781.8	2802.2 52.1	966.3 217.2	1159.6 260.6	149.0 30.5	163.8 33.6	178.6 36.6	2.90 9.53	2.90 9.53
JDF 30 ODx0.625/PZC13	PZC13	MF63	2241 88.23	1480.9 90.4	128711.6 942.5	3378.3 62.8	1165.0 261.8	1398.0 314.2	174.7 35.8	189.4 38.8	204.2 41.8	2.90 9.53	2.90 9.53
JDF 30 ODx0.750/PZC13	PZC13	MF63	2241 88.23	1665.1 101.6	150096.0 1099.1	3939.5 73.3	1358.6 305.3	1630.3 366.4	200.1 41.0	214.8 44.0	229.6 47.0	2.90 9.53	2.90 9.53
JDF 36 ODx0.500/PZC13	PZC13	MF63	2393 94.23	1449.6 88.5	165073.6 1208.8	3610.5 67.2	1245.1 279.8	1494.1 335.8	159.5 32.7	173.3 35.5	187.2 38.3	3.14 10.31	3.14 10.31
JDF 36 ODx0.625/PZC13	PZC13	MF63	2393 94.23	1674.0 102.2	201283.5 1474.0	4402.5 81.9	1518.2 341.2	1821.9 409.4	188.5 38.6	202.3 41.4	216.1 44.3	3.14 10.31	3.14 10.31
JDF 36 ODx0.750/PZC13	PZC13	MF63	2393 94.23	1896.8 115.8	236720.3 1733.5	5177.6 96.3	1785.5 401.3	2142.6 481.5	217.2 44.5	231.1 47.3	244.9 50.2	3.14 10.31	3.14 10.31
JDF 40 ODx0.500/PZC13	PZC13	MF63	2495 98.23	1552.5 94.7	213682.3 1564.8	4206.3 78.2	1450.6 326.0	1740.7 391.2	165.7 33.9	179.0 36.7	192.3 39.4	3.30 10.84	3.30 10.84
JDF 40 ODx0.625/PZC13	PZC13	MF63	2495 98.23	1802.7 110.0	261792.8 1917.1	5153.4 95.9	1777.2 399.4	2132.6 479.3	196.7 40.3	210.0 43.0	223.3 45.7	3.30 10.84	3.30 10.84
JDF 40 ODx0.750/PZC13	PZC13	MF63	2495 98.23	2051.3 125.2	308981.1 2262.6	6082.3 113.1	2097.5 471.4	2517.0 565.7	227.5 46.6	240.8 49.3	254.1 52.0	3.30 10.84	3.30 10.84
JDF 44 ODx0.500/PZC13	PZC13	MF63	2597 102.23	1655.5 101.0	270422.0 1980.3	4839.3 90.0	1668.9 375.1	2002.6 450.1	171.5 35.1	184.3 37.7	197.0 40.4	3.46 11.36	3.46 11.36
JDF 44 ODx0.625/PZC13	PZC13	MF63	2597 102.23	1931.4 117.9	332438.4 2434.4	5949.2 110.7	2051.6 461.1	2461.9 553.3	204.3 41.9	217.1 44.5	229.9 47.1	3.46 11.36	3.46 11.36
JDF 44 ODx0.750/PZC13	PZC13	MF63	2597 102.23	2205.7 134.6	393376.2 2880.6	7039.7 130.9	2427.7 545.6	2913.2 654.7	237.0 48.5	249.7 51.2	262.5 53.8	3.46 11.36	3.46 11.36
JDF 48 ODx0.500/PZC13	PZC13	MF63	2698 106.23	1758.5 107.3	335537.3 2457.1	5504.2 102.4	1898.2 426.6	2277.8 511.9	176.8 36.2	189.1 38.7	201.4 41.2	3.62 11.88	3.62 11.88
JDF 48 ODx0.625/PZC13	PZC13	MF63	2698 106.23	2060.1 125.7	413529.0 3028.2	6783.6 126.2	2339.4 525.7	2807.2 630.9	211.4 43.3	223.7 45.8	235.9 48.3	3.62 11.88	3.62 11.88
JDF 48 ODx0.750/PZC13	PZC13	MF63	2698 106.23	2360.1 144.0	490279.5 3590.3	8042.6 149.6	2773.5 623.3	3328.2 748.0	245.8 50.3	258.0 52.8	270.3 55.4	3.62 11.88	3.62 11.88
JDF 52 ODx0.625/PZC13	PZC13	MF63	2800 110.23	2188.8 133.6	505328.8 3700.5	7651.9 142.3	2638.8 593.0	3166.5 711.6	217.9 44.6	229.8 47.1	241.6 49.5	3.78 12.41	3.78 12.41
JDF 52 ODx0.750/PZC13	PZC13	MF63	2800 110.23	2514.6 153.5	600010.6 4393.8	9085.6 169.0	3133.2 704.1	3759.8 845.0	253.9 52.0	265.7 54.4	277.5 56.8	3.78 12.41	3.78 12.41
JDF 52 ODx0.875/PZC13	PZC13	MF63	2800 110.23	2838.8 173.2	693296.6 5076.9	10498.1 195.3	3620.3 813.6	4344.4 976.3	289.7 59.3	301.5 61.8	313.3 64.2	3.78 12.41	3.78 12.41
JDF 56 ODx0.750/PZC13	PZC13	MF63	2901 114.23	2669.0 162.9	722844.4 5293.3	10163.7 189.0	3505.0 787.7	4206.0 945.2	261.4 53.5	272.9 55.9	284.3 58.2	3.94 12.93	3.94 12.93
JDF 56 ODx0.875/PZC13	PZC13	MF63	2901 114.23	3018.9 184.2	836055.3 6122.3	11755.6 218.7	4054.0 911.1	4864.7 1093.3	298.7 61.2	310.1 63.5	321.5 65.9	3.94 12.93	3.94 12.93
JDF 56 ODx1.00/PZC13	PZC13	MF63	2901 114.23	3367.2 205.5	947711.9 6940.0	13325.5 247.9	4595.4 1032.7	5514.4 1239.3	335.8 68.8	347.2 71.1	358.6 73.5	3.94 12.93	3.94 12.93
JDF 60 ODx0.750/PZC13	PZC13	MF63	3003 118.23	2823.5 172.3	859018.5 6290.5	11273.2 209.7	3887.6 873.7	4665.1 1048.4	268.5 55.0	279.5 57.3	290.5 59.5	4.10 13.45	4.10 13.45
JDF 60 ODx0.875/PZC13	PZC13	MF63	3003 118.23	3199.1 195.2	994357.7 7281.6	13049.3 242.7	4500.1 1011.3	5400.1 1213.6	307.1 62.9	318.2 65.2	329.2 67.4	4.10 13.45	4.10 13.45
JDF 60 ODx1.00/PZC13	PZC13	MF63	3003 118.23	3573.2 218.0	1127965.5 8260.0	14802.7 275.3	5104.8 1147.2	6125.7 1376.7	345.6 70.8	356.7 73.1	367.7 75.3	4.10 13.45	4.10 13.45
JDF 64 ODx0.750/PZC13	PZC13	MF63	3105 122.23	2977.9 181.7	1008739.6 7386.9	12410.7 230.8	4279.9 961.8	5135.8 1154.2	275.1 56.3	285.7 58.5	296.4 60.7	4.26 13.98	4.26 13.98
JDF 64 ODx0.875/PZC13	PZC13	MF63	3105 122.23	3379.3 206.2	1168446.7 8556.4	14375.6 267.4	4957.5 1114.1	5949.0 1336.9	315.0 64.5	325.7 66.7	336.4 68.9	4.26 13.98	4.26 13.98
JDF 64 ODx1.00/PZC13	PZC13	MF63	3105 122.23	3779.1 230.6	1326241.1 9711.9	16317.0 303.5	5627.0 1264.6	6752.4 1517.5	354.8 72.7	365.5 74.9	376.2 77.0	4.26 13.98	4.26 13.98
JDF 68 ODx0.750/PZC13	PZC13	MF63	3206 126.23	3132.4 191.1	1172188.0 8583.8	13573.3 252.5	4680.8 1051.9	5617.0 1262.3	281.2 57.6	291.6 59.7	301.9 61.8	4.42 14.50	4.42 14.50
JDF 68 ODx0.875/PZC13	PZC13	MF63	3206 126.23	3559.5 217.2	1358534.5 9948.4	15731.1 292.6	5424.9 1219.2	6509.9 1463.0	322.4 66.0	332.7 68.2	343.1 70.3	4.42 14.50	4.42 14.50
JDF 68 ODx1.00/PZC13	PZC13	MF63	3206 126.23	3985.0 243.2	1542783.2 11297.6	17864.6 332.3	6160.7 1384.5	7392.8 1661.4	363.4 74.4	373.8 76.6	384.1 78.7	4.42 14.50	4.42 14.50
JDF 72 ODx0.750/PZC13	PZC13	MF63	3308 130.23	3286.8 200.6	1349521.9 9882.4	14758.6 274.5	5089.5 1143.8	6107.5 1372.6	287.0 58.8	297.0 60.8	307.1 62.9	4.58 15.02	4.58 15.02
JDF 72 ODx0.875/PZC13	PZC13	MF63	3308 130.23	3739.7 228.2	1564807.1 11458.9	17112.9 318.3	5901.5 1326.3	7081.8 1591.5	329.3 67.5	339.4 69.5	349.4 71.6	4.58 15.02	4.58 15.02
JDF 72 ODx1.00/PZC13	PZC13	MF63	3308 130.23	4190.9 255.7	1777806.1 13018.7	19442.3 361.6	6704.8 1506.8	8045.7 1808.1	371.5 76.1	381.5 78.1	391.5 80.2	4.58 15.02	4.58 15.02

* Larger, custom pipe sizes and wall thicknesses are available upon request. Please contact us at eng@jdfields.com for availability.

PIPE PZC COMBI-WALL SYSTEM

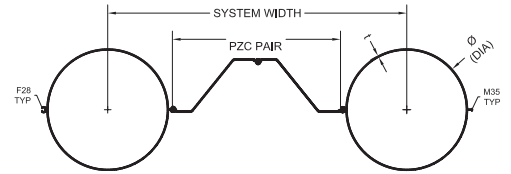

PIPE PZC18	Sheet Pile Section	Pipe-Sheet Connector	System Width	Per Unit of Wall				50 ksi	60 ksi	Mass: Beam/Sheet Ratio			Coating Area	
				Cross Sectional Area (A)	Combined Moment of Inertia (Iy)	Combined Elastic Modulus (Sx)	Ultimate Bend. Moment (Mmax)	PIPE / PZC 60% (m) ²	PIPE / PZC 80% (m) ²	PIPE / PZC 100% (m) ²	Waterside Surface (A')	Landside Surface (A'')		
				mm	cm ²	cm ⁴ /m	cm ³ /m	kN-m/m	kg/m ²	kg/m ²	kg/m ²	m ² /m	m ² /m	
			in	in ²	in ⁴ /ft	in ³ /ft	kip-ft/ft	lbs/ft ²	lbs/ft ²	lbs/ft ²	ft ² /ft	ft ² /ft		
JDF 30 ODx0.500/PZC18	PZC18	MF63	2095 82.48	1295.2 79.0	121326.9 888.5	3184.4 59.2	1098.2 246.8	1317.8 296.2	159.4 32.7	175.2 35.9	191.0 39.1	2.90 9.53	2.90 9.53	
JDF 30 ODx0.625/PZC18	PZC18	MF63	2095 82.48	1481.0 90.4	144806.7 1060.4	3800.7 70.7	1310.7 294.6	1572.8 353.5	186.8 38.3	202.6 41.5	218.4 44.7	2.90 9.53	2.90 9.53	
JDF 30 ODx0.750/PZC18	PZC18	MF63	2095 82.48	1665.2 101.6	167681.9 1227.9	4401.1 81.9	1517.7 341.1	1821.3 409.3	214.0 43.8	229.8 47.1	245.6 50.3	2.90 9.53	2.90 9.53	
JDF 36 ODx0.500/PZC18	PZC18	MF63	2247 88.48	1449.6 88.5	182440.2 1336.0	3990.4 74.2	1376.1 309.3	1651.3 371.1	169.9 34.8	184.6 37.8	199.3 40.8	3.14 10.31	3.14 10.31	
JDF 36 ODx0.625/PZC18	PZC18	MF63	2247 88.48	1674.0 102.2	221003.3 1618.4	4833.8 89.9	1667.0 374.6	2000.4 449.6	200.7 44.1	215.4 44.1	230.2 47.1	3.14 10.31	3.14 10.31	
JDF 36 ODx0.750/PZC18	PZC18	MF63	2247 88.48	1896.8 115.8	258743.0 1894.7	5659.3 105.3	1951.6 438.6	2342.0 526.3	231.4 47.4	246.1 50.4	260.8 53.4	3.14 10.31	3.14 10.31	
JDF 40 ODx0.500/PZC18	PZC18	MF63	2349 92.48	1552.6 94.7	233320.0 1708.6	4592.9 85.4	1583.9 356.0	1900.7 427.1	176.1 36.1	190.2 38.9	204.2 41.8	3.30 10.84	3.30 10.84	
JDF 40 ODx0.625/PZC18	PZC18	MF63	2349 92.48	1802.7 110.0	284421.9 2082.8	5598.9 104.1	1930.8 433.9	2316.9 520.7	209.0 42.8	223.1 45.7	237.2 48.6	3.30 10.84	3.30 10.84	
JDF 40 ODx0.750/PZC18	PZC18	MF63	2349 92.48	2051.3 125.2	334544.1 2449.8	6585.5 122.5	2271.0 510.4	2725.3 612.5	241.7 49.5	255.8 52.4	269.9 55.3	3.30 10.84	3.30 10.84	
JDF 44 ODx0.500/PZC18	PZC18	MF63	2451 96.48	1655.5 101.0	292627.2 2142.9	5236.7 97.4	1805.9 405.8	2167.1 487.0	181.7 37.2	195.3 40.0	208.8 42.8	3.46 11.36	3.46 11.36	
JDF 44 ODx0.625/PZC18	PZC18	MF63	2451 96.48	1931.4 117.9	358339.6 2624.1	6412.7 119.3	2211.4 497.0	2653.7 596.4	216.5 44.3	230.0 47.1	243.6 49.9	3.46 11.36	3.46 11.36	
JDF 44 ODx0.750/PZC18	PZC18	MF63	2451 96.48	2205.7 134.6	422909.2 3096.9	7568.2 140.8	2609.9 586.5	3131.9 703.8	251.1 51.4	264.6 54.2	278.1 57.0	3.46 11.36	3.46 11.36	
JDF 48 ODx0.500/PZC18	PZC18	MF63	2552 100.48	1758.5 107.3	360584.8 2640.5	5915.1 110.0	2039.8 458.4	2447.8 550.1	187.0 38.3	199.9 41.0	212.9 43.6	3.62 11.88	3.62 11.88	
JDF 48 ODx0.625/PZC18	PZC18	MF63	2552 100.48	2060.1 125.7	443039.5 3244.3	7267.7 135.2	2506.3 563.3	3007.6 675.9	223.5 45.8	236.5 48.4	249.4 51.1	3.62 11.88	3.62 11.88	
JDF 48 ODx0.750/PZC18	PZC18	MF63	2552 100.48	2360.2 144.0	524182.1 3838.5	8598.8 159.9	2965.3 666.4	3558.4 799.7	259.8 53.2	272.8 55.9	285.8 58.5	3.62 11.88	3.62 11.88	
JDF 52 ODx0.625/PZC18	PZC18	MF63	2654 104.48	2188.8 133.6	538761.7 3945.3	8158.1 151.7	2813.4 632.3	3376.0 758.7	229.9 47.1	242.4 49.6	254.9 52.2	3.78 12.41	3.78 12.41	
JDF 52 ODx0.750/PZC18	PZC18	MF63	2654 104.48	2514.6 153.5	638654.2 4676.8	9670.7 179.9	3335.0 749.5	4002.0 899.4	267.9 54.9	280.3 57.4	292.8 60.0	3.78 12.41	3.78 12.41	
JDF 52 ODx0.875/PZC18	PZC18	MF63	2654 104.48	2838.8 173.2	737074.2 5397.5	11161.0 207.6	3848.9 865.0	4618.7 1038.0	305.6 62.6	318.1 65.1	330.6 67.7	3.78 12.41	3.78 12.41	
JDF 56 ODx0.750/PZC18	PZC18	MF63	2755 108.48	2669.1 162.9	766573.9 5613.5	10778.6 200.5	3717.0 835.3	4460.5 1002.4	275.3 56.4	287.3 58.8	299.3 61.3	3.94 12.93	3.94 12.93	
JDF 56 ODx0.875/PZC18	PZC18	MF63	2755 108.48	3019.0 184.2	885785.7 6486.5	12454.8 231.7	4295.1 965.3	5154.1 1158.3	314.5 64.4	326.6 66.9	338.6 69.3	3.94 12.93	3.94 12.93	
JDF 56 ODx1.00/PZC18	PZC18	MF63	2755 108.48	3367.3 205.5	1003360.6 7347.5	14108.0 262.4	4865.2 1093.4	5838.2 1312.1	353.6 72.4	365.6 74.9	377.6 77.3	3.94 12.93	3.94 12.93	
JDF 60 ODx0.750/PZC18	PZC18	MF63	2857 112.48	2823.5 172.3	908154.2 6650.3	11918.0 221.7	4110.0 923.7	4932.0 1108.4	282.2 57.8	293.8 62.6	305.4 62.6	4.10 13.45	4.10 13.45	
JDF 60 ODx0.875/PZC18	PZC18	MF63	2857 112.48	3199.2 195.2	1050412.0 7692.0	13784.9 256.4	4753.8 1068.3	5704.5 1282.0	322.8 66.1	334.4 68.5	346.0 70.9	4.10 13.45	4.10 13.45	
JDF 60 ODx1.00/PZC18	PZC18	MF63	2857 112.48	3573.2 218.1	1190849.8 8720.5	15628.0 290.7	5389.4 1211.2	6467.2 1453.4	363.3 74.4	374.9 76.8	386.5 79.2	4.10 13.45	4.10 13.45	
JDF 64 ODx0.75/PZC18	PZC18	MF63	2959 116.48	2977.9 181.7	1063578.9 7788.5	13085.4 243.4	4512.5 1014.1	5415.1 1216.9	288.7 59.1	299.9 61.4	311.0 63.7	4.26 13.98	4.26 13.98	
JDF 64 ODx0.875/PZC18	PZC18	MF63	2959 116.48	3379.3 206.2	1231169.9 9015.7	15147.3 281.7	5223.6 1173.9	6268.3 1408.7	330.6 67.7	341.8 70.0	353.0 72.3	4.26 13.98	4.26 13.98	
JDF 64 ODx1.00/PZC18	PZC18	MF63	2959 116.48	3779.1 230.6	1396753.8 10228.3	17184.5 319.6	5926.1 1331.8	7111.4 1598.2	372.3 76.3	383.5 78.6	394.7 80.8	4.26 13.98	4.26 13.98	
JDF 68 ODx0.750/PZC18	PZC18	MF63	3060 120.48	3132.4 191.2	1233007.3 9029.2	14277.5 265.6	4923.7 1106.5	5908.4 1327.8	294.7 60.4	305.5 62.6	316.3 64.8	4.42 14.50	4.42 14.50	
JDF 68 ODx0.875/PZC18	PZC18	MF63	3060 120.48	3559.5 217.2	1428247.3 10458.9	16538.3 307.6	5703.3 1281.7	6844.0 1538.1	337.8 69.2	348.6 71.4	359.4 73.6	4.42 14.50	4.42 14.50	
JDF 68 ODx1.00/PZC18	PZC18	MF63	3060 120.48	3985.0 243.2	1621289.4 11872.5	18773.6 349.2	6474.2 1455.0	7769.0 1746.0	380.8 78.0	391.6 80.2	402.4 82.4	4.42 14.50	4.42 14.50	
JDF 72 ODx0.750/PZC18	PZC18	MF63	3162 124.48	3286.8 200.6	1416578.3 10373.4	15491.9 288.2	5342.4 1200.6	6410.9 1440.8	300.3 61.5	310.8 63.7	321.2 65.8	4.58 15.02	4.58 15.02	
JDF 72 ODx0.875/PZC18	PZC18	MF63	3162 124.48	3739.7 228.2	1641808.0 12022.8	17955.0 334.0	6191.9 1391.5	7430.2 1669.8	344.6 70.6	355.0 72.7	365.5 74.9	4.58 15.02	4.58 15.02	
JDF 72 ODx1.00/PZC18	PZC18	MF63	3162 124.48	4191.0 255.7	1864645.8 13654.6	20392.0 379.3	7032.3 1580.4	8438.7 1896.5	388.7 79.6	399.1 81.7	409.6 83.9	4.58 15.02	4.58 15.02	

* Larger, custom pipe sizes and wall thicknesses are available upon request. Please contact us at eng@jdfields.com for availability.

PIPE PZC COMBI-WALL SYSTEM

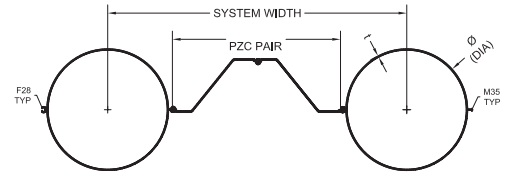

PIPE PZC26	Sheet Pile Section	Pipe-Sheet Connector	System Width	Per Unit of Wall			50 ksi	60 ksi	Mass: Beam/Sheet Ratio			Coating Area	
				Cross Sectional Area (A)	Combined Moment of Inertia (Iy)	Combined Elastic Modulus (Sx)	Ultimate Bend. Moment (Mmax)	PIPE / PZC 60% (m)''	PIPE / PZC 80% (m)''	PIPE / PZC 100% (m)''	Waterside Surface (A')	Landside Surface (A'')	
				mm	cm ²	cm ⁴ /m	cm ³ /m	kN-m/m	kg/m ²	kg/m ²	kg/m ²	m ² /m	m ² /m
JDF 30 ODx0.500/PZC26	PZC26	MF63	2238 88.11	1521.3 92.8	130762.3 957.6	3432.1 63.8	1183.6 266.0	1420.3 319.2	168.0 34.4	189.0 38.7	210.1 43.0	3.07 10.08	3.07 10.08
JDF 30 ODx0.625/PZC26	PZC26	MF63	2238 88.11	1707.1 104.2	152741.8 1118.5	4009.0 74.6	1382.5 310.7	1659.0 372.8	193.6 39.7	214.7 44.0	235.7 48.3	3.07 10.08	3.07 10.08
JDF 30 ODx0.750/PZC26	PZC26	MF63	2238 88.11	1891.3 115.4	174155.3 1275.3	4571.0 85.0	1576.3 354.3	1891.6 425.1	219.1 44.9	240.1 49.2	261.2 53.5	3.07 10.08	3.07 10.08
JDF 36 ODx0.500/PZC26	PZC26	MF63	2390 94.11	1675.7 102.3	187618.0 1373.9	4103.6 76.3	1415.2 318.0	1698.2 381.6	177.2 36.3	196.9 40.3	216.6 44.4	3.31 10.86	3.31 10.86
JDF 36 ODx0.625/PZC26	PZC26	MF63	2390 94.11	1900.1 116.0	223874.1 1639.4	4896.6 91.1	1688.6 379.5	2026.3 455.4	206.2 42.2	225.9 46.3	245.6 50.3	3.31 10.86	3.31 10.86
JDF 36 ODx0.750/PZC26	PZC26	MF63	2390 94.11	2123.0 129.6	259356.1 1899.2	5672.7 105.5	1956.3 439.6	2347.5 527.6	235.1 48.1	254.8 52.2	274.5 56.2	3.31 10.86	3.31 10.86
JDF 40 ODx0.500/PZC26	PZC26	MF63	2492 98.11	1778.7 108.5	235367.0 1723.6	4633.2 86.2	1597.8 359.1	1917.3 430.9	182.8 37.4	201.7 41.3	220.6 45.2	3.47 11.39	3.47 11.39
JDF 40 ODx0.625/PZC26	PZC26	MF63	2492 98.11	2028.9 123.8	283536.4 2076.3	5581.4 103.8	1924.8 432.6	2309.7 519.1	213.8 43.8	232.7 47.7	251.6 51.5	3.47 11.39	3.47 11.39
JDF 40 ODx0.750/PZC26	PZC26	MF63	2492 98.11	2277.4 139.0	330782.4 2422.3	6511.5 121.1	2245.5 504.6	2694.6 605.6	244.6 50.1	263.5 54.0	282.4 57.8	3.47 11.39	3.47 11.39
JDF 44 ODx0.500/PZC26	PZC26	MF63	2594 102.11	1881.6 114.8	291324.0 2133.3	5213.4 97.0	1797.9 404.0	2157.4 484.8	187.9 38.5	206.0 42.2	224.2 45.9	3.63 11.91	3.63 11.91
JDF 44 ODx0.625/PZC26	PZC26	MF63	2594 102.11	2157.6 131.7	353413.2 2588.0	6324.5 117.6	2181.0 490.2	2617.2 588.2	220.8 45.2	238.9 48.9	257.1 52.7	3.63 11.91	3.63 11.91
JDF 44 ODx0.750/PZC26	PZC26	MF63	2594 102.11	2431.9 148.4	414422.7 3034.8	7416.3 137.9	2557.5 574.8	3069.0 689.7	253.4 51.9	271.6 55.6	289.8 59.3	3.63 11.91	3.63 11.91
JDF 48 ODx0.500/PZC26	PZC26	MF63	2695 106.11	1984.6 121.1	355725.0 2604.9	5835.4 108.5	2012.4 452.2	2414.8 542.7	192.6 39.4	210.1 43.0	227.6 46.6	3.79 12.43	3.79 12.43
JDF 48 ODx0.625/PZC26	PZC26	MF63	2695 106.11	2286.3 139.5	433804.9 3176.7	7116.2 132.4	2454.1 551.5	2944.9 661.8	227.2 46.5	244.7 50.1	262.1 53.7	3.79 12.43	3.79 12.43
JDF 48 ODx0.750/PZC26	PZC26	MF63	2695 106.11	2586.3 157.8	510642.1 3739.4	8376.7 155.8	2888.7 649.2	3466.5 779.0	261.6 53.6	279.1 57.2	296.5 60.7	3.79 12.43	3.79 12.43
JDF 52 ODx0.625/PZC26	PZC26	MF63	2797 110.11	2415.0 147.4	524968.1 3844.3	7949.2 147.9	2741.3 616.1	3289.6 739.3	233.2 47.8	250.0 51.2	266.8 54.7	3.95 12.96	3.95 12.96
JDF 52 ODx0.750/PZC26	PZC26	MF63	2797 110.11	2740.7 167.3	619753.1 4538.4	9384.5 174.6	3236.3 727.3	3883.5 872.8	269.2 55.1	286.0 58.6	302.8 62.0	3.95 12.96	3.95 12.96
JDF 52 ODx0.875/PZC26	PZC26	MF63	2797 110.11	3064.9 187.0	713140.8 5222.2	10798.6 200.9	3723.9 836.9	4468.7 1004.3	305.0 62.5	321.8 65.9	338.6 69.4	3.95 12.96	3.95 12.96
JDF 56 ODx0.750/PZC26	PZC26	MF63	2898 114.11	2895.2 176.7	742024.0 5433.8	10433.4 194.1	3598.0 808.6	4317.6 970.3	276.2 56.6	292.4 59.9	308.7 63.2	4.11 13.48	4.11 13.48
JDF 56 ODx0.875/PZC26	PZC26	MF63	2898 114.11	3245.1 198.0	855354.0 6263.7	12026.9 223.7	4147.5 932.1	4977.0 1118.5	313.5 64.2	329.7 67.5	346.0 70.9	4.11 13.48	4.11 13.48
JDF 56 ODx1.00/PZC26	PZC26	MF63	2898 114.11	3593.4 219.3	967128.1 7082.2	13598.5 252.9	4689.5 1053.9	5627.4 1264.7	350.6 71.8	366.9 75.1	383.1 78.5	4.11 13.48	4.11 13.48
JDF 60 ODx0.750/PZC26	PZC26	MF63	3000 118.11	3049.6 186.1	877687.0 6427.2	11518.2 214.2	3972.1 892.7	4766.5 1071.2	282.7 57.9	298.4 61.1	314.1 64.3	4.27 14.00	4.27 14.00
JDF 60 ODx0.875/PZC26	PZC26	MF63	3000 118.11	3425.3 209.0	1013163.7 7419.3	13296.1 247.3	4585.2 1030.5	5502.3 1236.5	321.4 65.8	337.1 69.1	352.8 72.3	4.27 14.00	4.27 14.00
JDF 60 ODx1.00/PZC26	PZC26	MF63	3000 118.11	3799.3 231.8	1146907.2 8398.7	15051.3 280.0	5190.5 1166.5	6228.6 1399.8	360.0 73.7	375.7 76.9	391.4 80.2	4.27 14.00	4.27 14.00
JDF 64 ODx0.750/PZC26	PZC26	MF63	3102 122.11	3204.1 195.5	1026943.7 7520.2	12634.6 235.0	4357.1 979.2	5228.5 1175.0	288.9 59.2	304.0 62.3	319.2 65.4	4.43 14.53	4.43 14.53
JDF 64 ODx0.875/PZC26	PZC26	MF63	3102 122.11	3605.5 220.0	1186807.7 8690.9	14601.5 271.6	5035.4 1131.6	6042.5 1357.9	328.9 67.4	344.0 70.5	359.2 73.6	4.43 14.53	4.43 14.53
JDF 64 ODx1.00/PZC26	PZC26	MF63	3102 122.11	4005.2 244.4	1344757.2 9847.5	16544.8 307.7	5705.5 1282.2	6846.6 1538.7	368.7 75.5	383.9 78.6	399.1 81.7	4.43 14.53	4.43 14.53
JDF 68 ODx0.750/PZC26	PZC26	MF63	3203 126.11	3358.5 204.9	1189970.2 8714.0	13779.2 256.3	4751.8 1067.9	5702.2 1281.5	294.6 60.3	309.3 63.4	324.0 66.4	4.59 15.05	4.59 15.05
JDF 68 ODx0.875/PZC26	PZC26	MF63	3203 126.11	3785.6 231.0	1376494.0 10079.9	15939.0 296.5	5496.6 1235.3	6596.0 1482.3	335.8 68.8	350.5 71.8	365.2 74.8	4.59 15.05	4.59 15.05
JDF 68 ODx1.00/PZC26	PZC26	MF63	3203 126.11	4211.2 257.0	1560918.0 11430.4	18074.6 336.2	6233.1 1400.8	7479.7 1680.9	376.9 77.2	391.6 80.2	406.3 83.2	4.59 15.05	4.59 15.05
JDF 72 ODx0.750/PZC26	PZC26	MF63	3305 130.11	3513.0 214.4	1366921.0 10009.8	14948.8 278.1	5155.2 1158.5	6186.2 1390.3	300.0 61.4	314.2 64.4	328.5 67.3	4.75 15.57	4.75 15.57
JDF 72 ODx0.875/PZC26	PZC26	MF63	3305 130.11	3965.8 242.0	1582404.7 11587.8	17305.4 321.9	5967.8 1341.2	7161.4 1609.4	342.3 70.1	356.6 73.0	370.8 76.0	4.75 15.57	4.75 15.57
JDF 72 ODx1.00/PZC26	PZC26	MF63	3305 130.11	4417.1 269.5	1795600.1 13149.0	19636.9 365.2	6771.9 1521.9	8126.2 1826.2	384.5 78.8	398.8 81.7	413.0 84.6	4.75 15.57	4.75 15.57

* Larger, custom pipe sizes and wall thicknesses are available upon request. Please contact us at eng@jdfields.com for availability.

HZ®-M STEEL WALL SYSTEMS

Combination HZ...M-12 / AZ 18-800

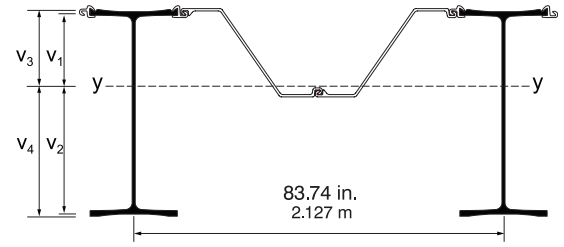

SECTION	PROPERTIES PER FOOT OF WALL				MASS OF COMBINATION WITH INTERMEDIARY SECTION				
	Sectional Area in ² /ft cm ² /m	Moment of Inertia in ⁴ /ft cm ⁴ /m	*Elastic Section Modulus in ³ /ft cm ³ /m	**Elastic Section Modulus in ³ /ft cm ³ /m	*** AZ 18-800			COATING AREA	
					EAZ = 60% EHZ lb/ft ² kg/m ²	EAZ = 80% EHZ lb/ft ² kg/m ²	EAZ = EHZ lb/ft ² kg/m ²	Waterside ft ² /ft m ² /m	Landside ft ² /ft m ² /m
HZ 630M	12.55 265.7	1,112.0 151,850	83.0 4,465	93.0 5,000	35.13 172	38.93 190	42.72 209	8.73 2.660	15.11 4.605
HZ 880M A	11.97 253.4	1,641.1 224,100	93.2 5,010	106.7 5,740	33.28 162	37.01 181	40.74 199	8.85 2.699	16.72 5.095
HZ 880M B	12.68 268.3	1,763.9 240,880	100.7 5,415	113.5 6,100	35.69 174	39.42 192	43.14 211	8.86 2.702	16.72 5.097
HZ 880M C	13.00 275.1	1,847.3 252,260	105.4 5,665	118.4 6,365	36.78 180	40.51 198	44.23 216	8.86 2.702	16.72 5.097
HZ 1080M A	13.69 289.8	2,964.2 404,780	131.7 7,080	147.7 7,940	39.12 191	42.86 209	46.59 227	8.84 2.695	18.15 5.533
HZ 1080M B	14.20 300.6	3,188.2 435,370	141.6 7,615	157.9 8,490	40.86 200	44.60 218	48.33 236	8.84 2.696	18.15 5.533
HZ 1080M C	15.12 320.1	3,458.0 472,210	153.9 8,270	169.9 9,135	44.00 215	47.73 233	51.47 251	8.85 2.697	18.16 5.535
HZ 1080M D	15.87 335.9	3,721.3 508,160	165.2 8,880	181.9 9,780	46.55 227	50.28 245	54.01 264	8.85 2.698	18.16 5.535
HZ 1180M A	16.47 348.6	3,919.2 535,180	173.4 9,320	190.9 10,260	48.58 237	52.31 255	56.04 274	8.85 2.699	18.16 5.536
HZ 1180M B	16.85 356.6	4,092.7 558,890	181.1 9,735	198.5 10,675	49.88 244	53.61 262	57.34 280	8.86 2.700	18.18 5.540
HZ 1180M C	17.59 372.3	4,347.6 593,690	191.0 10,270	210.5 11,315	52.26 255	56.06 274	59.85 292	8.90 2.713	18.20 5.549
HZ 1180M D	18.17 384.7	4,548.1 621,070	200.5 10,780	218.6 11,750	54.26 265	58.05 283	61.85 302	8.92 2.719	18.22 5.554

* Referring outside of HZ®-M-flange (v₂), ** Referring outside of connector (v₃), *** Length of connectors = Length of AZ.

HZ®-M STEEL WALL SYSTEMS

Combination HZ...M-14 / AZ 18-800

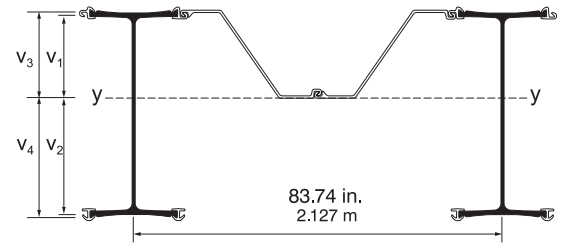

SECTION	PROPERTIES PER FOOT OF WALL				MASS OF COMBINATION WITH INTERMEDIARY SECTION				
	Sectional Area in ² /ft cm ² /m	Moment of Inertia in ⁴ /ft cm ⁴ /m	*Elastic Section Modulus in ³ /ft cm ³ /m	**Elastic Section Modulus in ³ /ft cm ³ /m	*** AZ 26-700			COATING AREA	
					EAZ = 60% EHZ lb/ft ² kg/m ²	EAZ = 80% EHZ lb/ft ² kg/m ²	EAZ = EHZ lb/ft ² kg/m ²	Waterside ft ² /ft m ² /m	Landside ft ² /ft m ² /m
HZ 630M	13.39 283.3	1,243.7 169,840	102.5 5,510	93.9 5,045	36.72 179	41.14 201	45.55 222	8.73 2.660	16.03 4.886
HZ 880M A	12.79 270.8	1,872.7 255,730	118.2 6,355	108.9 5,855	34.87 170	39.20 191	43.54 213	8.85 2.699	17.49 5.331
HZ 880M B	13.49 285.6	1,991.2 271,910	125.1 6,725	115.8 6,225	37.25 182	41.58 203	45.92 224	8.86 2.702	17.50 5.334
HZ 880M C	13.81 292.4	2,073.7 283,180	129.6 6,970	120.6 6,485	38.34 187	42.68 208	47.01 230	8.86 2.702	17.50 5.334
HZ 1080M A	14.52 307.3	3,350.9 457,580	162.3 8,725	152.3 8,185	40.71 199	45.06 220	49.40 241	8.84 2.695	18.92 5.768
HZ 1080M B	15.02 317.9	3,569.0 487,370	171.9 9,240	162.2 8,720	42.43 207	46.77 228	51.12 250	8.84 2.696	18.93 5.769
HZ 1080M C	15.94 337.4	3,835.7 523,790	183.7 9,875	174.3 9,375	45.56 222	49.91 244	54.25 265	8.85 2.697	18.93 5.771
HZ 1080M D	16.69 353.2	4,097.0 559,460	194.7 10,470	186.2 10,015	48.11 235	52.45 256	56.79 277	8.85 2.698	18.94 5.771
HZ 1180M A	17.28 365.8	4,293.0 586,240	202.6 10,890	195.4 10,505	50.14 245	54.48 266	58.82 287	8.85 2.699	18.94 5.772
HZ 1180M B	17.64 373.4	4,452.9 608,070	209.3 11,255	202.4 10,885	51.35 251	55.69 272	60.03 293	8.86 2.700	18.94 5.774
HZ 1180M C	18.60 393.8	4,806.3 656,330	223.6 12,020	216.0 11,610	54.20 265	58.76 287	63.31 309	8.90 2.713	19.05 5.808
HZ 1180M D	19.14 405.1	4,978.1 679,780	230.8 12,410	223.8 12,030	56.02 273	60.57 296	65.13 318	8.92 2.719	19.07 5.814

* Referring outside of HZ®-M-flange (highest value of v₁; v₂), ** Referring outside of connector (highest value of v₃; v₄), *** Length of connectors = Length of AZ.

HZ[®]-M STEEL WALL SYSTEMS

Combination HZ...M-24 / AZ 18-800

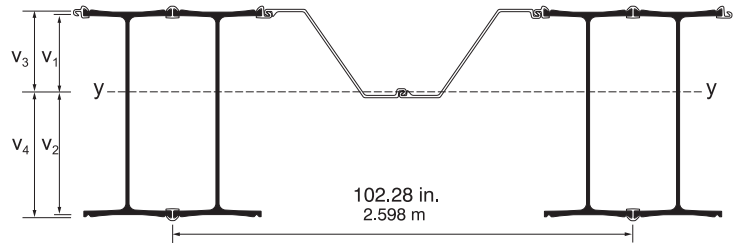

<small>JD</small> FIELDS <small>& COMPANY, INC.</small> <small>A FIELD COMPANY</small>	PROPERTIES PER FOOT OF WALL				MASS OF COMBINATION WITH INTERMEDIARY SECTION				
	Sectional Area in ² /ft cm ² /m	Moment of Inertia in ⁴ /ft cm ⁴ /m	*Elastic Section Modulus in ³ /ft cm ³ /m	**Elastic Section Modulus in ³ /ft cm ³ /m	*** AZ 18-800			COATING AREA	
					£AZ = 60% £HZ lb/ft ² kg/m ²	£AZ = 80% £HZ lb/ft ² kg/m ²	£AZ = £HZ lb/ft ² kg/m ²	Waterside ft ² /ft m ² /m	Landside ft ² /ft m ² /m
SECTION									
HZ 630M	16.79 355.5	1,644.7 224,600	128.2 6,895	118.0 6,345	50.87 248	54.01 264	57.15 279	10.32 3.145	16.76 5.109
HZ 880M A	15.73 332.9	2,495.8 340,810	148.6 7,985	137.5 7,390	47.42 232	50.47 246	53.52 261	10.57 3.222	18.49 5.637
HZ 880M B	16.87 357.0	2,689.6 367,290	160.2 8,610	148.9 8,005	51.30 250	54.35 265	57.40 280	10.59 3.229	18.51 5.643
HZ 880M C	17.39 368.1	2,825.1 385,790	167.8 9,020	156.7 8,420	53.09 259	56.14 274	59.18 289	10.59 3.228	18.51 5.643
HZ 1080M A	18.56 392.8	4,656.0 635,800	215.0 11,555	202.3 10,875	57.04 278	60.10 293	63.16 308	10.54 3.214	19.92 6.070
HZ 1080M B	19.39 410.3	5,014.3 684,730	230.8 12,410	218.4 11,740	59.85 292	62.91 307	65.97 322	10.55 3.216	19.92 6.073
HZ 1080M C	20.88 442.1	5,450.3 744,280	250.5 13,470	238.3 12,810	64.96 317	68.02 332	71.07 347	10.56 3.219	19.93 6.076
HZ 1080M D	22.11 467.9	5,877.7 802,640	269.0 14,460	257.7 13,855	69.12 337	72.17 352	75.23 367	10.57 3.220	19.94 6.077
HZ 1180M A	23.08 488.4	6,198.0 846,370	282.2 15,170	272.2 14,635	72.43 354	75.48 369	78.53 383	10.57 3.222	19.94 6.079
HZ 1180M B	23.66 500.8	6,460.1 882,170	293.4 15,770	284.0 15,270	74.41 363	77.46 378	80.51 393	10.58 3.225	19.97 6.088
HZ 1180M C	24.95 528.0	6,919.2 944,860	312.7 16,810	302.3 16,255	78.69 384	81.79 399	84.90 415	10.64 3.242	20.02 6.101
HZ 1180M D	25.81 546.4	7,198.9 983,050	324.6 17,455	315.0 16,935	81.64 399	84.74 414	87.84 429	10.68 3.254	20.05 6.110

* Referring outside of HZ[®]-M-flange (v₂), ** Referring outside of connector (v₃), *** Length of connectors = Length of AZ.

HZ[®]-M STEEL WALL SYSTEMS

Combination HZ...M-26 / AZ 18-800

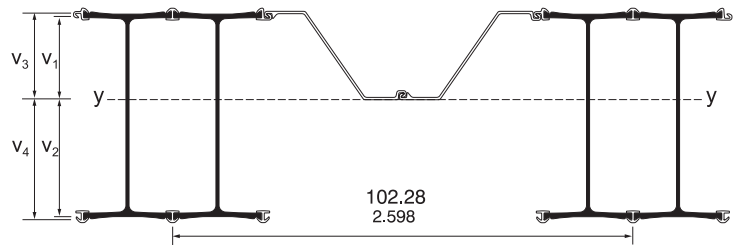

<small>JD</small> FIELDS <small>& COMPANY, INC.</small> <small>A FIELDS COMPANY</small>	PROPERTIES PER FOOT OF WALL				MASS OF COMBINATION WITH INTERMEDIARY SECTION				
	Sectional Area in ² /ft cm ² /m	Moment of Inertia in ⁴ /ft cm ⁴ /m	*Elastic Section Modulus in ³ /ft cm ³ /m	**Elastic Section Modulus in ³ /ft cm ³ /m	*** AZ 18-800			COATING AREA	
					£AZ = 60% £HZ lb/ft ² kg/m ²	£AZ = 80% £HZ lb/ft ² kg/m ²	£AZ = £HZ lb/ft ² kg/m ²	Waterside ft ² /ft m ² /m	Landside ft ² /ft m ² /m
SECTION									
HZ 630M	17.55 371.4	1,759.4 240,250	145.1 7,800	132.8 7,140	52.40 256	56.06 274	59.72 292	10.32 3.145	17.62 5.371
HZ 880M A	16.46 348.4	2,692.6 367,690	170.1 9,145	156.7 8,425	48.91 239	52.46 256	56.01 273	10.57 3.222	19.21 5.854
HZ 880M B	17.60 372.4	2,885.1 393,980	181.4 9,750	167.9 9,025	52.79 258	56.34 275	59.88 292	10.59 3.229	19.23 5.860
HZ 880M C	18.12 383.6	3,020.2 412,430	188.9 10,160	175.8 9,450	54.58 266	58.12 284	61.67 301	10.59 3.228	19.23 5.860
HZ 1080M A	19.29 408.4	4,986.8 680,970	241.7 12,995	226.8 12,190	58.53 286	62.10 303	65.66 321	10.54 3.214	20.63 6.288
HZ 1080M B	20.12 425.9	5,344.2 729,790	257.5 13,845	243.0 13,065	61.35 300	64.91 317	68.47 334	10.55 3.216	20.64 6.290
HZ 1080M C	21.62 457.6	5,778.4 789,080	276.9 14,885	262.8 14,130	66.46 324	70.01 342	73.57 359	10.56 3.219	20.65 6.293
HZ 1080M D	22.84 483.4	6,204.6 847,280	295.1 15,865	282.2 15,170	70.61 345	74.17 362	77.72 379	10.57 3.220	20.65 6.294
HZ 1180M A	23.81 503.9	6,523.9 890,880	308.0 16,560	296.7 15,955	73.92 361	77.47 378	81.02 396	10.57 3.222	20.65 6.296
HZ 1180M B	24.39 516.2	6,785.7 926,630	319.2 17,160	308.6 16,595	75.90 371	79.45 388	83.00 405	10.58 3.225	20.67 6.299
HZ 1180M C	25.86 547.4	7,323.8 1,000,110	342.0 18,390	330.3 17,760	80.56 393	84.29 412	88.01 430	10.64 3.242	20.79 6.337
HZ 1180M D	26.73 565.7	7,602.6 1,038,190	353.8 19,020	342.9 18,435	83.51 408	87.23 426	90.96 444	10.68 3.254	20.83 6.349

* Referring outside of HZ[®]-M-flange (v₂), ** Referring outside of connector (v₃), *** Length of connectors = Length of AZ.

HZ[®]-M STEEL WALL SYSTEMS

Combination HZ...M-12 / AZ 23-800

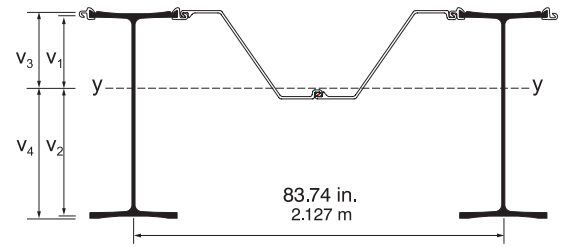

SECTION	PROPERTIES PER FOOT OF WALL				MASS OF COMBINATION WITH INTERMEDIARY SECTION				
	Sectional Area in ² /ft cm ² /m	Moment of Inertia in ⁴ /ft cm ⁴ /m	*Elastic Section Modulus in ³ /ft cm ³ /m	**Elastic Section Modulus in ³ /ft cm ³ /m	*** AZ 23-800			COATING AREA	
					£AZ = 60% £HZ lb/ft ² kg/m ²	£AZ = 80% £HZ lb/ft ² kg/m ²	£AZ = £HZ lb/ft ² kg/m ²	Waterside ft ² /ft m ² /m	Landside ft ² /ft m ² /m
HZ 630M	13.35 282.6	1,190.2 162,520	88.9 4,780	99.5 5,350	36.76 179	41.10 201	45.44 222	8.84 2.694	15.22 4.639
HZ 880M A	12.75 270.0	1,717.8 234,580	97.6 5,245	111.7 6,005	34.88 170	39.14 191	43.41 212	8.97 2.733	16.83 5.130
HZ 880M B	13.46 284.9	1,840.6 251,350	105.1 5,650	118.4 6,365	37.29 182	41.55 203	45.81 224	8.98 2.736	16.84 5.131
HZ 880M C	13.78 291.7	1,924.0 262,730	109.7 5,900	123.3 6,625	38.38 187	42.64 208	46.90 229	8.98 2.736	16.83 5.131
HZ 1080M A	14.48 306.4	3,041.1 415,280	135.1 7,260	151.5 8,145	40.72 199	44.99 220	49.26 241	8.95 2.729	18.27 5.567
HZ 1080M B	14.99 317.2	3,265.1 445,870	145.0 7,795	161.7 8,695	42.46 207	46.74 228	51.01 249	8.96 2.730	18.26 5.567
HZ 1080M C	15.91 336.7	3,534.8 482,700	157.3 8,455	173.7 9,340	45.60 223	49.87 243	54.14 264	8.96 2.731	18.27 5.569
HZ 1080M D	16.66 352.5	3,798.1 518,650	168.6 9,065	185.7 9,980	48.15 235	52.42 256	56.68 277	8.96 2.732	18.27 5.569
HZ 1180M A	17.25 365.2	3,995.9 545,660	176.8 9,505	194.6 10,465	50.18 245	54.45 266	58.71 287	8.97 2.733	18.27 5.570
HZ 1180M B	17.63 373.2	4,169.5 569,370	184.5 9,920	202.3 10,875	51.48 251	55.74 272	60.01 293	8.97 2.734	18.29 5.574
HZ 1180M C	18.37 388.8	4,424.3 604,160	194.4 10,450	214.2 11,515	53.86 263	58.19 284	62.52 305	9.01 2.747	18.32 5.583
HZ 1180M D	18.96 401.3	4,624.8 631,540	203.9 10,960	222.3 11,950	55.86 273	60.19 294	64.51 315	9.03 2.753	18.33 5.588

* Referring outside of HZ[®]-M-flange (v₂), ** Referring outside of connector (v₃), *** Length of connectors = Length of AZ.

HZ[®]-M STEEL WALL SYSTEMS

Combination HZ...M-14 / AZ 23-800

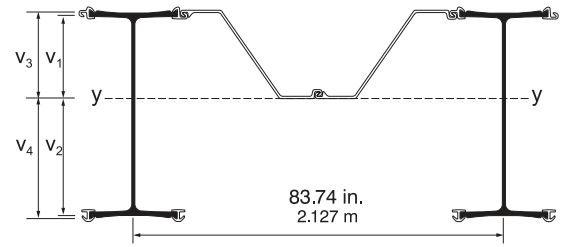

<small>JD</small> FIELDS <small>& COMPANY, INC.</small> <small>A FIELD COMPANY</small>	PROPERTIES PER FOOT OF WALL				MASS OF COMBINATION WITH INTERMEDIARY SECTION				
	Sectional Area in ² /ft cm ² /m	Moment of Inertia in ⁴ /ft cm ⁴ /m	*Elastic Section Modulus in ³ /ft cm ³ /m	**Elastic Section Modulus in ³ /ft cm ³ /m	*** AZ 23-800			COATING AREA	
					£AZ = 60% £HZ lb/ft ² kg/m ²	£AZ = 80% £HZ lb/ft ² kg/m ²	£AZ = £HZ lb/ft ² kg/m ²	Waterside ft ² /ft m ² /m	Landside ft ² /ft m ² /m
SECTION									
HZ 630M	14.18 300.2	1,321.9 180,510	108.9 5,855	99.7 5,365	38.35 187	43.31 211	48.27 236	8.84 2.694	16.14 4.920
HZ 880M A	13.58 287.4	1,949.5 266,210	123.1 6,615	113.4 6,095	36.47 178	41.34 202	46.21 226	8.97 2.733	17.60 5.365
HZ 880M B	14.28 302.2	2,067.8 282,380	129.9 6,985	120.3 6,465	38.85 190	43.72 213	48.58 237	8.98 2.736	17.61 5.368
HZ 880M C	14.60 309.0	2,150.4 293,650	134.4 7,230	125.1 6,725	39.94 195	44.81 219	49.68 243	8.98 2.736	17.61 5.368
HZ 1080M A	15.30 323.9	3,427.8 468,080	166.0 8,925	155.8 8,375	42.31 207	47.19 230	52.08 254	8.95 2.729	19.04 5.802
HZ 1080M B	15.81 334.6	3,645.9 497,860	175.6 9,440	165.7 8,910	44.03 215	48.91 239	53.79 263	8.96 2.730	19.04 5.803
HZ 1080M C	16.72 354.0	3,912.6 534,280	187.4 10,075	177.8 9,560	47.17 230	52.04 254	56.92 278	8.96 2.731	19.05 5.805
HZ 1080M D	17.47 369.8	4,173.7 569,950	198.4 10,665	189.7 10,200	49.71 243	54.59 267	59.46 290	8.96 2.732	19.05 5.806
HZ 1180M A	18.07 382.4	4,369.8 596,720	206.2 11,085	198.9 10,690	51.74 253	56.62 276	61.49 300	8.97 2.733	19.05 5.806
HZ 1180M B	18.42 390.0	4,529.7 618,550	212.9 11,450	205.9 11,070	52.95 259	57.82 282	62.70 306	8.97 2.734	19.05 5.808
HZ 1180M C	19.39 410.4	4,883.0 666,800	227.2 12,215	219.4 11,795	55.80 272	60.89 297	65.98 322	9.01 2.747	19.17 5.842
HZ 1180M D	19.92 421.6	5,054.7 690,250	234.4 12,600	227.2 12,215	57.61 281	62.70 306	67.79 331	9.03 2.753	19.19 5.848

* Referring outside of HZ[®]-M-flange (v₂), ** Referring outside of connector (v₃), *** Length of connectors = Length of AZ.

HZ[®]-M STEEL WALL SYSTEMS

Combination HZ...M-24 / AZ 23-800

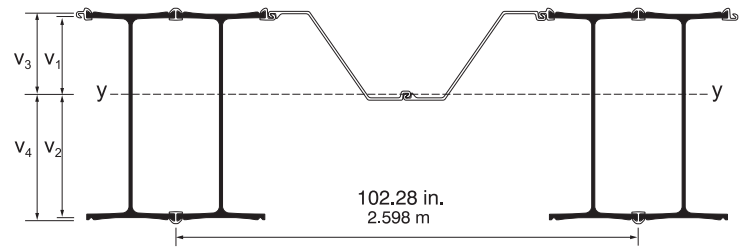

<small>JD</small> FIELDS <small>& COMPANY, INC.</small> <small>A FIELDS COMPANY</small>	PROPERTIES PER FOOT OF WALL				MASS OF COMBINATION WITH INTERMEDIARY SECTION				
	Sectional Area in ² /ft cm ² /m	Moment of Inertia in ⁴ /ft cm ⁴ /m	*Elastic Section Modulus in ³ /ft cm ³ /m	**Elastic Section Modulus in ³ /ft cm ³ /m	*** AZ 23-800			COATING AREA	
					£AZ = 60% £HZ lb/ft ² kg/m ²	£AZ = 80% £HZ lb/ft ² kg/m ²	£AZ = £HZ lb/ft ² kg/m ²	Waterside ft ² /ft m ² /m	Landside ft ² /ft m ² /m
SECTION									
HZ 630M	17.46 369.5	1,709.4 233,430	133.3 7,165	122.6 6,590	52.22 255	55.81 272	59.40 290	10.43 3.179	16.87 5.143
HZ 880M A	16.37 346.5	2,558.6 349,390	152.3 8,190	140.9 7,575	48.73 238	52.22 255	55.71 272	10.68 3.256	18.61 5.671
HZ 880M B	17.51 370.5	2,752.4 375,850	163.9 8,815	152.3 8,190	52.61 257	56.09 274	59.58 291	10.70 3.263	18.63 5.677
HZ 880M C	18.03 381.7	2,887.8 394,350	171.5 9,220	160.1 8,610	54.40 266	57.88 283	61.36 300	10.70 3.262	18.62 5.677
HZ 1080M A	19.20 406.5	4,719.0 644,410	217.9 11,715	205.0 11,025	58.35 285	61.85 302	65.35 319	10.66 3.248	20.03 6.105
HZ 1080M B	20.03 423.9	5,077.3 693,340	233.7 12,565	221.1 11,890	61.16 299	64.66 316	68.16 333	10.66 3.250	20.04 6.107
HZ 1080M C	21.53 455.7	5,513.2 752,870	253.4 13,625	241.0 12,960	66.27 324	69.77 341	73.26 358	10.67 3.253	20.05 6.110
HZ 1080M D	22.75 481.5	5,940.6 811,230	271.9 14,615	260.4 14,000	70.43 344	73.92 361	77.41 378	10.68 3.255	20.05 6.111
HZ 1180M A	23.72 502.0	6,260.8 854,950	285.0 15,325	275.0 14,785	73.74 360	77.23 377	80.71 394	10.68 3.256	20.05 6.113
HZ 1180M B	24.30 514.3	6,522.9 890,740	296.2 15,925	286.8 15,420	75.72 370	79.21 387	82.69 404	10.69 3.259	20.08 6.122
HZ 1180M C	25.59 541.6	6,981.9 953,420	315.5 16,965	305.0 16,400	80.00 391	83.54 408	87.08 425	10.75 3.276	20.13 6.135
HZ 1180M D	26.45 559.9	7,261.6 991,610	327.5 17,605	317.7 17,080	82.95 405	86.49 422	90.02 440	10.79 3.289	20.16 6.144

* Referring outside of HZ[®]-M-flange (v₂), ** Referring outside of connector (v₃), *** Length of connectors = Length of AZ.

HZ[®]-M STEEL WALL SYSTEMS

Combination HZ...M-26 / AZ 23-800

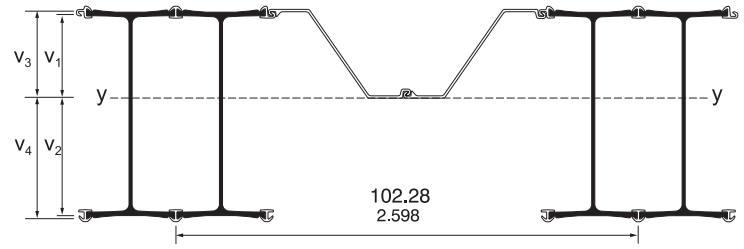



SECTION	PROPERTIES PER FOOT OF WALL				MASS OF COMBINATION WITH INTERMEDIARY SECTION				
	Sectional Area in ² /ft cm ² /m	Moment of Inertia in ⁴ /ft cm ⁴ /m	*Elastic Section Modulus in ³ /ft cm ³ /m	**Elastic Section Modulus in ³ /ft cm ³ /m	*** AZ 23-800			COATING AREA	
					£AZ = 60% £HZ lb/ft ² kg/m ²	£AZ = 80% £HZ lb/ft ² kg/m ²	£AZ = £HZ lb/ft ² kg/m ²	Waterside ft ² /ft m ² /m	Landside ft ² /ft m ² /m
HZ 630M	18.21 385.4	1,824.1 249,090	150.4 8,085	137.7 7,405	53.75 262	57.86 283	61.97 303	10.43 3.179	17.73 5.405
HZ 880M A	17.10 362.0	2,755.4 376,270	174.1 9,360	160.3 8,620	50.22 245	54.21 265	58.19 284	10.68 3.256	19.32 5.888
HZ 880M B	18.24 386.0	2,947.9 402,550	185.3 9,965	171.5 9,225	54.10 264	58.08 284	62.06 303	10.70 3.263	19.34 5.894
HZ 880M C	18.76 397.1	3,082.9 420,990	192.9 10,370	179.4 9,645	55.89 273	59.87 292	63.85 312	10.70 3.262	19.34 5.894
HZ 1080M A	19.94 422.0	5,049.8 689,580	244.7 13,155	229.6 12,345	59.85 292	63.85 312	67.85 331	10.66 3.248	20.74 6.322
HZ 1080M B	20.76 439.5	5,407.2 738,390	260.6 14,010	245.9 13,220	62.66 306	66.66 325	70.66 345	10.66 3.250	20.75 6.324
HZ 1080M C	22.26 471.2	5,841.3 797,670	279.9 15,050	265.7 14,285	67.77 331	71.76 350	75.75 370	10.67 3.253	20.76 6.327
HZ 1080M D	23.48 497.0	6,267.5 855,860	298.1 16,025	285.1 15,325	71.92 351	75.91 371	79.90 390	10.68 3.255	20.76 6.328
HZ 1180M A	24.45 517.5	6,586.7 899,460	311.0 16,720	299.6 16,105	75.23 367	79.22 387	83.20 406	10.68 3.256	20.77 6.330
HZ 1180M B	25.03 529.8	6,848.5 935,210	322.1 17,320	311.5 16,745	77.21 377	81.20 396	85.18 416	10.69 3.259	20.78 6.333
HZ 1180M C	26.50 561.0	7,386.5 1,008,670	344.9 18,545	333.1 17,910	81.87 400	86.03 420	90.19 440	10.75 3.276	20.90 6.371
HZ 1180M D	27.37 579.3	7,665.3 1,046,740	356.7 19,180	345.8 18,590	84.82 414	88.98 434	93.14 455	10.79 3.289	20.94 6.383

* Referring outside of HZ[®]-M-flange (v₂), ** Referring outside of connector (v₃), *** Length of connectors = Length of AZ.

HZ[®]-M STEEL WALL SYSTEMS

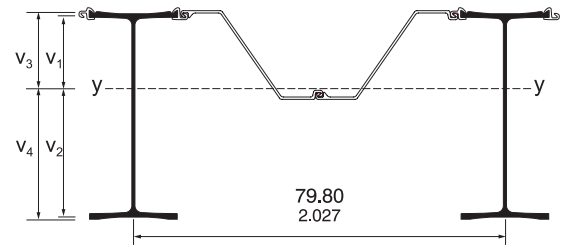
Combination HZ...M-12 / AZ 28-750



 SECTION	PROPERTIES PER FOOT OF WALL				MASS OF COMBINATION WITH INTERMEDIARY SECTION				
	Sectional Area in ² /ft cm ² /m	Moment of Inertia in ⁴ /ft cm ⁴ /m	*Elastic Section Modulus in ³ /ft cm ³ /m	**Elastic Section Modulus in ³ /ft cm ³ /m	*** AZ 28-750			COATING AREA	
					£AZ = 60% £HZ lb/ft ² kg/m ²	£AZ = 80% £HZ lb/ft ² kg/m ²	£AZ = £HZ lb/ft ² kg/m ²	Waterside ft ² /ft m ² /m	Landside ft ² /ft m ² /m
HZ 630M	14.40 304.8	1,319.5 180,190	98.5 5,295	110.3 5,930	39.37 192	44.19 216	49.00 239	8.84 2.693	15.22 4.638
HZ 880M A	13.75 291.1	1,870.8 255,460	106.2 5,710	121.7 6,540	37.35 182	42.08 205	46.80 229	8.96 2.732	16.83 5.128
HZ 880M B	14.49 306.7	1,999.5 273,040	114.2 6,135	128.6 6,915	39.88 195	44.60 218	49.31 241	8.97 2.735	16.83 5.130
HZ 880M C	14.83 313.8	2,086.9 284,980	119.0 6,400	133.7 7,190	41.02 200	45.74 223	50.46 246	8.97 2.735	16.83 5.130
HZ 1080M A	15.56 329.4	3,259.8 445,140	144.8 7,785	162.4 8,730	43.49 212	48.22 235	52.95 259	8.95 2.728	18.26 5.566
HZ 1080M B	16.10 340.7	3,494.8 477,230	155.2 8,345	173.1 9,305	45.32 221	50.05 244	54.78 267	8.95 2.729	18.26 5.566
HZ 1080M C	17.06 361.1	3,777.6 515,860	168.1 9,035	185.7 9,980	48.61 237	53.33 260	58.06 283	8.96 2.730	18.27 5.567
HZ 1080M D	17.85 377.7	4,053.7 553,560	180.0 9,675	198.2 10,655	51.28 250	56.00 273	60.73 297	8.96 2.731	18.27 5.568
HZ 1180M A	18.47 390.9	4,261.2 581,890	188.5 10,135	207.5 11,155	53.41 261	58.13 284	62.86 307	8.96 2.732	18.27 5.569
HZ 1180M B	18.87 399.4	4,443.3 606,760	196.6 10,570	215.5 11,590	54.77 267	59.49 290	64.22 314	8.97 2.733	18.28 5.573
HZ 1180M C	19.64 415.8	4,710.6 643,260	207.0 11,130	228.0 12,260	57.27 280	62.06 303	66.85 326	9.01 2.746	18.31 5.582
HZ 1180M D	20.26 428.8	4,920.8 671,960	216.9 11,665	236.5 12,715	59.36 290	64.15 313	68.94 337	9.03 2.752	18.33 5.587

* Referring outside of HZ[®]-M-flange (v₂), ** Referring outside of connector (v₃), *** Length of connectors = Length of AZ.

HZ[®]-M STEEL WALL SYSTEMS

Combination HZ...M-14 / AZ 28-750

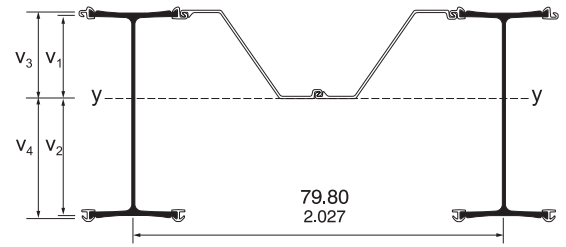



SECTION	PROPERTIES PER FOOT OF WALL				MASS OF COMBINATION WITH INTERMEDIARY SECTION				
	Sectional Area in ² /ft cm ² /m	Moment of Inertia in ⁴ /ft cm ⁴ /m	*Elastic Section Modulus in ³ /ft cm ³ /m	**Elastic Section Modulus in ³ /ft cm ³ /m	*** AZ 28-750			COATING AREA	
					£AZ = 60% £HZ lb/ft ² kg/m ²	£AZ = 80% £HZ lb/ft ² kg/m ²	£AZ = £HZ lb/ft ² kg/m ²	Waterside ft ² /ft m ² /m	Landside ft ² /ft m ² /m
HZ 630M	15.27 323.2	1,457.8 199,080	120.1 6,460	110.0 5,915	41.04 200	46.51 227	51.97 254	8.84 2.693	16.14 4.919
HZ 880M A	14.62 309.4	2,113.8 288,660	133.4 7,175	122.9 6,610	39.02 190	44.38 217	49.74 243	8.96 2.732	17.60 5.364
HZ 880M B	15.35 324.8	2,237.9 305,600	140.6 7,560	130.1 6,995	41.51 203	46.87 229	52.23 255	8.97 2.735	17.61 5.367
HZ 880M C	15.68 332.0	2,324.5 317,430	145.3 7,815	135.2 7,270	42.66 208	48.02 234	53.37 261	8.97 2.735	17.61 5.367
HZ 1080M A	16.43 347.7	3,665.5 500,550	177.5 9,545	166.6 8,955	45.16 220	50.53 247	55.90 273	8.95 2.728	19.03 5.801
HZ 1080M B	16.96 358.9	3,894.4 531,800	187.5 10,085	177.0 9,515	46.96 229	52.33 256	57.70 282	8.95 2.729	19.04 5.802
HZ 1080M C	17.92 379.3	4,174.0 569,980	199.9 10,745	189.7 10,200	50.25 245	55.61 272	60.98 298	8.96 2.730	19.04 5.804
HZ 1080M D	18.70 395.9	4,447.9 607,390	211.4 11,365	202.2 10,870	52.92 258	58.28 285	63.65 311	8.96 2.731	19.04 5.804
HZ 1180M A	19.33 409.1	4,653.5 635,460	219.6 11,805	211.8 11,385	55.05 269	60.41 295	65.77 321	8.96 2.732	19.05 5.805
HZ 1180M B	19.70 417.0	4,821.3 658,370	226.7 12,185	219.2 11,785	56.32 275	61.68 301	67.04 327	8.97 2.733	19.05 5.807
HZ 1180M C	20.71 438.4	5,191.9 708,980	241.6 12,985	233.3 12,545	59.30 290	64.89 317	70.48 344	9.01 2.746	19.16 5.841
HZ 1180M D	21.27 450.2	5,371.9 733,570	249.1 13,390	241.5 12,980	61.20 299	66.79 326	72.38 353	9.03 2.752	19.18 5.847

* Referring outside of HZ[®]-M-flange (v₂), ** Referring outside of connector (v₃), *** Length of connectors = Length of AZ.

HZ[®]-M STEEL WALL SYSTEMS

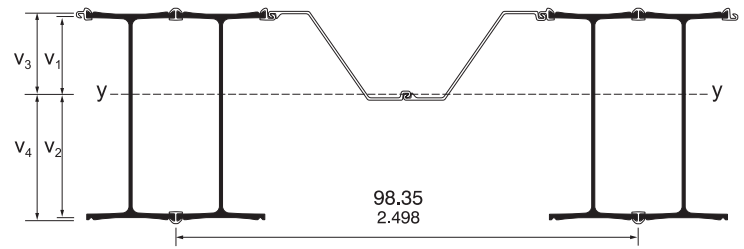
Combination HZ...M-24 / AZ 28-750



 SECTION	PROPERTIES PER FOOT OF WALL				MASS OF COMBINATION WITH INTERMEDIARY SECTION				
	Sectional Area in ² /ft cm ² /m	Moment of Inertia in ⁴ /ft cm ⁴ /m	*Elastic Section Modulus in ³ /ft cm ³ /m	**Elastic Section Modulus in ³ /ft cm ³ /m	*** AZ 28-750			COATING AREA	
					£AZ = 60% £HZ lb/ft ² kg/m ²	£AZ = 80% £HZ lb/ft ² kg/m ²	£AZ = £HZ lb/ft ² kg/m ²	Waterside ft ² /ft m ² /m	Landside ft ² /ft m ² /m
HZ 630M	18.48 391.2	1,837.0 250,860	143.2 7,700	131.8 7,085	55.00 269	58.95 288	62.90 307	10.43 3.178	16.87 5.142
HZ 880M A	17.32 366.6	2,716.3 370,930	161.7 8,695	149.6 8,045	51.29 250	55.12 269	58.95 288	10.68 3.255	18.60 5.670
HZ 880M B	18.50 391.7	2,917.5 398,410	173.8 9,340	161.5 8,680	55.32 270	59.14 289	62.97 307	10.70 3.262	18.62 5.676
HZ 880M C	19.05 403.2	3,058.4 417,650	181.7 9,765	169.6 9,120	57.18 279	61.00 298	64.83 317	10.70 3.261	18.62 5.676
HZ 1080M A	20.27 429.1	4,963.9 677,850	229.2 12,320	215.7 11,595	61.30 299	65.15 318	68.99 337	10.65 3.247	20.02 6.103
HZ 1080M B	21.13 447.3	5,336.6 728,740	245.7 13,205	232.4 12,495	64.23 314	68.07 332	71.92 351	10.66 3.249	20.03 6.106
HZ 1080M C	22.69 480.2	5,789.6 790,600	266.1 14,310	253.1 13,610	69.54 340	73.38 358	77.21 377	10.67 3.252	20.04 6.109
HZ 1080M D	23.96 507.1	6,233.8 851,270	285.3 15,340	273.3 14,690	73.86 361	77.69 379	81.53 398	10.67 3.253	20.05 6.110
HZ 1180M A	24.96 528.4	6,566.6 896,710	298.9 16,075	288.4 15,505	77.30 377	81.13 396	84.96 415	10.68 3.255	20.05 6.112
HZ 1180M B	25.57 541.2	6,839.2 933,930	310.6 16,700	300.7 16,165	79.35 387	83.19 406	87.02 425	10.69 3.258	20.08 6.121
HZ 1180M C	26.91 569.5	7,316.0 999,040	330.6 17,775	319.6 17,185	83.80 409	87.68 428	91.57 447	10.75 3.275	20.12 6.134
HZ 1180M D	27.81 588.6	7,606.6 1,038,720	343.0 18,440	332.8 17,895	86.87 424	90.75 443	94.63 462	10.79 3.287	20.15 6.143

* Referring outside of HZ[®]-M-flange (v₂), ** Referring outside of connector (v₃), *** Length of connectors = Length of AZ.

HZ[®]-M STEEL WALL SYSTEMS

Combination HZ...M-26 / AZ 28-750

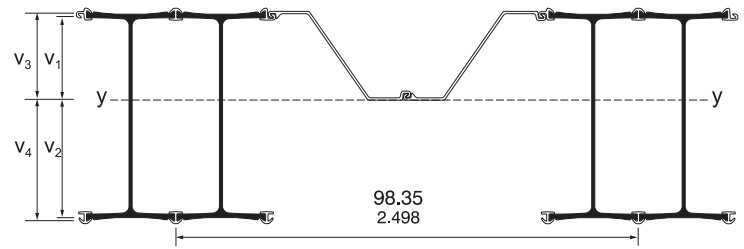

SECTION	PROPERTIES PER FOOT OF WALL				MASS OF COMBINATION WITH INTERMEDIARY SECTION				
	Sectional Area in ² /ft cm ² /m	Moment of Inertia in ⁴ /ft cm ⁴ /m	*Elastic Section Modulus in ³ /ft cm ³ /m	**Elastic Section Modulus in ³ /ft cm ³ /m	*** AZ 28-750			COATING AREA	
					£AZ = 60% £HZ lb/ft ² kg/m ²	£AZ = 80% £HZ lb/ft ² kg/m ²	£AZ = £HZ lb/ft ² kg/m ²	Waterside ft ² /ft m ² /m	Landside ft ² /ft m ² /m
HZ 630M	19.27 407.8	1,956.4 267,160	161.3 8,670	147.7 7,940	56.60 276	61.09 298	65.57 320	10.43 3.178	17.73 5.404
HZ 880M A	18.08 382.7	2,921.0 398,880	184.5 9,920	170.0 9,140	52.84 258	57.19 279	61.54 300	10.68 3.255	19.31 5.887
HZ 880M B	19.26 407.7	3,120.9 426,170	196.2 10,550	181.6 9,765	56.87 278	61.21 299	65.55 320	10.70 3.262	19.34 5.893
HZ 880M C	19.81 419.3	3,261.3 445,360	204.0 10,970	189.8 10,205	58.73 287	63.07 308	67.41 329	10.70 3.261	19.33 5.893
HZ 1080M A	21.04 445.3	5,308.0 724,830	257.2 13,830	241.4 12,980	62.86 307	67.22 328	71.59 350	10.65 3.247	20.74 6.321
HZ 1080M B	21.90 463.5	5,679.7 775,600	273.7 14,715	258.3 13,885	65.79 321	70.15 343	74.51 364	10.66 3.249	20.74 6.323
HZ 1080M C	23.45 496.4	6,130.8 837,200	293.8 15,795	278.8 14,990	71.09 347	75.45 368	79.81 390	10.67 3.252	20.75 6.326
HZ 1080M D	24.72 523.2	6,573.8 897,690	312.7 16,810	299.0 16,075	75.41 368	79.77 389	84.12 411	10.67 3.253	20.76 6.327
HZ 1180M A	25.73 544.5	6,905.6 943,000	326.0 17,530	314.1 16,885	78.85 385	83.20 406	87.55 427	10.68 3.255	20.76 6.329
HZ 1180M B	26.33 557.3	7,177.8 980,180	337.6 18,150	326.5 17,555	80.91 395	85.26 416	89.61 438	10.69 3.258	20.77 6.332
HZ 1180M C	27.86 589.7	7,736.8 1,056,500	361.3 19,425	348.9 18,760	85.75 419	90.28 441	94.81 463	10.75 3.275	20.90 6.370
HZ 1180M D	28.76 608.7	8,026.4 1,096,060	373.5 20,080	362.0 19,465	88.81 434	93.34 456	97.87 478	10.79 3.287	20.94 6.382

* Referring outside of HZ[®]-M-flange (v₂), ** Referring outside of connector (v₃), *** Length of connectors = Length of AZ.

HZ[®]-M STEEL WALL SYSTEMS

Combination C 1

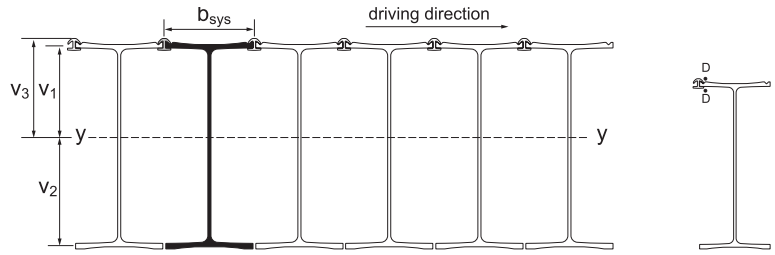

D = discontinuous weld, a = 0.236" (6 mm), 10% of length (3.94" per 3.28', 100 mm/m) over the whole pile length + 19.68" (500 mm) continuous weld at top and toe

FIELDSD & COMPANY, INC. SECTION	DIMENSIONS					PROPERTIES PER FOOT OF WALL					COATING AREA	
	b _{sys} in mm	v ₁ in mm	v ₂ in mm	v ₃ in mm	v ₄ in mm	Sectional Area in ² /ft cm ² /m	Mass in ² /ft cm ² /m	Moment of Inertia in ⁴ /ft cm ⁴ /m	*Elastic Section Modulus in ³ /ft cm ³ /m	**Elastic Section Modulus in ³ /ft cm ³ /m	Waterside ft ² /ft m ² /m	Landside ft ² /ft m ² /m
HZ 630M	17.09 0.434	11.52 292.6	12.72 323.2	12.63 320.9	-	35.78 757.3	121.77 594.5	3971.6 542,340	312.1 16780	314.3 16900	1.68 0.513	8.20 2.500
HZ 880M A	18.70 0.475	14.96 379.9	16.67 423.5	16.31 414.3	-	31.28 662.1	106.46 519.8	5939.0 811,010	356.2 19150	364.1 19575	1.81 0.551	9.85 3.001
HZ 880M B	18.70 0.475	15.13 384.3	16.66 423.1	16.41 416.7	-	34.37 727.6	116.98 571.1	6464.9 882,820	388.1 20865	394.0 21185	1.82 0.554	9.85 3.003
HZ 880M C	18.70 0.475	15.24 387.1	16.71 424.3	16.44 417.5	-	35.81 758.1	121.88 595.1	6836.8 933,600	409.2 22000	415.9 22360	1.82 0.554	9.85 3.002
HZ 1080M A	18.50 0.470	19.72 500.8	21.52 546.6	21.07 535.2	-	39.25 830.8	133.58 652.2	11646.2 1,590,360	541.2 29095	552.7 29715	1.79 0.547	11.28 3.439
HZ 1080M B	18.50 0.470	19.90 505.5	21.57 547.9	21.14 536.9	-	41.58 880.0	141.49 690.8	12654.9 1,728,110	586.6 31540	598.6 32185	1.80 0.548	11.28 3.438
HZ 1080M C	18.50 0.470	20.10 510.5	21.61 548.9	21.22 538.9	-	45.62 965.7	155.26 758.0	13825.6 1,887,970	639.7 34395	651.7 35035	1.80 0.549	11.29 3.440
HZ 1080M D	18.50 0.470	20.31 515.8	21.72 551.6	21.27 540.2	-	48.93 1035.8	166.53 813.1	14985.9 2,046,410	690.1 37100	704.6 37880	1.80 0.550	11.29 3.440
HZ 1180M A	18.70 0.475	20.50 520.8	21.84 554.6	21.31 541.2	-	51.55 1091.2	175.45 856.6	15849.3 2,164,320	725.9 39025	743.8 39990	1.81 0.551	11.29 3.441
HZ 1180M B	18.70 0.475	20.65 524.5	21.85 554.9	21.37 542.9	-	53.27 1127.6	181.29 885.2	16625.5 2,270,310	760.9 40910	777.9 41820	1.82 0.553	11.31 3.447
HZ 1180M C	18.70 0.475	20.58 522.7	22.07 560.7	21.34 542.0	-	56.34 1192.6	191.75 936.2	17709.1 2,418,290	802.2 43130	829.8 44615	1.83 0.558	11.37 3.465
HZ 1180M D	18.70 0.475	20.78 527.8	22.03 559.6	21.46 545.1	-	58.89 1246.5	200.40 978.5	18567.9 2,535,560	842.8 45310	865.2 46515	1.85 0.564	11.39 3.472

* Referring outside of HZ[®]-M-flange (v₂). ** Referring outside of connector (v₃).

HZ[®]-M STEEL WALL SYSTEMS

Combination C 23

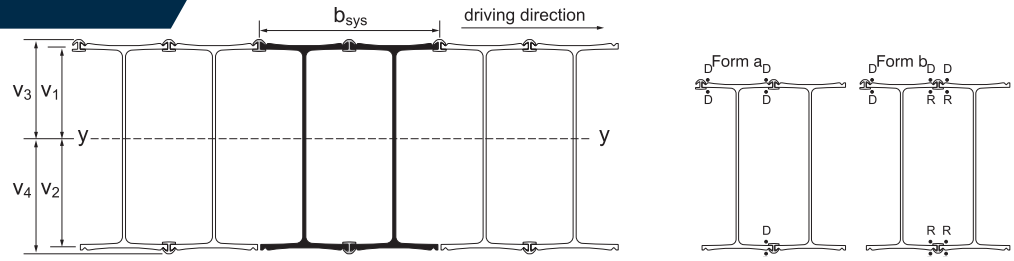

D = discontinuous weld, a = 0.236" (6 mm), 10% of length (3.94" per 3.28', 100 mm/m) over the whole pile length + 19.68" (500 mm) continuous weld at top and toe
 R = continuous weld, a = 0.236" (6 mm), length 19.68" (500 mm) at top and toe only

FIELDSD & COMPANY, INC. SECTION	DIMENSIONS					PROPERTIES PER FOOT OF WALL					COATING AREA	
	b _{sys} in mm	v ₁ in mm	v ₂ in mm	v ₃ in mm	v ₄ in mm	Sectional Area in ² /ft cm ² /m	Mass in ² /ft cm ² /m	Moment of Inertia in ⁴ /ft cm ⁴ /m	*Elastic Section Modulus in ³ /ft cm ³ /m	**Elastic Section Modulus in ³ /ft cm ³ /m	Waterside ft ² /ft m ² /m	Landside ft ² /ft m ² /m
HZ 630M	34.17 0.868	11.76 298.7	12.48 317.0	12.88 327.1	13.59 345.3	36.50 772.5	124.21 606.4	4080.4 557,210	327.0 17580	300.1 16135	3.27 0.998	9.82 2.992
HZ 880M A	37.40 0.950	15.31 389.0	16.32 414.4	16.67 423.4	17.67 448.9	31.97 676.7	108.81 531.2	6126.0 836,540	375.4 20185	346.6 18635	3.53 1.074	11.62 3.542
HZ 880M B	37.40 0.950	15.44 392.1	16.35 415.3	16.72 424.6	17.63 447.7	35.03 741.5	119.21 582.0	6641.1 906,880	406.2 21840	376.7 20255	3.55 1.081	11.64 3.549
HZ 880M C	37.40 0.950	15.54 394.6	16.41 416.8	16.73 425.1	17.61 447.3	36.47 772.0	124.12 606.0	7012.4 957,590	427.3 22975	398.2 21410	3.54 1.080	11.64 3.548
HZ 1080M A	37.01 0.940	20.09 510.3	21.14 537.1	21.45 544.8	22.50 571.5	39.95 845.7	135.97 663.8	11964.3 1,633,800	565.8 30420	531.8 28590	3.50 1.066	13.04 3.976
HZ 1080M B	37.01 0.940	20.24 514.1	21.23 539.3	21.48 545.5	22.47 570.8	42.24 894.1	143.75 701.9	12954.8 1,769,060	610.1 32800	576.5 30995	3.51 1.068	13.05 3.978
HZ 1080M C	37.01 0.940	20.40 518.2	21.31 541.2	21.52 546.6	22.43 569.6	46.28 979.7	157.51 769.1	14122.5 1,928,510	662.8 35635	629.7 33855	3.52 1.072	13.06 3.981
HZ 1080M D	37.01 0.940	20.59 523.0	21.43 544.4	21.55 547.4	22.39 568.8	49.60 1049.8	168.79 824.1	15280.9 2,086,700	712.9 38330	682.3 36685	3.52 1.073	13.07 3.982
HZ 1180M A	37.40 0.950	20.77 527.6	21.57 547.8	21.57 548.0	22.37 568.3	52.21 1105.1	177.69 867.5	16141.6 2,204,240	748.4 40235	721.5 38790	3.52 1.074	13.07 3.984
HZ 1180M B	37.40 0.950	20.86 529.9	21.64 549.5	21.59 548.3	22.36 568.0	53.81 1139.1	183.14 894.2	16862.8 2,302,720	779.4 41905	754.1 40545	3.54 1.078	13.11 3.995
HZ 1180M C	37.40 0.950	20.87 530.2	21.78 553.2	21.63 549.5	22.54 572.5	57.14 1209.4	194.45 949.4	18058.9 2,466,050	829.1 44575	801.2 43075	3.57 1.087	13.18 4.017
HZ 1180M D	37.40 0.950	20.97 532.7	21.84 554.8	21.65 549.9	22.52 572.0	59.44 1258.2	202.29 987.7	18800.1 2,567,270	860.8 46280	834.8 44880	3.61 1.099	13.21 4.025

* Referring outside of HZ[®]-M-flange (v₂). ** Referring outside of connector (v₃).

AZ - Intermediary Piles

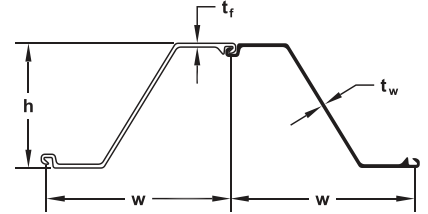

SECTION	Width (w) in mm	Height (h) in mm	THICKNESS		Cross Sectional Area in ² /ft cm ² /m	WEIGHT		SECTION MODULUS		Moment of Inertia in ⁴ /ft cm ⁴ /m	COATING AREA	
			Flange (t _f) in mm	Web (t _w) in mm		Single Pile lb/ft kg/m	Wall Area lb/ft ² kg/m ²	Elastic in ³ /ft cm ³ /m	Plastic in ³ /ft cm ³ /m		Both Sides ft ² /of single m ² /m ²	Wall Surface ft ² /ft m ² /m ²
AZ 12-770	30.31 770	13.52 344	0.335 8.5	0.335 8.5	5.67 120.1	48.78 72.6	19.31 94.3	23.2 1245	27.5 1480	156.9 21430	6.07 1.85	1.20 1.20
AZ 13-770	30.31 770	13.54 344	0.354 9.0	0.354 9.0	5.94 125.8	51.14 76.1	20.24 98.8	24.2 1300	28.8 1546	163.7 22360	6.07 1.85	1.20 1.20
AZ 14-770	30.31 770	13.56 345	0.375 9.5	0.375 9.5	6.21 131.5	53.42 79.5	21.14 103.2	25.2 1355	30.0 1611	170.6 23300	6.07 1.85	1.20 1.20
AZ 17-700	27.56 700	16.52 420	0.335 8.5	0.335 8.5	6.28 133.0	49.12 73.1	21.38 104.4	32.2 1730	37.7 2027	265.3 36230	6.10 1.86	1.33 1.33
AZ 18-700	27.56 700	16.54 420	0.354 9.0	0.354 9.0	6.58 139.2	51.41 76.5	22.39 109.3	33.5 1800	39.4 2116	276.8 37800	6.10 1.86	1.33 1.33
AZ 19-700	27.56 700	16.56 421	0.375 9.5	0.375 9.5	6.88 145.6	53.76 80.0	23.35 114.3	34.8 1870	41.0 2206	288.4 39380	6.10 1.86	1.33 1.33
AZ 20-700	27.56 700	16.57 421	0.394 10.0	0.394 10.0	7.18 152.0	56.11 83.5	24.43 119.3	36.2 1945	42.7 2296	300.0 40960	6.10 1.86	1.33 1.33
AZ 18-800	31.5 800	17.68 449	0.335 8.5	0.335 8.5	6.07 128.6	54.26 80.7	20.67 100.9	34.2 1840	39.7 2135	302.6 41320	6.82 2.08	1.30 1.30
AZ 20-800	31.5 800	17.72 450	0.375 9.5	0.375 9.5	6.66 141.0	59.50 88.6	22.67 110.7	37.2 2000	43.3 2330	329.9 45050	6.82 2.08	1.30 1.30
AZ 22-800	31.5 800	17.76 451	0.413 10.5	0.413 10.5	7.25 153.5	64.77 96.4	24.68 120.5	40.3 2165	47.0 2525	357.3 48790	6.82 2.08	1.30 1.30
AZ 23-800	31.50 800	18.66 474	0.453 11.5	0.354 9.0	7.12 150.6	63.56 94.6	24.22 118.2	43.3 2330	49.9 2680	404.6 55260	6.94 2.11	1.32 1.32
AZ 25-800	31.50 800	18.70 475	0.492 12.5	0.394 10.0	7.71 163.3	68.91 102.6	26.26 128.2	46.5 2500	53.8 2890	435.1 59410	6.94 2.11	1.32 1.32
AZ 27-800	31.50 800	18.74 476	0.531 13.5	0.433 11.0	8.31 176.0	74.26 110.5	28.29 138.1	49.7 2670	57.6 3100	465.5 63570	6.94 2.11	1.32 1.32
AZ 24-700	27.56 700	18.07 459	0.441 11.2	0.441 11.2	8.23 174.1	64.30 95.7	28.00 136.7	45.2 2430	53.5 2867	408.8 55820	6.33 1.93	1.38 1.38
AZ 26-700	27.56 700	18.11 460	0.480 12.2	0.480 12.2	8.84 187.2	69.12 102.9	30.10 146.9	48.4 2600	57.1 3070	437.3 59720	6.33 1.93	1.38 1.38
AZ 28-700	27.56 700	18.15 461	0.520 13.2	0.520 13.2	9.46 200.2	73.93 110.0	32.19 157.2	51.3 2760	60.9 3273	465.9 63620	6.33 1.93	1.38 1.38
AZ 28-750	29.53 750.0	20.04 509.0	0.472 12.00	0.394 10.00	8.09 171.2	67.73 100.80	27.53 134.40	52.3 2810	60.3 3245	523.9 71540	6.93 2.11	1.41 1.41
AZ 30-750	29.53 750.0	20.08 510.0	0.512 13.00	0.433 11.00	8.73 184.7	73.08 108.80	29.70 145.00	55.9 3005	64.8 3485	561.5 76670	6.93 2.11	1.41 1.41
AZ 32-750	29.53 750.0	20.12 511.0	0.551 14.00	0.472 12.00	9.37 198.3	78.44 116.70	31.88 155.60	59.5 3200	69.2 3720	599.0 81800	6.93 2.11	1.41 1.41
AZ 36-700N	27.56 700	19.65 499	0.591 15.0	0.441 11.2	10.20 215.9	79.72 118.6	34.71 169.5	66.8 3590	76.4 4110	656.2 89610	6.73 2.05	1.47 1.47
AZ 38-700N	27.56 700	19.69 500	0.630 16.0	0.480 12.2	10.87 230.0	84.94 126.4	36.98 180.6	70.6 3795	81.1 4360	694.5 94840	6.73 2.05	1.47 1.47
AZ 40-700N	27.56 700	19.72 501	0.669 17.0	0.520 13.2	11.54 244.2	90.16 134.2	39.26 191.7	74.3 3995	85.7 4605	732.9 100080	6.73 2.05	1.47 1.47
AZ 42-700N	27.56 700	19.65 499	0.709 18.0	0.551 14.0	12.22 258.7	95.51 142.1	41.59 203.1	78.2 4205	90.3 4855	768.4 104930	6.75 2.06	1.47 1.47
AZ 44-700N	27.56 700	19.69 500	0.748 19.0	0.591 15.0	12.89 272.8	100.74 149.9	43.87 214.2	81.9 4405	95.0 5105	806.6 110150	6.75 2.06	1.47 1.47
AZ 46-700N	27.56 700	19.72 501	0.787 20.0	0.630 16.0	13.56 287.0	105.97 157.7	46.14 225.3	85.7 4605	99.5 5350	844.9 115370	6.75 2.06	1.47 1.47
AZ 48-700	27.56 700.0	19.80 503.0	0.866 22.00	0.591 15.00	13.63 288.4	106.49 158.50	46.37 226.40	88.4 4755	102.1 5490	876.2 119650	6.70 2.04	1.46 1.46
AZ 50-700	27.56 700.0	19.84 504.0	0.906 23.00	0.630 16.00	14.30 302.6	111.73 166.30	48.65 237.50	92.2 4955	106.7 5735	914.6 124890	6.70 2.04	1.46 1.46
AZ 52-700	27.56 700.0	19.88 505.0	0.945 24.00	0.669 17.00	14.97 317.0	116.97 174.10	50.93 248.70	95.9 5155	111.3 5985	953.0 130140	6.70 2.04	1.46 1.46

HZ[®]-M STEEL WALL SYSTEMS

HZ[®]-M - King Pile

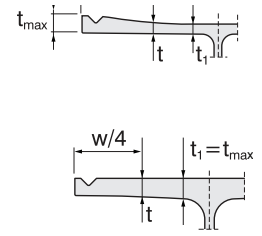
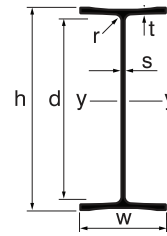

	DIMENSIONS									Suitable Connector		
	h	h ₁	d	w	t ₁	t _{max}	t	s	r			
SECTION	in mm	in mm	in mm	in mm	in mm	in mm	in mm	in mm	in mm	in mm		
HZ 630M	24.86 631.4	24.24 615.7	20.08 510.1	16.54 420.0	0.89 22.7	1.14 29.0	0.67 16.9	0.63 16.0	1.18 30.0	RZD/RZU 16	RH 16	
HZ 880M A	32.73 831.3	31.63 803.4	28.72 729.4	18.03 458.0	0.67 17.0	1.14 29.0	0.74 18.9	0.51 13.0	0.79 20.0	RZD/RZU 16	RH 16	
HZ 880M B	32.73 831.3	31.79 807.4	28.72 729.4	18.11 460.0	0.75 19.0	1.14 29.0	0.82 20.9	0.59 15.0	0.79 20.0	RZD/RZU 16	RH 16	
HZ 880M C	32.73 831.3	31.94 811.4	28.72 729.4	18.11 460.0	0.83 21.0	1.14 29.0	0.90 22.9	0.59 15.0	0.79 20.0	RZD/RZU 16	RH 16	
HZ 1080M A	42.33 1075.3	41.24 1047.4	37.23 945.6	17.87 454.0	0.81 20.7	1.14 29.0	0.77 19.6	0.63 16.0	1.18 30.0	RZD/RZU 16	RH 16	
HZ 1080M B	42.33 1075.3	41.47 1053.4	37.23 945.6	17.87 454.0	0.93 23.7	1.14 29.0	0.89 22.6	0.63 16.0	1.18 30.0	RZD/RZU 16	RH 16	
HZ 1080M C	42.33 1075.3	41.71 1059.4	37.23 945.6	17.95 456.0	1.05 26.7	1.14 29.0	1.01 25.7	0.71 18.0	1.18 30.0	RZD/RZU 16	RH 16	
HZ 1080M D	42.33 1075.3	42.02 1067.4	37.23 945.6	17.99 457.0	1.21 30.7	1.21 30.7	1.17 29.7	0.75 19.0	1.18 30.0	RZD/RZU 16	RH 16	
HZ 1180M A	42.34 1075.4	-	37.23 945.6	18.03 458.0	1.37 34.7	1.36 34.7	1.22 31.0	0.79 20.0	1.18 30.0	RZD/RZU 16	RH 16	
HZ 1180M B	42.50 1079.4	-	37.23 945.6	18.03 458.0	1.44 36.7	1.44 36.7	1.30 33.0	0.79 20.0	1.18 30.0	RZD/RZU 16	RH 16	
HZ 1180M C	42.65 1083.4	-	37.23 945.6	18.07 459.0	1.52 38.7	1.52 38.7	1.38 35.0	0.83 21.0	1.18 30.0	RZD/RZU 18	RH 20	
HZ 1180M D	42.81 1087.4	-	37.23 945.6	18.11 460.0	1.60 40.7	1.60 40.7	1.46 37.0	0.87 22.0	1.18 30.0	RZD/RZU 18	RH 20	

HZ[®]-M STEEL WALL SYSTEMS

Solution 100

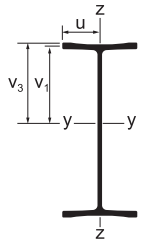

SECTION	PROPERTIES PER SOLUTION												Coating Area	
	Dimensions					Sectional Area in ² cm ²	Mass lb/ft kg/m	Moment of Inertia		Elastic Section Modulus			Waterside ft ² /ft m ² /m	Landside ft ² /ft m ² /m
	v ₁ in mm	v ₂ in mm	v ₃ in mm	v ₄ in mm	u in mm			y-y in ⁴ cm ⁴	z-z in ⁴ cm ⁴	y-y* in ³ cm ³	y-y** in ³ cm ³	z-z in ³ cm ³		
HZ 630M	12.12 307.9	-	12.43 315.7	-	8.27 210.0	48.37 312.0	164.59 244.9	5306.2 220,860	822.2 34,220	437.7 7,175	-	99.4 1,630	1.38 0.421	7.97 2.430
HZ 880M A	15.82 401.7	-	16.36 415.7	-	9.02 229.0	45.82 295.6	155.92 232.0	8571.4 356,770	960.8 39,990	542.0 8,880	-	106.6 1,745	1.51 0.459	9.73 2.966
HZ 880M B	15.89 403.7	-	16.36 415.7	-	9.06 230.0	50.87 328.2	173.13 257.6	9435.7 392,750	1027.5 42,770	593.7 9,730	-	113.5 1,860	1.51 0.461	9.74 2.967
HZ 880M C	15.97 405.7	-	16.36 415.7	-	9.06 230.0	53.11 342.7	180.76 269.0	10012.7 416,760	1065.5 44,350	626.9 10,275	-	117.7 1,930	1.51 0.461	9.73 2.967
HZ 1080M A	20.62 523.7	-	21.17 537.7	-	8.94 227.0	57.63 371.8	196.13 291.9	16805.3 699,490	944.7 39,320	815.1 13,355	-	105.7 1,730	1.49 0.455	11.17 3.403
HZ 1080M B	20.74 526.7	-	21.17 537.7	-	8.94 227.0	61.26 395.2	208.46 310.2	18373.8 764,780	1016.2 42,300	886.1 14,520	-	113.7 1,865	1.49 0.455	11.17 3.403
HZ 1080M C	20.85 529.7	-	21.17 537.7	-	8.98 228.0	67.77 437.2	230.62 343.2	20257.8 843,200	1079.8 44,950	971.4 15,920	-	120.3 1,970	1.50 0.457	11.17 3.405
HZ 1080M D	21.01 533.7	-	21.17 537.7	-	9.00 228.5	73.04 471.2	248.56 369.9	22093.2 919,590	1127.5 46,930	1051.5 17,230	-	125.3 2,055	1.50 0.457	11.17 3.405
HZ 1180M A	21.17 537.7	-	21.17 537.7	-	9.02 229.0	77.26 498.4	262.92 391.3	23479.2 977,280	1151.8 47,940	1109.1 18,175	-	127.8 2,095	1.50 0.458	11.18 3.406
HZ 1180M B	21.25 539.7	-	21.25 539.7	-	9.02 229.0	80.09 516.7	272.57 405.6	24755.0 1,030,390	1228.6 51,140	1165.1 19,090	-	136.3 2,235	1.50 0.458	11.20 3.414
HZ 1180M C	21.33 541.7	-	21.33 541.7	-	9.04 229.5	84.61 545.9	287.95 428.5	26296.4 1,094,540	1314.5 54,720	1233.0 20,205	-	145.5 2,385	1.51 0.459	11.23 3.423
HZ 1180M D	21.41 543.7	-	21.41 543.7	-	9.06 230.0	89.14 575.1	303.37 451.5	27852.9 1,159,330	1401.5 58,340	1301.2 21,325	-	154.8 2,535	1.53 0.466	11.24 3.426

* Referring outside of HZ[®]-M-flange. ** Referring outside of connector.

HZ[®]-M STEEL WALL SYSTEMS

Solution 102

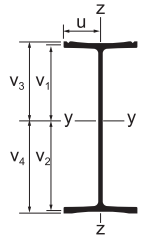

SECTION	PROPERTIES PER SOLUTION													
	Dimensions					Sectional Area in ² cm ²	Mass lb/ft kg/m	Moment of Inertia		Elastic Section Modulus			Coating Area	
	v ₁ in mm	v ₂ in mm	v ₃ in mm	v ₄ in mm	u in mm			y-y in ⁴ cm ⁴	z-z in ⁴ cm ⁴	y-y* in ³ cm ³	y-y** in ³ cm ³	z-z in ³ cm ³	Waterside ft ² /ft m ² /m	Landside ft ² /ft m ² /m
HZ 630M	12.26 311.4	11.98 304.4	12.57 319.2	12.29 312.2	8.27 210.0	47.83 308.6	162.77 242.2	5224.5 217,460	793.1 33010	426.2 6,985	-	95.9 1,570	1.44 0.440	7.97 2.430
HZ 880M A	15.99 406.2	15.64 397.2	16.54 420.1	16.19 411.2	9.02 229.0	45.32 292.4	154.24 229.5	8441.1 351,350	928.4 38640	527.9 8,650	-	103.0 1,685	1.57 0.478	9.73 2.966
HZ 880M B	16.07 408.1	15.72 399.3	16.54 420.0	16.19 411.3	9.06 230.0	50.33 324.7	171.30 254.9	9293.2 386,810	991.9 41280	578.4 9,480	-	109.5 1,795	1.58 0.481	9.74 2.967
HZ 880M C	16.14 409.9	15.81 401.5	16.53 419.9	16.20 411.4	9.06 230.0	52.58 339.2	178.93 266.3	9870.3 410,830	1029.8 42870	611.6 10,025	-	113.7 1,865	1.58 0.480	9.73 2.967
HZ 1080M A	20.80 528.2	20.44 519.2	21.34 542.2	20.99 533.1	8.94 227.0	57.15 368.7	194.49 289.4	16590.8 690,560	913.4 38020	797.8 13,075	-	102.2 1,675	1.55 0.473	11.17 3.403
HZ 1080M B	20.92 531.4	20.55 522.0	21.35 542.4	20.98 532.9	8.94 227.0	60.72 391.7	206.63 307.5	18134.7 754,830	981.6 40860	866.8 14,205	-	109.8 1,800	1.56 0.475	11.17 3.403
HZ 1080M C	21.02 534.0	20.69 525.4	21.34 541.9	21.00 533.4	8.98 228.0	67.23 433.7	228.79 340.5	20018.9 833,250	1044.9 43490	952.3 15,605	-	116.4 1,910	1.56 0.476	11.17 3.405
HZ 1080M D	21.17 537.7	20.86 529.7	21.32 541.6	21.01 533.7	9.00 228.5	72.50 467.7	246.73 367.2	21854.4 909,650	1092.3 45470	1032.5 16,920	-	121.4 1,990	1.56 0.477	11.17 3.405
HZ 1180M A	21.32 541.5	21.02 533.9	21.32 541.5	21.02 533.9	9.02 229.0	76.72 494.9	261.08 388.5	23238.6 967,270	1116.2 46460	1090.1 17,865	-	123.8 2,030	1.57 0.477	11.18 3.406
HZ 1180M B	21.44 544.5	21.06 534.9	21.44 544.5	21.06 534.9	9.02 229.0	79.37 512.1	270.13 402.0	24433.5 1,017,000	1181.4 49170	1139.7 18,675	-	131.0 2,145	1.58 0.481	11.20 3.414
HZ 1180M C	21.51 546.3	21.15 537.1	21.51 546.3	21.15 537.1	9.04 229.5	83.89 541.2	285.51 424.9	25972.6 1,081,070	1267.1 52740	1207.6 19,790	-	140.2 2,300	1.58 0.482	11.23 3.423
HZ 1180M D	21.67 550.4	21.14 537.0	21.67 550.4	21.14 537.0	9.06 230.0	88.05 568.1	299.66 445.9	27355.6 1,138,630	1329.5 55340	1262.5 20,690	-	146.8 2,405	1.60 0.487	11.24 3.426

* Referring outside of HZ[®]-M-flange. ** Referring outside of connector.

HZ[®]-M STEEL WALL SYSTEMS

Solution 104

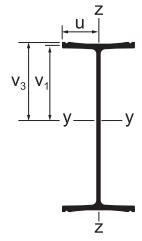

SECTION	PROPERTIES PER SOLUTION													
	Dimensions					Sectional Area in ² cm ²	Mass lb/ft kg/m	Moment of Inertia		Elastic Section Modulus			Coating Area	
	v ₁ in mm	v ₂ in mm	v ₃ in mm	v ₄ in mm	u in mm			y-y in ⁴ cm ⁴	z-z in ⁴ cm ⁴	y-y* in ³ cm ³	y-y** in ³ cm ³	z-z in ³ cm ³	Waterside ft ² /ft m ² /m	Landside ft ² /ft m ² /m
HZ 630M	12.12 307.9	12.12 307.9	12.43 315.7	12.43 315.7	8.27 210.0	47.29 305.1	160.94 239.5	5144.6 214,130	764.0 31800	424.4 6,955	-	92.4 1,515	1.44 0.440	8.04 2.449
HZ 880M A	15.82 401.7	15.82 401.7	16.36 415.7	16.36 415.7	9.02 229.0	44.83 289.2	152.57 227.0	8313.6 346,040	895.9 37290	525.7 8,615	-	99.4 1,630	1.57 0.478	9.79 2.984
HZ 880M B	15.89 403.7	15.89 403.7	16.36 415.7	16.36 415.7	9.06 230.0	49.80 321.3	169.47 252.2	9153.7 381,010	956.2 39800	575.9 9,440	-	105.6 1,730	1.58 0.481	9.80 2.987
HZ 880M C	15.97 405.7	15.97 405.7	16.36 415.7	16.36 415.7	9.06 230.0	52.04 335.7	177.10 263.6	9730.7 405,030	994.2 41380	609.2 9,985	-	109.8 1,800	1.58 0.480	9.80 2.987
HZ 1080M A	20.62 523.7	20.62 523.7	21.17 537.7	21.17 537.7	8.94 227.0	56.67 365.6	192.84 287.0	16379.9 681,790	882.1 36720	794.4 13,020	-	98.7 1,620	1.55 0.473	11.23 3.421
HZ 1080M B	20.74 526.7	20.74 526.7	21.17 537.7	21.17 537.7	8.94 227.0	60.18 388.3	204.80 304.8	17899.8 745,050	947.0 39420	863.2 14,145	-	106.0 1,735	1.56 0.475	11.23 3.423
HZ 1080M C	20.85 529.7	20.85 529.7	21.17 537.7	21.17 537.7	8.98 228.0	66.69 430.3	226.96 337.8	19783.7 823,460	1009.9 42040	948.7 15,545	-	112.5 1,845	1.56 0.476	11.23 3.424
HZ 1080M D	21.01 533.7	21.01 533.7	21.17 537.7	21.17 537.7	9.00 228.5	71.96 464.3	244.90 364.4	21619.1 899,860	1057.2 44000	1028.9 16,860	-	117.5 1,925	1.56 0.477	11.24 3.425
HZ 1180M A	21.17 537.7	21.17 537.7	21.17 537.7	21.17 537.7	9.02 229.0	76.17 491.4	259.23 385.8	23001.4 957,390	1080.6 44980	1086.6 17,805	-	119.9 1,965	1.57 0.477	11.24 3.426
HZ 1180M B	21.25 539.7	21.25 539.7	21.25 539.7	21.25 539.7	9.02 229.0	78.66 507.5	267.68 398.4	24117.8 1,003,860	1134.2 47210	1135.1 18,600	-	125.8 2,060	1.58 0.481	11.28 3.437
HZ 1180M C	21.33 541.7	21.33 541.7	21.33 541.7	21.33 541.7	9.04 229.5	83.17 536.6	283.06 421.2	25654.4 1,067,820	1219.6 50760	1202.9 19,710	-	135.0 2,210	1.58 0.482	11.31 3.446
HZ 1180M D	21.41 543.7	21.41 543.7	21.41 543.7	21.41 543.7	9.06 230.0	86.96 561.0	295.94 440.4	26870.5 1,118,440	1257.5 52340	1255.3 20,570	-	138.9 2,275	1.60 0.487	11.31 3.447

* Referring outside of HZ[®]-M-flange. ** Referring outside of connector.

HZ[®]-M STEEL WALL SYSTEMS

Solution 12

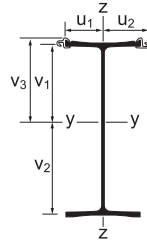

Delivery Form

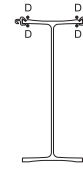

D = discontinuous weld, a = 0.236" (6 mm), 10% of length (3.94" per 3.28', 100 mm/m) over the whole pile length + 19.68" (500 mm) continuous weld at top and toe

R = continuous weld, a = 0.236" (6 mm), length 19.68" (500 mm) at top and toe only

SECTION	PROPERTIES PER SOLUTION														
	Dimensions						Sectional Area in ² cm ²	Mass lb/ft kg/m	Moment of Inertia		Elastic Section Modulus			Coating Area	
	V ₁ in mm	V ₂ in mm	V ₃ in mm	V ₄ in mm	U ₁ in mm	U ₂ in mm			y-y in ⁴ cm ⁴	z-z in ⁴ cm ⁴	y-y* in ³ cm ³	y-y** in ³ cm ³	z-z in ³ cm ³	Waterside ft ² /ft m ² /m	Landside ft ² /ft m ² /m
HZ 630M	10.85 275.5	13.39 340.2	11.96 303.8	-	8.26 209.9	10.39 263.9	54.20 349.7	184.45 274.5	6036.6 251,260	1282.9 53400	450.7 7,385	504.8 8270	123.5 2,025	1.91 0.582	8.29 2.527
HZ 880M A	14.02 356.2	17.61 447.2	15.37 390.5	-	9.01 228.9	11.14 282.9	51.70 333.5	175.93 261.8	9868.8 410,770	1504.9 62640	560.5 9,185	641.9 10520	135.1 2,215	2.04 0.621	9.90 3.017
HZ 880M B	14.27 362.5	17.51 444.9	15.55 394.9	-	9.05 229.9	11.18 283.9	56.71 365.8	192.98 287.2	10738.1 446,960	1573.2 65480	613.1 10,045	690.8 11320	140.8 2,305	2.05 0.624	9.91 3.019
HZ 880M C	14.41 366.1	17.53 445.3	15.61 396.4	-	9.05 229.9	11.18 283.9	58.95 380.3	200.61 298.5	11320.8 471,210	1611.2 67060	645.7 10,580	725.3 11885	144.2 2,360	2.05 0.624	9.90 3.019
HZ 1080M A	18.72 475.6	22.51 571.8	20.07 509.9	-	8.93 226.9	11.06 280.9	63.52 409.8	216.17 321.7	19067.5 793,650	1480.5 61620	846.9 13,880	949.9 15565	133.9 2,195	2.02 0.617	11.34 3.455
HZ 1080M B	18.96 481.5	22.51 571.9	20.19 512.9	-	8.93 226.9	11.06 280.9	67.09 432.8	228.32 339.8	20628.1 858,610	1548.7 64460	916.2 15,015	1021.7 16740	140.1 2,295	2.03 0.618	11.33 3.455
HZ 1080M C	19.23 488.5	22.48 570.9	20.35 516.8	-	8.97 227.9	11.10 281.9	73.60 474.8	250.48 372.8	22531.1 937,820	1616.7 67290	1002.5 16,430	1107.3 18145	145.7 2,385	2.03 0.619	11.34 3.456
HZ 1080M D	19.50 495.3	22.53 572.1	20.46 519.6	-	8.99 228.4	11.12 282.4	78.87 508.8	268.41 399.4	24379.5 1,014,760	1666.5 69370	1082.3 17,735	1191.9 19530	149.9 2,455	2.03 0.620	11.34 3.457
HZ 1180M A	19.73 501.2	22.61 574.2	20.53 521.5	-	9.01 228.9	11.14 282.9	83.09 536.0	282.76 420.8	25773.1 1,072,760	1692.8 70460	1140.1 18,685	1255.2 20570	152.0 2,490	2.04 0.621	11.34 3.458
HZ 1180M B	19.89 505.3	22.60 574.1	20.61 523.6	-	9.01 228.9	11.14 282.9	85.75 553.2	291.81 434.3	26985.0 1,123,200	1758.2 73180	1193.9 19,565	1309.0 21450	157.9 2,585	2.04 0.622	11.36 3.462
HZ 1180M C	19.90 505.4	22.76 578.0	20.66 524.7	-	9.03 229.4	11.16 283.4	90.96 586.8	309.55 460.7	28778.5 1,197,860	1897.2 78970	1264.6 20,725	1393.2 22830	170.1 2,785	2.08 0.635	11.39 3.471
HZ 1180M D	20.13 511.2	22.68 576.2	20.81 528.5	-	9.05 229.9	11.18 283.9	95.12 613.7	323.70 481.7	30194.1 1,256,780	1962.2 81670	1331.1 21,815	1451.1 23780	175.6 2,875	2.10 0.641	11.40 3.476

* Referring outside of HZ[®]-M-flange. ** Referring outside of connector.

HZ[®]-M STEEL WALL SYSTEMS

Solution 14

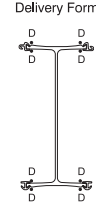
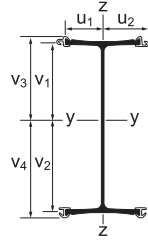

D = discontinuous weld, a = 0.236" (6 mm), 10% of length (3.94" per 3.28', 100 mm/m) over the whole pile length + 19.68" (500 mm) continuous weld at top and toe

R = continuous weld, a = 0.236" (6 mm), length 19.68" (500 mm) at top and toe only

SECTION	PROPERTIES PER SOLUTION														
	Dimensions						Sectional Area in ² cm ²	Mass lb/ft kg/m	Moment of Inertia		Elastic Section Modulus			Coating Area	
	V ₁ in mm	V ₂ in mm	V ₃ in mm	V ₄ in mm	U ₁ in mm	U ₂ in mm			y-y in ⁴ cm ⁴	z-z in ⁴ cm ⁴	y-y* in ³ cm ³	y-y** in ³ cm ³	z-z in ³ cm ³	Waterside ft ² /ft m ² /m	Landside ft ² /ft m ² /m
HZ 630M	12.10 307.5	12.14 308.3	13.22 335.7	13.25 336.6	8.26 209.9	10.39 263.9	59.90 386.5	203.85 303.4	6939.7 288,850	1711.8 71250	571.8 9,370	523.7 8580	164.8 2,700	1.91 0.582	9.21 2.808
HZ 880M A	15.79 401.1	15.84 402.4	17.14 435.4	17.20 436.8	9.01 228.9	11.14 282.9	57.44 370.6	195.49 290.9	11486.0 478,080	2013.6 83810	725.1 11,880	667.9 10945	180.8 2,965	2.04 0.621	10.67 3.253
HZ 880M B	15.87 403.1	15.92 404.3	17.14 435.4	17.19 436.8	9.05 229.9	11.18 283.9	62.41 402.6	212.38 316.1	12326.1 513,050	2083.3 86710	774.4 12,690	716.9 11745	186.4 3,055	2.05 0.624	10.68 3.256
HZ 880M C	15.95 405.1	16.00 406.3	17.14 435.5	17.19 436.7	9.05 229.9	11.18 283.9	64.65 417.1	220.02 327.4	12903.1 537,070	2121.3 88290	806.7 13,220	750.4 12300	189.8 3,110	2.05 0.624	10.68 3.255
HZ 1080M A	20.59 522.9	20.65 524.5	21.94 557.2	22.00 558.9	8.93 226.9	11.06 280.9	69.28 446.9	235.76 350.9	21761.8 905,800	1981.3 82470	1053.9 17,270	989.0 16205	179.2 2,935	2.02 0.617	12.11 3.690
HZ 1080M B	20.71 526.0	20.77 527.4	21.94 557.3	22.00 558.9	8.93 226.9	11.06 280.9	72.79 469.6	247.72 368.6	23281.5 969,050	2046.2 85170	1121.2 18,375	1058.2 17340	185.0 3,030	2.03 0.618	12.11 3.691
HZ 1080M C	20.83 529.0	20.88 530.4	21.94 557.3	22.00 558.8	8.97 227.9	11.10 281.9	79.30 511.6	269.88 401.6	25165.6 1,047,480	2118.4 88170	1205.2 19,750	1143.9 18745	190.9 3,130	2.03 0.619	12.12 3.693
HZ 1080M D	20.99 533.1	21.04 534.3	21.94 557.4	22.00 558.8	8.99 228.4	11.12 282.4	84.57 545.6	287.81 428.3	27001.0 1,123,870	2170.3 90340	1283.5 21,035	1227.4 20115	195.2 3,200	2.03 0.620	12.12 3.693
HZ 1180M A	21.15 537.1	21.19 538.3	21.94 557.4	21.97 558.1	9.01 228.9	11.14 282.9	88.78 572.8	302.15 449.6	28383.2 1,181,400	2198.4 91500	1339.3 21,945	1291.7 21170	197.4 3,235	2.04 0.621	12.12 3.694
HZ 1180M B	21.22 539.1	21.27 540.3	21.95 557.4	22.00 558.7	9.01 228.9	11.14 282.8	91.27 588.8	310.60 462.2	29499.6 1,227,870	2251.9 93730	1386.8 22,725	1341.1 21975	202.2 3,315	2.04 0.622	12.13 3.696
HZ 1180M C	21.49 545.9	21.16 537.5	22.25 565.2	21.92 556.8	9.03 229.4	11.16 283.4	98.07 632.7	333.73 496.7	31982.3 1,331,210	2538.0 105640	1488.0 24,385	1437.2 23550	227.5 3,730	2.08 0.635	12.24 3.730
HZ 1180M D	21.57 547.8	21.25 539.6	22.25 565.1	21.93 556.9	9.05 229.9	11.18 283.9	101.85 657.1	346.61 515.8	33198.4 1,381,830	2581.4 107440	1539.4 25,225	1492.3 24455	231.0 3,785	2.10 0.641	12.26 3.736

* Referring outside of HZ[®]-M-flange. ** Referring outside of connector.

HZ[®]-M STEEL WALL SYSTEMS

Solution 124

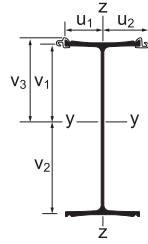

Delivery Form



D = discontinuous weld, a = 0.236" (6 mm), 10% of length (3.94" per 3.28', 100 mm/m) over the whole pile length + 19.68" (500 mm) continuous weld at top and toe

R = continuous weld, a = 0.236" (6 mm), length 19.68" (500 mm) at top and toe only

SECTION	PROPERTIES PER SOLUTION														
	Dimensions						Sectional Area in ² cm ²	Mass lb/ft kg/m	Moment of Inertia		Elastic Section Modulus			Coating Area	
	V ₁ in mm	V ₂ in mm	V ₃ in mm	V ₄ in mm	u ₁ in mm	u ₂ in mm			y-y in ⁴ cm ⁴	z-z in ⁴ cm ⁴	y-y* in ³ cm ³	y-y** in ³ cm ³	z-z in ³ cm ³	Waterside ft ² /ft m ² /m	Landside ft ² /ft m ² /m
HZ 630M	10.71 272.1	13.53 343.6	11.82 300.3	-	8.26 209.9	10.39 263.9	53.66 346.2	182.65 271.8	5931.1 247,130	1252.6 52190	438.6 7,190	502.0 8230	120.8 1,980	0.00 0.582	0.00 2.546
HZ 880M A	13.85 351.8	17.78 451.6	15.20 386.1	-	9.01 228.8	11.14 282.9	51.20 330.3	174.25 259.3	9698.2 404,090	1471.0 61290	546.0 8,950	638.4 10465	132.1 2,165	0.00 0.621	0.00 3.035
HZ 880M B	14.10 358.2	17.69 449.2	15.37 390.5	-	9.05 229.9	11.18 283.9	56.17 362.4	191.18 284.5	10554.7 439,780	1536.0 64000	597.2 9,790	686.9 11260	137.6 2,255	0.00 0.624	0.00 3.039
HZ 880M C	14.25 361.9	17.70 449.5	15.44 392.3	-	9.05 229.9	11.18 283.9	58.40 376.8	198.78 295.8	11138.2 464,090	1573.9 65580	629.8 10,325	721.6 11830	140.9 2,310	0.00 0.624	0.00 3.038
HZ 1080M A	18.54 470.8	22.70 576.6	19.89 505.1	-	8.93 226.9	11.06 280.9	63.04 406.7	214.57 319.3	18793.0 783,040	1447.7 60320	828.4 13,580	945.5 15500	131.2 2,150	0.00 0.617	0.00 3.473
HZ 1080M B	18.76 476.6	22.71 576.8	20.00 507.9	-	8.93 226.9	11.06 280.9	66.56 429.4	226.46 337.0	20325.6 846,900	1512.5 63020	895.8 14,685	1017.2 16675	136.9 2,245	0.00 0.618	0.00 3.474
HZ 1080M C	19.06 484.1	22.65 575.3	20.17 512.4	-	8.97 227.9	11.10 281.9	73.07 471.4	248.64 370.0	22230.7 926,280	1580.2 65840	982.1 16,100	1102.9 18080	142.4 2,335	0.00 0.619	0.00 3.476
HZ 1080M D	19.34 491.2	22.69 576.3	20.30 515.5	-	8.99 228.4	11.12 282.4	78.34 505.4	266.58 396.7	24079.9 1,003,330	1629.6 67900	1062.0 17,410	1187.4 19465	146.7 2,405	0.00 0.620	0.00 3.476
HZ 1180M A	19.58 497.3	22.76 578.1	20.38 517.6	-	9.01 228.9	11.14 282.9	82.55 532.6	280.96 418.1	25471.9 1,061,330	1655.5 68980	1120.0 18,360	1250.8 20505	148.8 2,440	0.00 0.621	0.00 3.477
HZ 1180M B	19.70 500.5	22.79 578.9	20.43 518.8	-	9.01 228.9	11.14 282.9	85.03 548.6	289.36 430.6	26593.2 1,108,050	1709.0 71210	1167.5 19,140	1303.0 21360	153.4 2,515	0.00 0.622	0.00 3.484
HZ 1180M C	19.72 500.8	22.94 582.6	20.48 520.1	-	9.03 229.4	11.16 283.4	90.24 582.2	307.10 457.0	28380.2 1,182,510	1847.8 76990	1238.3 20,300	1386.8 22735	165.6 2,715	0.00 0.635	0.00 3.493
HZ 1180M D	19.86 504.5	22.95 582.9	20.54 521.8	-	9.05 229.9	11.18 283.9	94.02 606.6	320.01 476.2	29604.2 1,233,510	1888.3 78680	1290.8 21,160	1442.0 23640	169.0 2,770	0.00 0.641	0.00 3.497

* Referring outside of HZ[®]-M-flange. ** Referring outside of connector.

HZ[®]-M STEEL WALL SYSTEMS

Solution 24

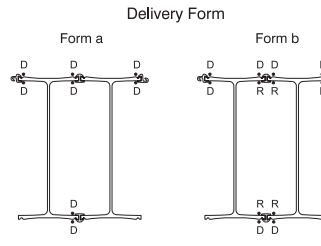
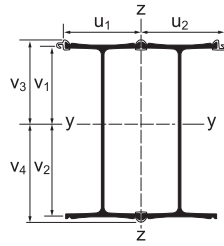

D = discontinuous weld, a = 0.236" (6 mm), 10% of length (3.94" per 3.28', 100 mm/m) over the whole pile length + 19.68" (500 mm) continuous weld at top and toe

R = continuous weld, a = 0.236" (6 mm), length 19.68" (500 mm) at top and toe only

SECTION	PROPERTIES PER SOLUTION														
	Dimensions						Sectional Area in ² cm ²	Mass lb/ft kg/m	Moment of Inertia		Elastic Section Modulus			Coating Area	
	V ₁ in mm	V ₂ in mm	V ₃ in mm	V ₄ in mm	u ₁ in mm	u ₂ in mm			y-y in ⁴ cm ⁴	z-z in ⁴ cm ⁴	y-y* in ³ cm ³	y-y** in ³ cm ³	z-z in ³ cm ³	Waterside ft ² /ft m ² /m	Landside ft ² /ft m ² /m
HZ 630M	11.42 290.0	12.83 325.8	12.53 318.3	13.94 354.1	16.81 426.9	18.93 480.9	107.19 691.5	364.79 542.9	12031.0 500,770	10338.8 430330	938.1 15,370	863.0 14140	546.1 8,950	3.50 1.067	9.94 3.031
HZ 880M A	14.83 376.7	16.80 426.7	16.19 411.2	18.16 461.2	18.30 464.8	20.43 518.9	102.27 659.8	348.05 518.0	19700.6 820,000	11783.3 490460	1172.7 19,220	1217.0 19945	576.8 9,450	3.75 1.144	11.68 3.559
HZ 880M B	15.00 380.9	16.79 426.5	16.27 413.4	18.07 458.9	18.38 466.9	20.51 520.9	112.20 723.9	381.85 568.3	21389.6 890,310	12853.1 534990	1273.9 20,875	1314.3 21540	626.7 10,270	3.77 1.150	11.70 3.565
HZ 880M C	15.11 383.8	16.83 427.6	16.31 414.3	18.03 458.1	18.38 466.9	20.51 520.9	116.69 752.8	397.12 591.0	22547.1 938,480	13319.6 554410	1339.3 21,950	1382.5 22655	649.5 10,645	3.77 1.150	11.69 3.565
HZ 1080M A	19.58 497.2	21.66 550.2	20.93 531.7	23.02 584.6	18.14 460.9	20.27 514.9	125.94 812.5	428.61 637.8	38005.0 1,581,890	13596.5 565930	1754.6 28,755	1815.7 29755	670.7 10,990	3.73 1.136	13.10 3.992
HZ 1080M B	19.75 501.6	21.72 551.8	20.99 533.1	22.96 583.2	18.14 460.9	20.27 514.9	132.97 857.9	452.52 673.4	41051.9 1,708,720	14322.7 596160	1889.8 30,970	1956.2 32055	706.6 11,580	3.73 1.138	13.11 3.995
HZ 1080M C	19.96 506.9	21.75 552.5	21.07 535.3	22.87 581.0	18.22 462.9	20.35 516.9	145.99 941.9	496.84 739.4	44831.4 1,866,030	15669.5 652220	2060.9 33,770	2127.3 34860	770.1 12,620	3.74 1.141	13.12 3.998
HZ 1080M D	20.17 512.4	21.85 555.0	21.14 536.8	22.81 579.4	18.26 463.9	20.39 517.9	156.53 1009.9	532.71 792.8	48510.1 2,019,150	16728.2 696280	2220.2 36,380	2295.3 37615	820.5 13,445	3.75 1.142	13.12 3.999
HZ 1180M A	20.37 517.5	21.97 557.9	21.18 537.9	22.77 578.3	18.30 464.9	20.43 518.9	164.96 1064.2	561.38 835.4	51280.2 2,134,450	17564.3 731080	2334.7 38,260	2421.5 39680	859.9 14,090	3.75 1.144	13.13 4.001
HZ 1180M B	20.48 520.1	22.02 559.3	21.20 538.5	22.75 577.7	18.30 464.9	20.43 518.9	169.92 1096.3	578.28 860.6	53516.1 2,227,520	18099.9 753380	2430.4 39,825	2524.3 41365	886.1 14,520	3.76 1.147	13.15 4.009
HZ 1180M C	20.53 521.3	22.13 562.1	21.29 540.6	22.89 581.4	18.38 466.9	20.51 520.9	181.24 1169.3	616.79 917.9	57523.0 2,394,300	19477.8 810730	2599.6 42,600	2702.5 44285	949.8 15,565	3.82 1.164	13.20 4.022
HZ 1180M D	20.64 524.2	22.17 563.2	21.32 541.5	22.86 580.5	18.42 467.9	20.55 521.9	188.81 1218.1	642.55 956.2	59959.8 2,495,730	20289.8 844530	2704.0 44,310	2812.7 46095	987.5 16,180	3.86 1.176	13.23 4.032

* Referring outside of HZ[®]-M-flange. ** Referring outside of connector.

HZ[®]-M STEEL WALL SYSTEMS

Solution 26

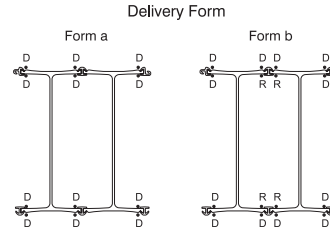
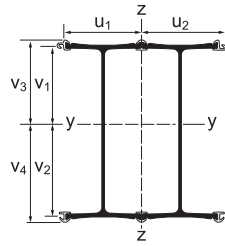

D = discontinuous weld, a = 0.236" (6 mm), 10% of length (3.94" per 3.28', 100 mm/m) over the whole pile length + 19.68" (500 mm) continuous weld at top and toe

R = continuous weld, a = 0.236" (6 mm), length 19.68" (500 mm) at top and toe only

SECTION	PROPERTIES PER SOLUTION														
	Dimensions						Sectional Area in ² cm ²	Mass lb/ft kg/m	Moment of Inertia		Elastic Section Modulus			Coating Area	
	V ₁ in mm	V ₂ in mm	V ₃ in mm	V ₄ in mm	u ₁ in mm	u ₂ in mm			y-y in ⁴ cm ⁴	z-z in ⁴ cm ⁴	y-y* in ³ cm ³	y-y** in ³ cm ³	z-z in ³ cm ³	Waterside ft ² /ft m ² /m	Landside ft ² /ft m ² /m
HZ 630M	12.11 307.6	12.13 308.1	13.23 336.0	13.24 336.4	16.81 426.9	18.93 480.9	113.43 731.8	386.02 574.5	12980.3 540,280	12162.8 506260	1070.2 17,535	980.1 16060	642.4 10,530	3.50 1.067	10.80 3.292
HZ 880M A	15.80 401.4	15.83 402.0	17.16 435.8	17.19 436.5	18.31 464.9	20.43 518.8	108.51 700.1	369.28 549.6	21379.6 889,890	13940.2 580240	1350.7 22,135	1246.1 20420	682.5 11,185	3.75 1.144	12.39 3.776
HZ 880M B	15.88 403.4	15.91 404.0	17.16 435.8	17.18 436.5	18.38 467.0	20.50 520.8	118.44 764.1	403.08 599.9	23059.8 959,830	15028.4 625530	1449.8 23,755	1343.9 22020	733.0 12,010	3.77 1.150	12.41 3.782
HZ 880M C	15.96 405.4	15.98 406.0	17.16 435.9	17.18 436.5	18.38 467.0	20.50 520.8	122.93 793.1	418.35 622.6	24213.8 1,007,860	15494.9 644950	1514.9 24,825	1411.1 23125	755.7 12,385	3.77 1.150	12.41 3.782
HZ 1080M A	20.60 523.3	20.63 524.1	21.96 557.7	21.99 558.5	18.14 460.9	20.27 514.9	132.18 852.8	449.84 669.4	40817.8 1,698,970	15717.1 654200	1978.2 32,415	1859.0 30465	775.4 12,705	3.73 1.136	13.81 4.209
HZ 1080M B	20.72 526.3	20.75 527.1	21.96 557.7	21.99 558.5	18.14 460.9	20.27 514.9	139.21 898.1	473.75 705.0	43857.5 1,825,490	16443.3 684420	2113.5 34,635	1997.4 32730	811.2 13,295	3.73 1.138	13.82 4.212
HZ 1080M C	20.84 529.4	20.87 530.1	21.96 557.8	21.99 558.5	18.22 462.9	20.35 516.9	152.23 982.1	518.07 771.0	47625.5 1,982,330	17808.3 741240	2282.2 37,400	2168.8 35540	875.2 14,340	3.74 1.141	13.83 4.215
HZ 1080M D	21.00 533.4	21.02 534.0	21.96 557.8	21.99 558.5	18.26 463.9	20.39 517.9	162.77 1050.1	553.94 824.4	51296.2 2,135,120	18876.0 785680	2439.8 39,980	2335.9 38280	925.9 15,170	3.75 1.142	13.83 4.216
HZ 1180M A	21.16 537.4	21.18 538.0	21.96 557.8	21.99 558.4	18.30 464.9	20.43 518.9	171.20 1104.5	582.61 867.0	54060.7 2,250,190	19721.2 820860	2552.3 41,825	2461.7 40340	965.4 15,820	3.75 1.144	13.84 4.217
HZ 1180M B	21.24 539.4	21.26 540.0	21.96 557.8	21.99 558.4	18.30 464.9	20.43 518.8	176.16 1136.5	599.51 892.2	56293.6 2,343,130	20256.9 843160	2647.9 43,390	2563.3 42005	991.7 16,250	3.76 1.147	13.85 4.221
HZ 1180M C	21.41 543.9	21.24 539.5	22.17 563.2	22.00 558.8	18.38 466.9	20.51 520.9	189.07 1219.8	643.42 957.5	60979.6 2,538,170	22216.2 924710	2847.8 46,665	2750.2 45070	1083.4 17,755	3.82 1.164	13.97 4.259
HZ 1180M D	21.49 545.8	21.32 541.6	22.17 563.1	22.00 558.9	18.42 467.9	20.55 521.9	196.63 1268.6	669.18 995.9	63411.7 2,639,410	23041.8 959080	2951.0 48,360	2860.4 46875	1121.5 18,380	3.86 1.176	14.01 4.271

* Referring outside of HZ[®]-M-flange. ** Referring outside of connector.

Available Steel Grades

AMERICAN			CANADIAN			EUROPEAN		
ASTM	Yield Strength		ASTM	Yield Strength		ASTM	Yield Strength	
	ksi	MPa		ksi	MPa		ksi	MPa
A328	39	270	Grade 260 W	38	260	S240 GP	35	240
A572 Grade 42	42	290	Grade 300 W	43	297	S270 GP	39	270
A572 Grade 50	50	345	Grade 355 W	51	355	S320 GP	46	315
A572 Grade 55	55	380	Grade 400 W	58	400	S355 GP	51	355
A572 Grade 60	60	415				S390 GP	57	390
A572 Grade 65**	65	450				S430 GP	62	430
A690**	50	345				S460 AP**	67	460
A690*	57	390						

* Not available for AZ 48/50/52-700, HZ 1080M C-D, and HZ 1180M A-D. ** Not available for HZ 1180M C-D.

Delivery Conditions & Tolerances

HZ[®]-M & AZ PILES	ASTM A6	EN 10248
Mass	± 2.5%	± 5%
Length	+ 5 in.	- 0 in. ± 200 mm
Height		± 5 mm
Width		± 2%
Width Interlocked		± 3%
Straightness		0.2% of the length
Ends out of Square		± 2% of the width
AZ Pile		
Thickness		≤ 8.5 mm ± 0.5 mm
> 8.5 mm		± 6%
HZ[®]-M Pile		
Thickness		≤ 12.5 mm + 2.0, -1.0 mm
		> 12.5 + 2.5, -1.5 mm

Maximum Rolled Lengths[†]

HZ[®]-M	108.3 ft.	33.0 m	
AZ	101.7 ft.	31.0 m	
RZD/RZU	78.7 ft.	24.0 m	(Length does not restrict wall height)
RH	78.7 ft.	24.0 m	(Length does not restrict wall height)

† Longer lengths may be possible upon request.



PILE CONNECTORS

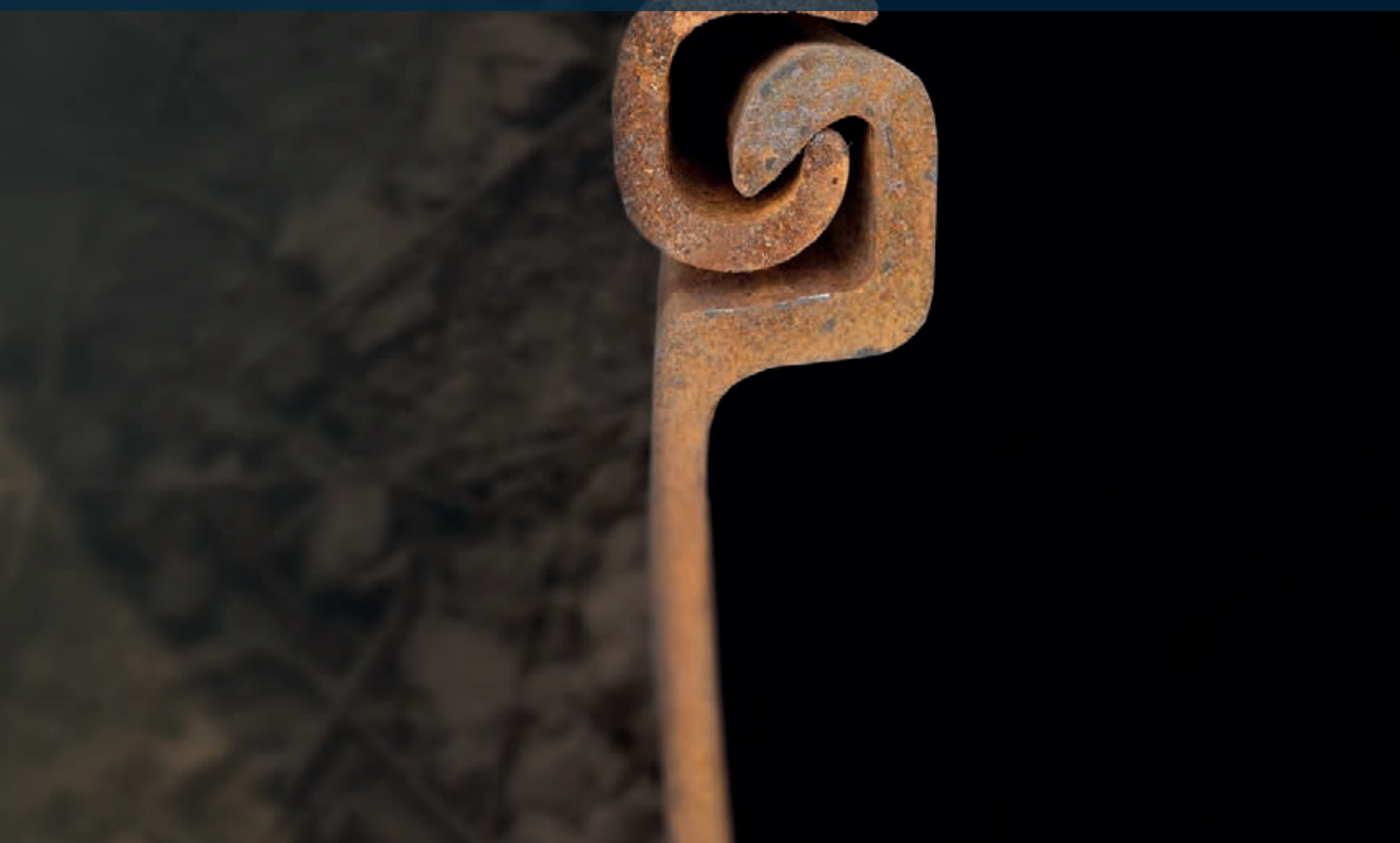

PILE CONNECTORS

LARSENEN

CORNER CONNECTORS

LV20n

For Larssen sheet piles

Steel grade: S355J2
Steel thickness: 0.32" (8 mm)
Standard lengths:
38.7 ft (11.8 m)
45.9 ft (14 m)
59 ft (18 m)
Weight: 9.45 lbs/ft (14.07 kg/m)

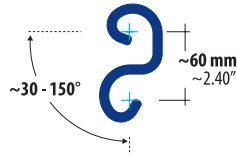

LLS90

For Larssen sheet piles

Steel grade: S355J2
Steel thickness: 0.35" (9 mm)
Standard lengths:
26.25 ft (8 m)
38.7 ft (11.8 m)
Weight: 11.87 lbs/ft (17.66 kg/m)

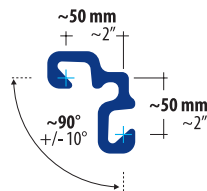

LLS135

For Larssen sheet piles

Steel grade: S355J2
Steel thickness: 0.35" (9 mm)
Standard lengths:
26.25 ft (8 m)
38.7 ft (11.8 m)
59 ft (18 m)
Weight: 11.87 lbs/ft (17.66 kg/m)

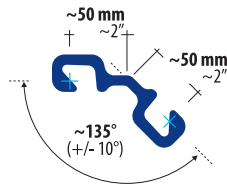

LLS170

For Larssen sheet piles

Steel grade: S355J2
Steel thickness: 0.35" (9 mm)
Standard lengths:
26.25 ft (8 m)
38.7 ft (11.8 m)
59 ft (18 m)
Weight: 11.85 lbs/ft (17.63 kg/m)

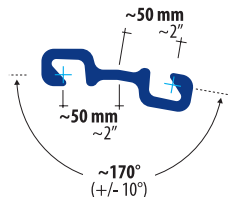

PILE CONNECTORS

LARSEN

OMEGA CORNER CONNECTORS

LVO

For Larssen sheet piles

Steel grade: S355J2
 Steel thickness: 0.32" (8 mm)
 Standard lengths: 38.7 ft (11.8 m),
 45.9 ft (14 m), 59 ft (18 m)
 Weight: 9.3 lbs/ft (13.85 kg/m)

This connector will be modified in 2023 and thereafter enable angular positions of approx. 55°-145° (VL603/AZ18). The modified profile will be called LVOOn.

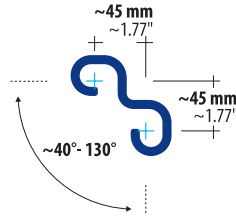

LARSEN

T CONNECTORS

LTn

For Larssen sheet piles

Steel grades: S355J2, S355GP
 Steel thickness: 0.32" (8 mm)
 Standard length S355J2: 38.7 ft (11.8 m)
 Standard length S355GP: 45.2 ft (13.8 m)
 Weight: 10.42 lbs/ft (15.5 kg/m)

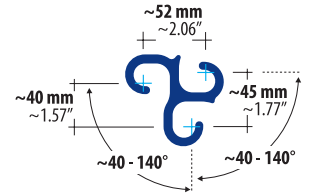

LV-Omega

For Larssen sheet piles

Steel grade: S355J2
 Steel thickness: 0.32" (8 mm)
 Standard lengths: 38.7 ft (11.8 m),
 45.9 ft (14 m), 59 ft (18 m)
 Weight: 9.43 lbs/ft (14.04 kg/m)

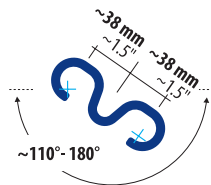

LOTn

For Larssen sheet piles

Steel grades: S355J2, S355GP
 Steel thickness: 0.32" (8 mm)
 Standard length S355J2: 38.7 ft (11.8 m)
 Standard length S355GP: 45.2 ft (13.8 m)
 Weight: 11.56 lbs/ft (17.2 kg/m)

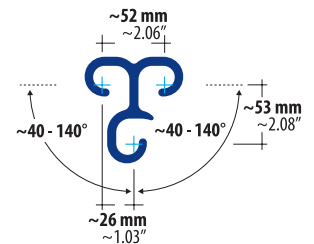

PILE CONNECTORS

LARSEN

CROSS CONNECTOR

L4S

For Larssen sheet piles

Steel grade: S355J2

Steel thickness: 0.32" (8 mm)

Standard length: 38.7 ft (11.8 m)

Weight: 15.6 lbs/ft (23.2 kg/m)

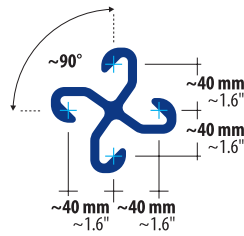

LARSEN

COMBINED WALL CONNECTORS

LV22

Weld-on connector for Larssen sheet piles

Steel grade: S355J2

Steel thickness: 0.32" (8 mm)

Standard length: 38.7 ft (11.8 m)

Weight: 5.39 lbs/ft (8.02 kg/m)

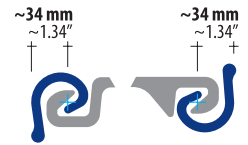

L8

Weld-on connector for Larssen sheet piles

Steel grade: S355J2

Steel thickness: 0.375" (9.5 mm)

Standard length: 38.7 ft (11.8 m)

Weight: 5.69 lbs/ft (8.47 kg/m)

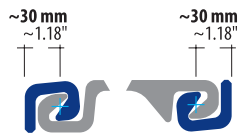

LPB100-9A

Weld-on connector for Larssen sheet piles

Steel grade: S355J2

Steel thickness: 9 mm

Standard lengths: 8 m, 11.8 m

Weight: 9.05 kg/m



PILE CONNECTORS

LARSENEN

PIPE PILE, H-PILE AND COMBINED WALL CONNECTORS

LPB100-10

For Larssen sheet piles

Steel grade: S355J2
 Steel thickness: 0.39" (10 mm)
 Standard lengths:
 26.25 ft (8 m), 38.7 ft (11.8 m)
 Weight: 6.63 lbs/ft (9.86 kg/m)
 Max. tensile strength:
 5.6 kips/in (980 kN/m)

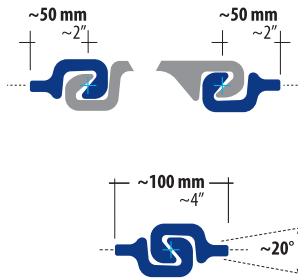

LPB180-16

Not suitable for Larssen sheet piles

Steel grade: S355J2
 Steel thickness: 0.63" (16 mm)
 Standard lengths:
 26.25 ft (8 m), 38.7 ft (11.8 m)
 Weight: 15.05 lbs/ft (22.4 kg/m)
 Max. tensile strength: please see LPB300-16

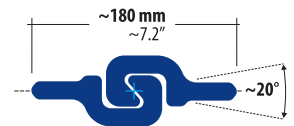

LPB248-12

Not suitable for Larssen sheet piles

Steel grade: S355J2
 Steel thickness: 0.47" (12 mm)
 Standard lengths:
 26.25 ft (8 m), 38.7 ft (11.8 m)
 Weight: 12.27 lbs/ft (18.26 kg/m)
 Max. tensile strength:
 8.57 kips/in (~1,500 kN/m)

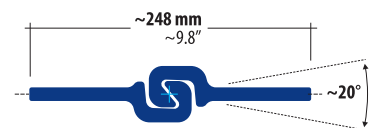

LPB180-10

For Larssen sheet piles

Steel grades: S355J2, S430GP
 Steel thickness: 0.39" (10 mm)
 Standard lengths:
 26.25 ft (8 m), 38.7 ft (11.8 m)
 Weight: 8.7 lbs/ft (12.94 kg/m)
 Max. tensile strength:
 5.86 kips/in (1,026 kN/m)

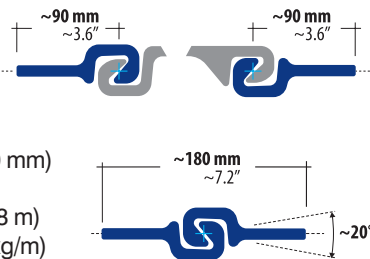

LZ250-12A, LZ250-12B

Not suitable for Larssen sheet piles

Steel grade: S355J2
 Steel thickness: 0.47" (12 mm)
 Standard lengths:
 26.25 ft (8 m), 38.7 ft (11.8 m)
 Weight, each:
 13.1 lbs/ft (19.48 kg/m)
 Max. tensile strength:
 6.85 kips/in (1,200 kN/m)

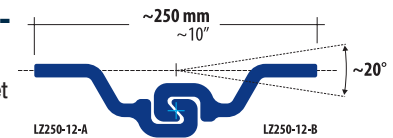

LPB180-12

Not suitable for Larssen sheet piles

Steel grade: S355J2
 Steel thickness: 0.47" (12 mm)
 Standard lengths:
 26.25 ft (8 m), 38.7 ft (11.8 m)
 Weight: 9.74 lbs/ft (14.5 kg/m)
 Max. tensile strength:
 8.58 kips/in (1,502 kN/m)

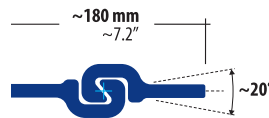

LPB300-16

Not suitable for Larssen sheet piles

Steel grade: S355J2
 Steel thickness: 0.63" (16 mm)
 Standard lengths:
 26.25 ft (8 m), 38.7 ft (11.8 m)
 Weight:
 19.92 lbs/ft (29.65 kg/m)
 Max. tensile strength:
 10.43 kips/in (1,828 kN/m)

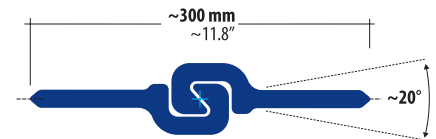

PILE CONNECTORS

MF HIGH TENSILE CONNECTORS

PIPE PILE AND H-PILE WALLS, COMBINED WALLS (BALL+SOCKET)

MF63

Steel grade M35: S355J2, F28: S355J2/-GP
 Steel thickness: 0.47" (12 mm)
 Standard lengths:
 26.25 ft (8 m), 38.7 ft (11.8 m)
 Weight M35: 3.2 lbs/ft (4.76 kg/m)
 Weight F28: 7.19 lbs/ft (10.7 kg/m)
 Max. tensile strength:
 14.57 kips/in (2,552 kN/m), (FEM)

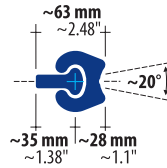

MF100

Steel grade: S355J2
 Steel thickness: 0.47" (12 mm)
 Standard lengths:
 26.25 ft (8 m), 38.7 ft (11.8 m)
 Weight M60: 4.64 lbs/ft (6.9 kg/m)
 Weight F40: 9.6 lbs/ft (14.28 kg/m)
 Max. tensile strength:
 19.52 kips/in (3,419 kN/m)

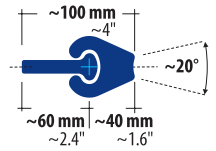

MF75

Steel grade: S355J2
 Steel thickness: 0.47" (12 mm)
 Standard lengths:
 26.25 ft (8 m), 38.7 ft (11.8 m)
 Weight M35: 3.2 lbs/ft (4.76 kg/m)
 Weight F40: 9.6 lbs/ft (14.28 kg/m)
 Max. tensile strength:
 19.52 kips/in (3,419 kN/m)

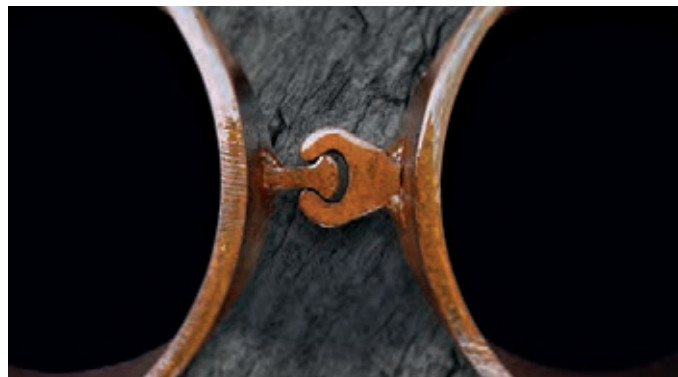
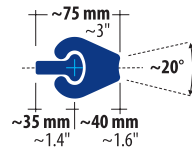

MF130

Steel grade: S355J2
 Steel thickness: 0.47" (12 mm)
 Standard lengths:
 26.25 ft (8 m), 38.7 ft (11.8 m)
 Weight M90: 6.56 lbs/ft (9.76 kg/m)
 Weight F40: 9.6 lbs/ft (14.28 kg/m)
 Max. tensile strength:
 19.52 kips/in (3,419 kN/m)

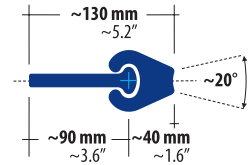

PILE CONNECTORS

MF HIGH TENSILE CONNECTORS

PIPE PILE AND H-PILE WALLS, COMBINED WALLS (BALL+SOCKET)

MF180a

Steel grade: S355J2
 Steel thickness: 0.47" (12 mm)
 Standard lengths:
 26.25 ft (8 m), 38.7 ft (11.8 m)
 Weight M140: 9.92 lbs/ft (14.77 kg/m)
 Weight F40: 9.6 lbs/ft (14.28 kg/m)
 Max. tensile strength:
 19.52 kips/in (3,419 kN/m)

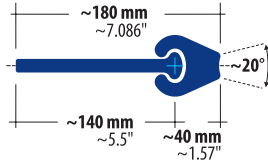

MF230

Steel grade: S355J2
 Steel thickness: 0.47" (12 mm)
 Standard lengths:
 26.25 ft (8 m), 38.7 ft (11.8 m)
 Weight M140: 9.92 lbs/ft (14.77 kg/m)
 Weight F90: 12.377 lbs/ft (18.42 kg/m)
 Max. tensile strength:
 12.15 kips/in (2,128 kN/m)

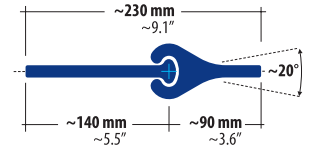

MF180b

Steel grade: S355J2
 Steel thickness: 0.47" (12 mm)
 Standard lengths:
 26.25 ft (8 m), 38.7 ft (11.8 m)
 Weight M90: 6.56 lbs/ft (9.76 kg/m)
 Weight F90: 12.377 lbs/ft (18.42 kg/m)
 Max. tensile strength:
 12.15 kips/in (2,128 kN/m)

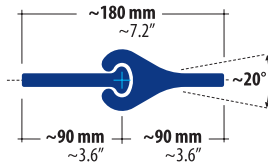

MDF310

Steel grade M140: S355J2
 Steel grade DF: S430GP
 Steel thickness: 0.47" (12 mm)
 Standard lengths:
 26.25 ft (8 m), 38.7 ft (11.8 m)
 Weight M140: 9.92 lbs/ft (14.77 kg/m)
 Weight DF: 9.82 lbs/ft (14.62 kg/m)
 Max. tensile strength: 18.3 kips/in (3,204 kN/m), (FEM)

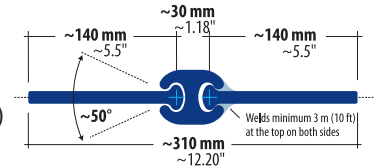

PILE CONNECTORS

MF HIGH TENSILE CONNECTORS FOR DTH DRIVING METHOD

MF64

Steel grade: S355J2
 Steel thickness: 0.47" (12 mm)
 Standard lengths: 26.25 ft (8 m), 38.7 ft (11.8 m)
 Weight M22: 2.3 lbs/ft (3.42 kg/m)
 Weight F40: 9.6 lbs/ft (14.28 kg/m)
 Max. tensile strength:
 19.52 kips/in (3,419 kN/m)
 Exclusively for DTH driving method

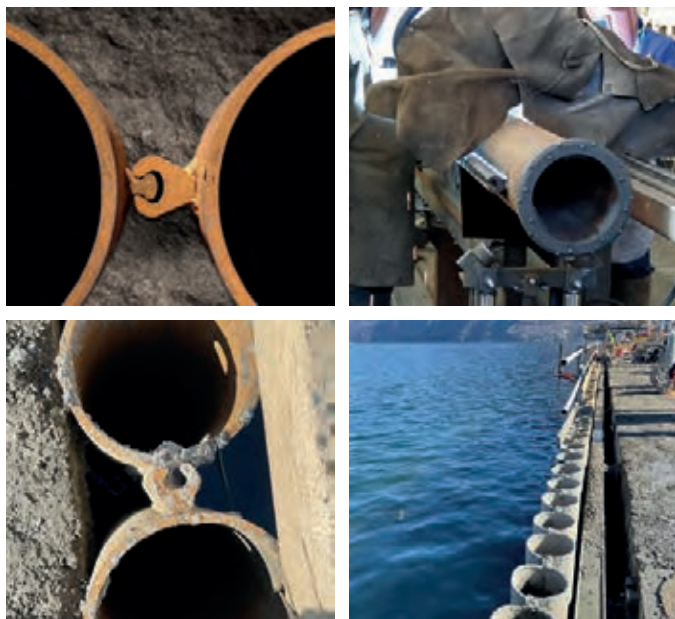
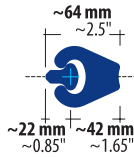

MF64-IC

Steel grade: S355J2
 Steel thickness: 0.39 - 0.47" (10 - 12 mm)
 Standard lengths: 26.25 ft (8 m), 38.7 ft (11.8 m)
 Weight M22: 2.3 lbs/ft (3.42 kg/m)
 Weight F40-IC: 9.1 lbs/ft (13.55 kg/m)
 Max. tensile strength:
 18.08 kips/in (3,167 kN/m)
 Exclusively for DTH driving method

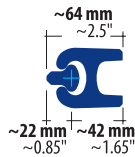

MF64 HIGH TENSILE CONNECTORS COMPARATIVE TENSILE TEST WITH WOM-S/WOF-S

MF64

WOM-S / WOF-S

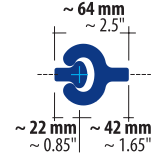
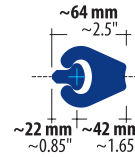

Test setup

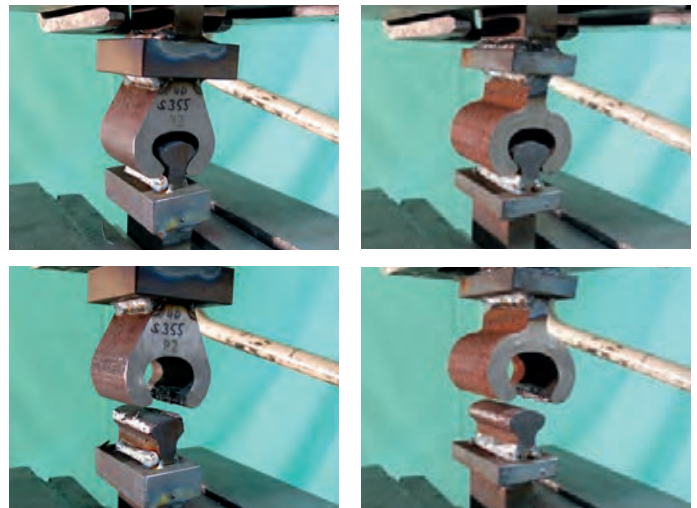

After testing, failure through deformation

Sample no.	Maximum force F_m		Length of the clutch bar		Length-related maximum resilience		
	[kN]	[lb]	[mm]	[in]	[kN/m]	[t/m]	[kip/in]
P1Z1 (WOM-S/WOF-S)	111,97	25,171,83	50,5	1,99	2.217,23	226,09	12,66
P2Z1 (MF64, S355)	168,92	37,974,69	49,4	1,94	3.419,43	348,69	19,53

Conclusion

It is proven that the MF64 connectors can take more than 50% more tensile force than the WOM-S/WOF-S connectors. This is very important information for pipe pile steel wall applications in the DTH driving method.

PILE CONNECTORS

BALL & SOCKET CORNER CONNECTORS

US-90

Steel grades: S355, 572 Grade 50
 Steel thickness: 0.32" (8 mm)
 Standard lengths on request,
 variable from
 25 to 35 ft (7.6 m - 10.6 m)
 Weight: 6.85 lbs/ft (10.1 kg/m)

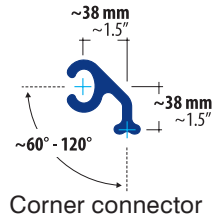

BALL & SOCKET T CONNECTORS

US-TS

Steel grades: S355, 572 Grade 50
 Steel thickness: 0.32" (8 mm)
 Standard lengths on request,
 variable from
 25 to 35 ft (7.6 m - 10.6 m)
 Weight: 11.1 lbs/ft (16.5 kg/m)

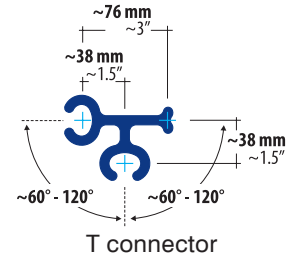

US-135

Steel grades: S355, 572 Grade 50
 Steel thickness: 0.32" (8 mm)
 Standard lengths on request,
 variable from
 25 to 35 ft (7.6 m - 10.6 m)
 Weight: 6.92 lbs/ft (10.3 kg/m)

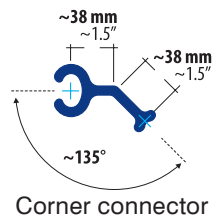

US-T

Steel grades: S355, 572 Grade 50
 Steel thickness: 0.32" (8 mm)
 Standard lengths on request,
 variable from
 25 to 35 ft (7.6 m - 10.6 m)
 Weight: 9 lbs/ft (13.4 kg/m)

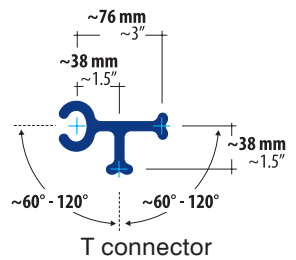

PILE CONNECTORS

BALL & SOCKET

T CONNECTORS

US-Universal

Steel grades: S355, 572 Grade 50
 Steel thickness: 0.32" (8 mm)
 Standard lengths on request,
 variable from
 25 to 35 ft (7.6 m - 10.6 m)
 Weight: 8.33 lbs/ft (12.4 kg/m)

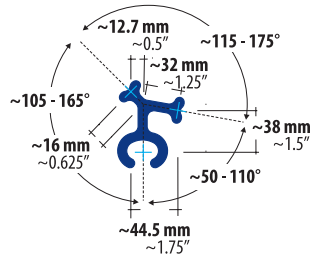

T connector

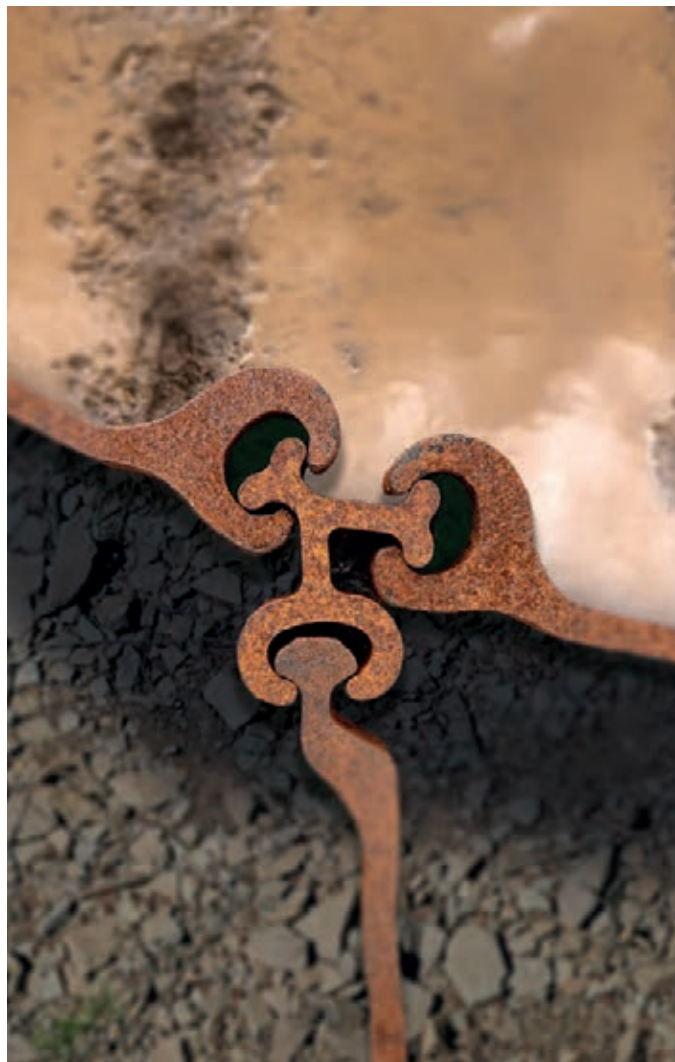

BALL & SOCKET

CROSS CONNECTORS

US-Cross I

Steel grades: S355, 572 Grade 50
 Steel thickness: 0.32" (8 mm)
 Standard lengths on request,
 variable from
 25 to 35 ft (7.6 m - 10.6 m)
 Weight: 13.4 lbs/ft (20 kg/m)

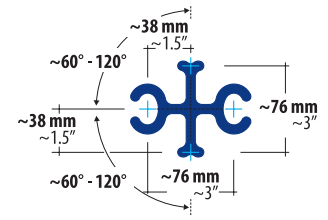

Cross connector



US-Cross II

Steel grades: S355, 572 Grade 50
 Steel thickness: 0.32" (8 mm)
 Standard lengths on request,
 variable from
 25 to 35 ft (7.6 m - 10.6 m)
 Weight: 13.4 lbs/ft (20 kg/m)

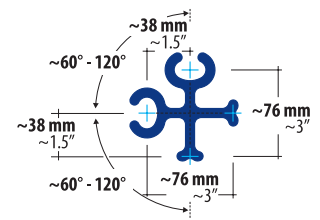

Cross connector



PILE CONNECTORS

FLAT SHEET PILE CONNECTORS

For PS and YSP straight web piles only

FSC60 Center, FSC Leg

Steel grade: S355J2
 Steel thickness FSC60 Center: 0.63" (16 mm)
 Steel thickness FSC Leg: 0.5" (12.7 mm)
 Length FSC60 Center: 31.2 ft (9.5 m)
 Length FSC Leg: up to 59 ft (18 m)
 Weight FSC60 Center:
 20.5 lbs/ft (30.5 kg/m)
 Weight FSC Leg: 13.1 lbs/ft (19.5 kg/m)
 Max. tensile strength FSC60 Center:
 32 kips/in (5,604 kN/m), (FEM)

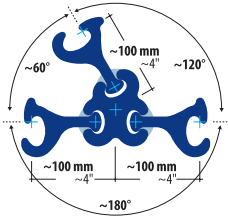

FSC90 Center, FSC Leg

Steel grade: S355J2
 Steel thickness FSC90 Center: 0.63" (16 mm)
 Steel thickness FSC Leg: 0.5" (12.7 mm)
 Length FSC90 Center: 32.8 ft (10 m)
 Length FSC Leg: up to 59 ft (18 m)
 Weight FSC90 Center:
 19.62 lbs/ft (29.2 kg/m)
 Weight FSC Leg: 13.1 lbs/ft (19.5 kg/m)
 Max. tensile strength FSC90 Center:
 35 kips/in (6,129 kN/m), (FEM)

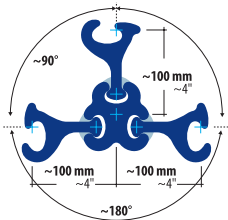

FSC120 Center, FSC Leg

Steel grade: S355J2
 Steel thickness FSC120 Center: 0.63" (16 mm)
 Steel thickness FSC Leg: 0.5" (12.7 mm)
 Length FSC120 Center: 36.8 ft (11.2 m)
 Length FSC Leg: up to 59 ft (18 m)
 Weight FSC120 Center:
 17.67 lbs/ft (26.3 kg/m)
 Weight FSC Leg: 13.1 lbs/ft (19.5 kg/m)
 Max. tensile strength FSC120 Center:
 36 kips/in (6,129 kN/m), (FEM)

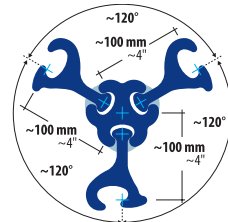

COLD FORMED SHEET PILE CONNECTORS

CF90

Corner connector for midsize cold-formed sheet piles

Steel grade: S355GP
 Steel thickness: 0.32" (8 mm)
 Standard length: 44.1 ft (13.45 m)
 Weight: 11.76 lbs/ft (17.5 kg/m)

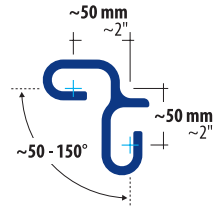

CF-Junction

Weld-on connector for midsize cold-formed sheet piles

Steel grade: S355J2
 Steel thickness: 0.32" (8 mm)
 Standard length: 38.7 ft (11.8 m)
 Weight: 6 lbs/ft (8.87 kg/m)

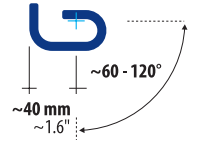

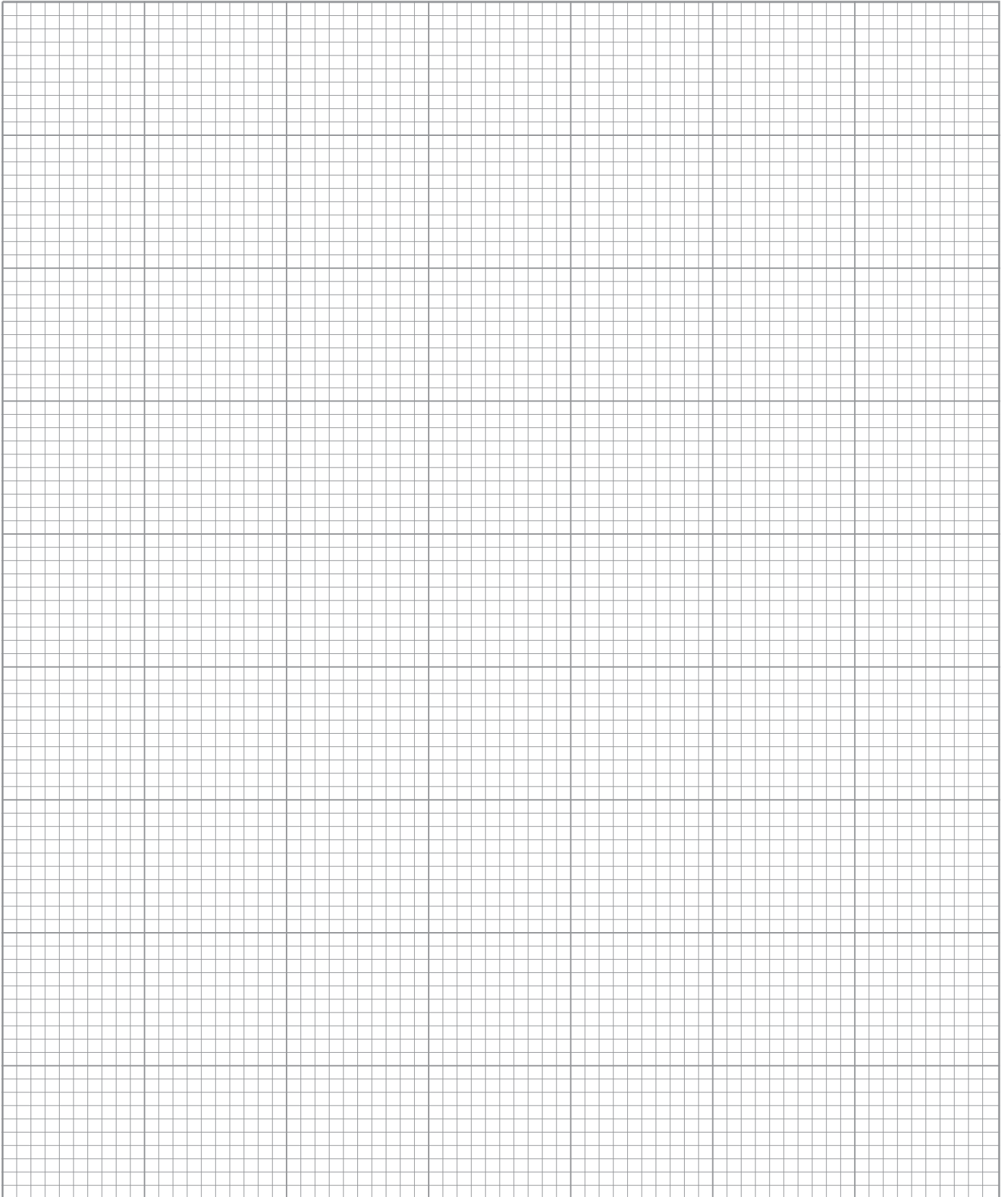



GEOSTRUCTURALS

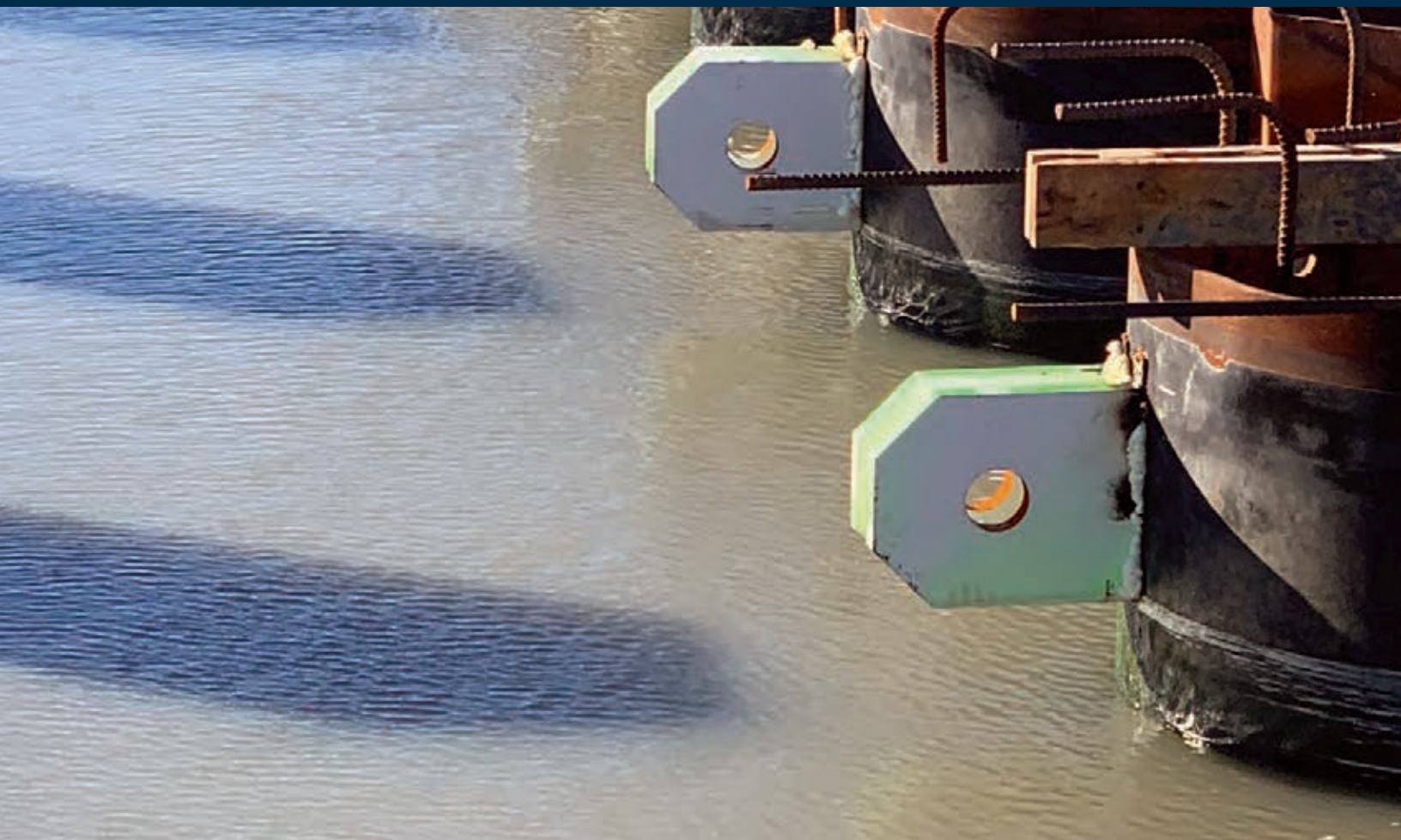

TIE RODS

KEY FEATURES

Tie Rods produced from THREADBAR® are used for marine bulkheads, docking facilities, barge and ship docks as well as offshore platforms. They are a cost effective alternative to large diameter A36 Tie Rods with upset threads.

Continuous, coarse thread allows for rough site handling and for easy on site length adjustments since cutting or coupling of the rod is possible along its entire length.

CORROSION PROTECTION OPTIONS

- Double Corrosion Protection (DCP)
- Hot dip galvanizing
- Epoxy coating
- Tape coating

TIE ROD WITH DOUBLE CORROSION PROTECTION (DCP)

Recommended for permanent applications in aggressive environments

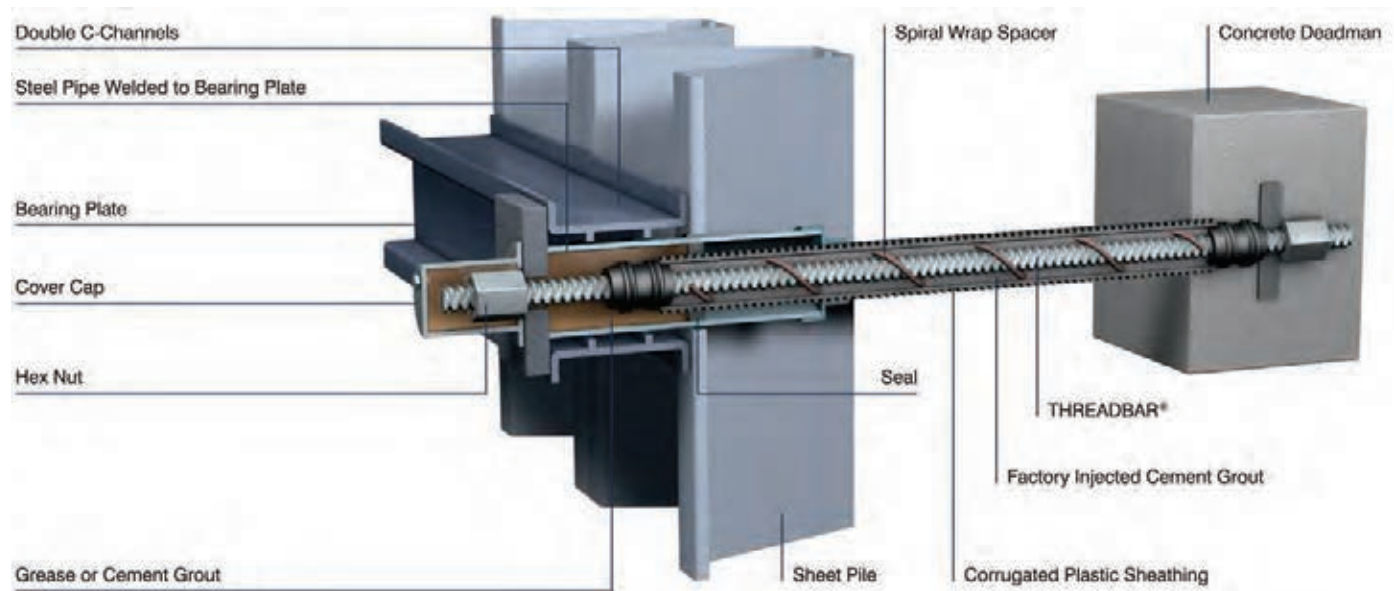

WALER CONNECTION

Short bolts are needed to connect a standard sheet pile wall or a modular sheet pile wall to a load distributing double channel beam. This can be done with Grade 75 or Grade 80 THREADBAR®.

The required length of the bar depends on the depth of the sheet pile profile, the width of the beam, the plate thickness and the nut length.

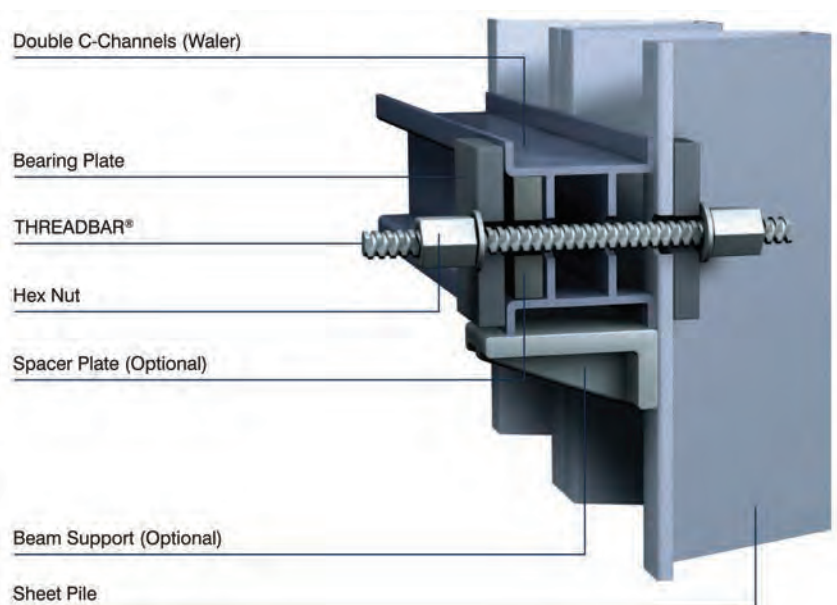

THREADBAR® REINFORCING SYSTEMS

TIE ROD CONNECTIONS

Anchorage in different variations for steel and concrete structures

- Clevis connection
- Eye anchor connection
- Welded connection
- Embedded connection
- Plate-nut connection

FEATURES

- Articulated
- Angle compensating
- Self-aligning under load
- Tensionable

COUPLERS AND CONNECTIONS

COUPLER



TURNBUCKLE



DOUBLE EYE ANCHOR CONNECTION

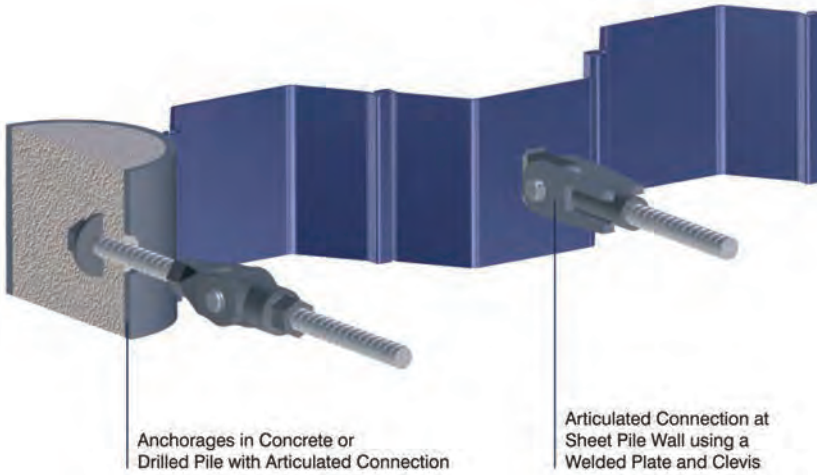
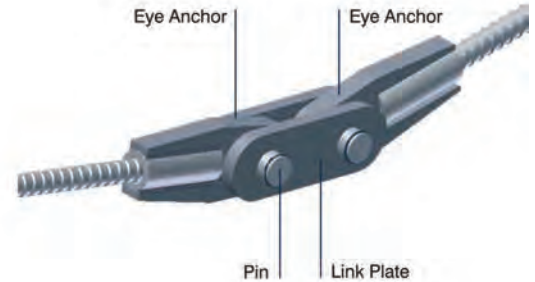

GRADE 75, 80 & 100 THREADBAR® – REINFORCING STEEL PER ASTM A615

THREADBAR® Designation	Maximum THREADBAR® Diameter			Minimum Yield Stress (f _y)		Nominal Cross Section Area (A _s)		Minimum Yield Load (f _y x A _s)		Nominal Weight	
	mm	in	mm	ksi	MPa	in ²	mm ²	kips	kN	lbs/ft	kg/m
GRADE 75 and 80											
#6	19	0.86	22	75	517	0.44	284	33.0	147	1.50	2.23
#7	22	0.99	25	75	517	0.60	387	45.0	200	2.04	3.04
#8	25	1.12	28	75	517	0.79	510	59.3	264	2.67	3.97
#9	29	1.26	32	75	517	1.00	645	75.0	334	3.40	5.06
#10	32	1.43	36	75	517	1.27	819	95.3	424	4.30	6.40
#11	36	1.61	41	75	517	1.56	1,006	117.0	520	5.31	7.90
#14	43	1.86	47	80	552	2.25	1,452	180.0	801	7.65	11.38
#18	57	2.50	64	80	552	4.00	2,581	320.0	1,423	13.60	20.24
#20	63	2.72	69	80	552	4.91	3,168	393.0	1,748	16.70	24.85
#24 ¹⁾	75	3.18	81	75	517	7.06	4,555	529.5	2,355	24.09	35.85
#28 ¹⁾	90	3.68	94	75	517	9.62	6,206	721.5	3,209	32.79	48.80
GRADE 100											
#6	19	19	22	100	689	0.44	284	44.0	196	1.50	2.23
#7	22	22	25	100	689	0.60	387	60.0	267	2.04	3.04
#8	25	25	28	100	689	0.79	510	79.0	351	2.67	3.97
#9	29	29	32	100	689	1.00	645	100.0	445	3.40	5.06
#10	32	32	36	100	689	1.27	819	127.0	565	4.30	6.40
#11	36	36	41	100	689	1.56	1,006	156.0	694	5.31	7.90
#14	43	43	47	100	689	2.25	1,452	225.0	1,001	7.65	11.38
#18	57	57	64	100	689	4.00	2,581	400.0	1,779	13.60	20.24
#20	63	63	69	100	689	4.91	3,168	491.0	2,184	16.70	24.85

Note: Maximum allowable temporary tension is 90% of yield load. Mill length is 60 ft (#6 through #20) and 53 ft for #24 and #28.

¹⁾ Threadbar sizes not listed by ASTM A 615 but yield strength is in conformance with A615 standard.

THREADBAR® REINFORCING SYSTEMS

INTRODUCTION

THREADBAR® Reinforcing Steel is available in Grades 75, 80, 100 for sizes #6 through #20, and Grade 75 to #24 and #28. Threadbars conform to the requirements of ASTM A615, except in markings. Threadbars may be shipped to the job in mill lengths or fabricated to specifications.

THREADBAR® Reinforcing Steel has a continuous rolled-in pattern of thread-like deformations along its entire length. More durable than machined threads, the deformations allow nuts couplers to thread onto a Threadbar at any point along its length.

Threadbars may be epoxy coated in accordance with ASTM A775 or galvanized in accordance to ASTM A123. Threaded accessories for coated bars thread over the coating.

ADVANTAGES OF HIGH-STRENGTH THREADBAR® REINFORCEMENT

- Fewer bars to handle
- Less congestion
- Lighter reinforcement assemblies
- Faster construction
- Easy to install coupler system
- Can replace rebar terminator with a bearing plate with top and bottom nuts

Having to hoist, handle and place a lower volume of reinforcing steel makes installation simpler and faster. And, less congestion results in higher quality concrete placement with reduced risk of consolidation issues. All these advantages result in a reduced volume of steel and shorter construction time leading to a lower overall cost of the reinforced concrete structure.

FIELDS OF APPLICATION

- Concrete reinforcement
- Micropiles
- Auger cast piles
- Caissons
- Drilled shafts

THREADBAR® PROPERTIES – REINFORCING STEEL PER ASTM A615R

THREADBAR® Designation	Maximum THREADBAR® Diameter			Minimum Yield Stress (f_y)		Nominal Cross Section Area (A_g)		Minimum Yield Load ($f_y \times A_g$)		Nominal Weight	
	mm	in	mm	ksi	MPa	in ²	mm ²	kips	kN	lbs/ft	kg/m
GRADE 75, 80 THREADBAR®											
#6	19	0.86	22	75	517	0.44	284	33.0	147	1.50	2.23
#7	22	0.99	25	75	517	0.60	387	45.0	200	2.04	3.04
#8	25	1.12	28	75	517	0.79	510	59.3	264	2.67	3.97
#9	29	1.26	32	75	517	1.00	645	75.0	334	3.40	5.06
#10	32	1.43	36	75	517	1.27	819	95.3	424	4.30	6.40
#11	36	1.61	41	75	517	1.56	1,006	117.0	520	5.31	7.90
#14	43	1.86	47	80	552	2.25	1,452	180.0	801	7.65	11.38
#18	57	2.50	64	80	552	4.00	2,581	320.0	1,423	13.60	20.24
#20	63	2.72	69	80	552	4.91	3,168	393.0	1,748	16.70	24.85
#24 ¹⁾	75	3.18	81	75	517	7.06	4,555	529.5	2,355	24.09	35.85
#28 ¹⁾	90	3.68	94	75	517	9.62	6,206	721.5	3,209	32.79	48.80
GRADE 100 THREADBAR®											
#6	19	0.86	22	100	689	0.44	284	44.0	196	1.50	2.23
#7	22	0.99	25	100	689	0.60	387	60.0	267	2.04	3.04
#8	25	1.12	28	100	689	0.79	510	79.0	351	2.67	3.97
#9	29	1.26	32	100	689	1.00	645	100.0	445	3.40	5.06
#10	32	1.43	36	100	689	1.27	819	127.0	565	4.30	6.40
#11 ²⁾	36	1.61	41	100	689	1.56	1,006	156.0	694	5.31	7.90
#14 ²⁾	43	1.86	47	100	689	2.25	1,452	225.0	1,001	7.65	11.38
#18 ²⁾	57	2.50	64	100	689	4.00	2,581	400.0	1,779	13.60	20.24
#20 ²⁾	63	2.72	69	100	689	4.91	3,168	491.0	2,184	16.70	24.85

Note: Mill length is 60 ft (#6 through #20) and 53 ft for #24 and #28.

¹⁾ Threadbar sizes not listed by ASTM A 615 but yield strength is in conformance with A615 standard.

²⁾ #11, #14, #18 and #20 Threadbars and their Couplers have ICC-ES Evaluation Report Approval ESR-3367.

THREADBAR® REINFORCING SYSTEMS

COUPLER SYSTEM

Couplers and hex nuts develop the full ultimate load of the Threadbar. Slippage of the coupler under stress is controlled by torquing opposing Threadbars together or by using nuts. The magnitude of the torque required varies with the allowable slip and Threadbar size.

The THREADBAR® reinforcing system offers a simple, reliable and economical splice. A splice requires less crane time and less labor time for assembly than required for other splices.

Unlike some splices, the splice may be installed in adverse weather conditions and does not create a fire hazard. Opposing Threadbars need only to be chalk marked before assembly to assure proper engagement, supervision and quality control requirements are minimized.

COUPLER WITH HEXNUTS

When opposing threadbars are not torqued together, hex nuts will be used on each end of the coupler and tightened against the coupler.

The splice will develop the full ultimate load of the bar in tension and compression.

COUPLER WITH LOCKNUTS

Locknuts can also be used each side end of the coupler similar to hex nuts. The splice will develop the full load ultimate load of the bar in tension and about half the ultimate load in compression.

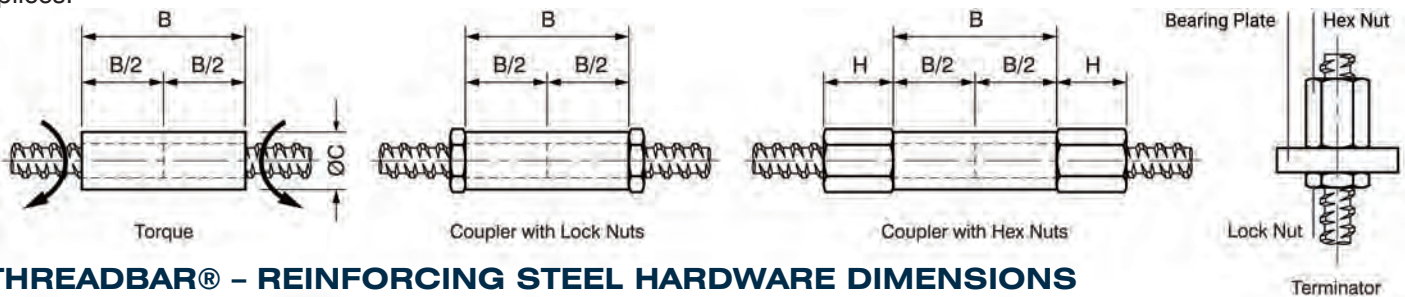

THREADBAR® - REINFORCING STEEL HARDWARE DIMENSIONS

THREADBAR® Designation	Hexnut Length H		Coupler Length B		Coupler Outer Diameter ØC	
	in	mm	in	mm	in	mm
GRADE 75, 80 THREADBAR®						
#6	1.43	36	3.12	79	1.22	31
#7	1.71	43	3.73	95	1.41	36
#8	1.84	47	4.03	102	1.59	40
#9	2.30	58	5.02	128	1.79	45
#10	2.56	65	5.70	145	2.02	51
#11	2.89	73	6.37	162	2.25	57
#14	3.55	90	7.82	199	2.65	67
#18	4.23	107	9.35	237	3.50	89
#20	4.85	123	10.38	264	3.86	98
"#24	4.10	104	9.20	234	4.75	121
#28	4.80	122	10.61	269	5.38	137
GRADE 100 THREADBAR®						
#6	2.88	73	6.25	159	1.25	32
#7	3.13	80	7.00	178	1.50	38
#8	3.38	86	7.13	181	1.75	44
#9	3.50	89	7.25	184	1.88	48
#10	3.75	95	7.50	191	2.13	54
#11	3.88	99	8.00	203	2.38	60
#14	4.50	114	8.25	210	2.75	70
#18	5.25	133	10.50	267	3.63	92
#20	6.00	152	12.25	311	4.00	102



THREADBAR® SOIL NAIL WITH DCP FOR THE MOST AGGRESSIVE SOIL CONDITIONS

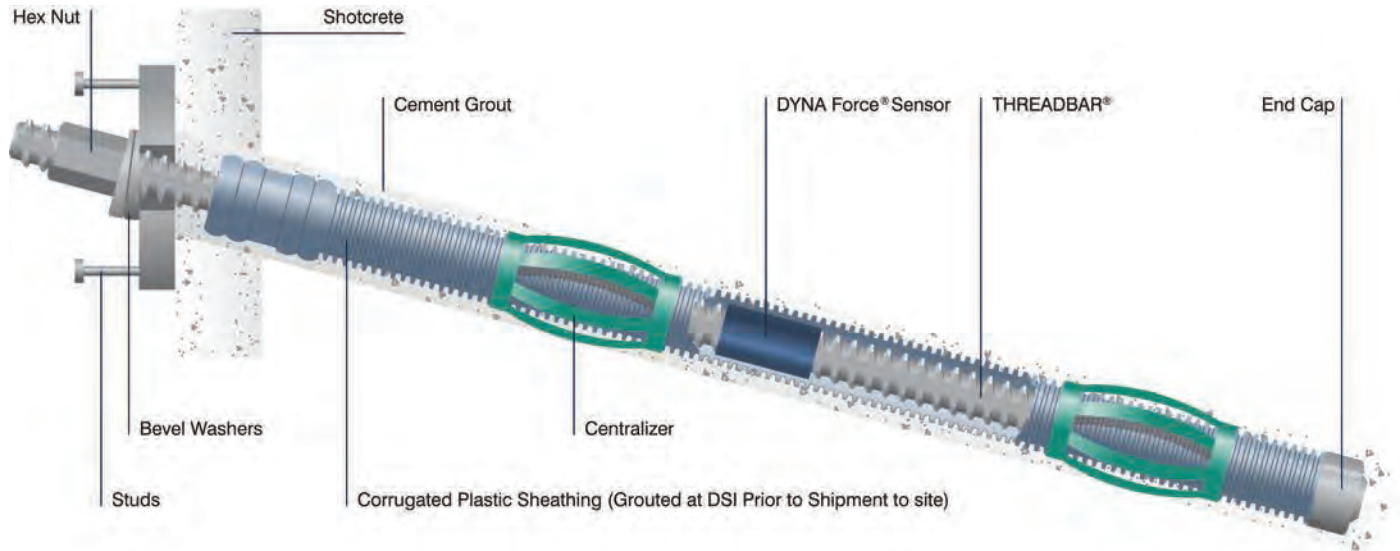

THREADBAR® SOIL NAIL - BARE, EPOXY COATED OR GALVANIZED

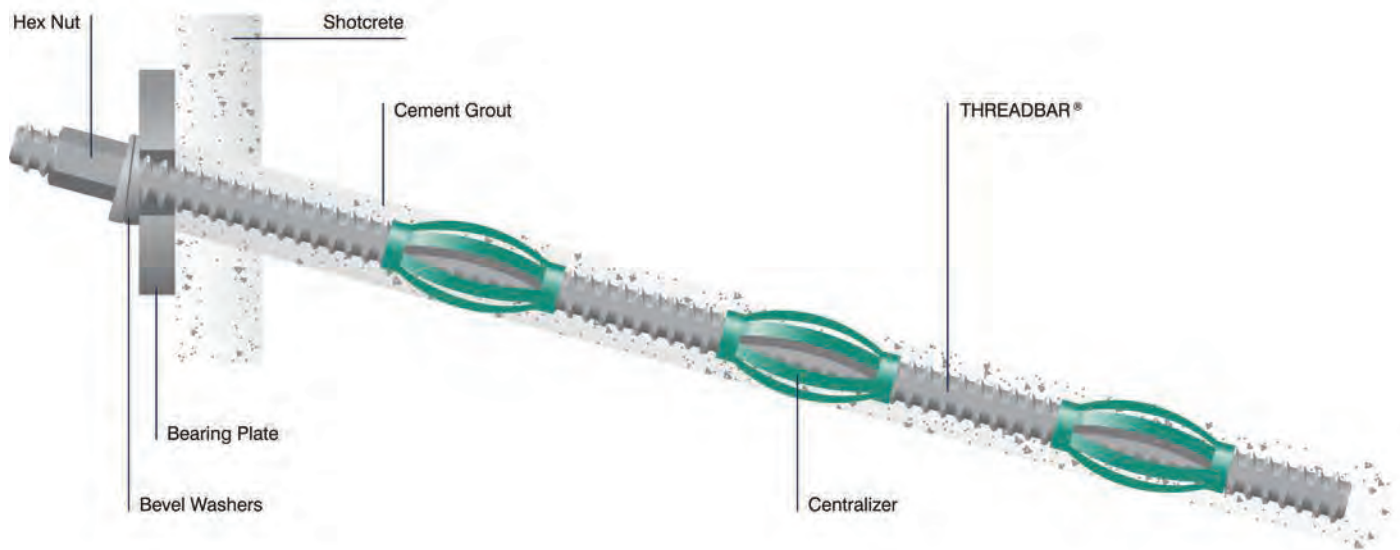

SOIL NAILS

KEY FEATURES

- Top-down construction
- Lower construction costs versus tieback walls with soldier beams and lagging
- Can be used for temporary and permanent applications
- Simple components and assembly
- Easy to install and test
- Durable full length threads allow for cutting and coupling the bar at any point along its length

GRADE 75, 80 & 100 THREADBAR® – REINFORCING STEEL PER ASTM A615

THREADBAR® Designation	Maximum THREADBAR® Diameter			Minimum Yield Stress (f_y)		Nominal Cross Section Area (A_s)		Minimum Yield Load ($f_y \times A_s$)		Nominal Weight	
	mm	in	mm	ksi	MPa	in ²	mm ²	kips	kN	lbs/ft	kg/m
Grade 75 and 80 ¹⁾											
#6	19	0.86	22	75	517	0.44	284	33.0	147	1.50	2.23
#7	22	0.99	25	75	517	0.60	387	45.0	200	2.04	3.04
#8	25	1.12	28	75	517	0.79	510	59.3	264	2.67	3.97
#9	29	1.26	32	75	517	1.00	645	75.0	334	3.40	5.06
#10	32	1.43	36	75	517	1.27	819	95.3	424	4.30	6.40
#11	36	1.61	41	75	517	1.56	1,006	117.0	520	5.31	7.90
#14	43	1.86	47	80	552	2.25	1,452	180.0	801	7.65	11.38
Grade 100											
#6	19	0.86	22	100	689	0.44	284	44.0	196	1.50	2.23
#7	22	0.99	25	100	689	0.60	387	60.0	267	2.04	3.04
#8	25	1.12	28	100	689	0.79	510	79.0	351	2.67	3.97
#9	29	1.26	32	100	689	1.00	645	100.0	445	3.40	5.06
#10	32	1.43	36	100	689	1.27	819	127.0	565	4.30	6.40
#11	36	1.61	41	100	689	1.56	1,006	156.0	694	5.31	7.90
#14	43	1.86	47	100	689	2.25	1,452	225.0	1,001	7.65	11.38

¹⁾Note: Maximum allowable temporary tension is 90% of minimum yield load.
Mill length is 60 ft.



THREADBAR® with Centralizer

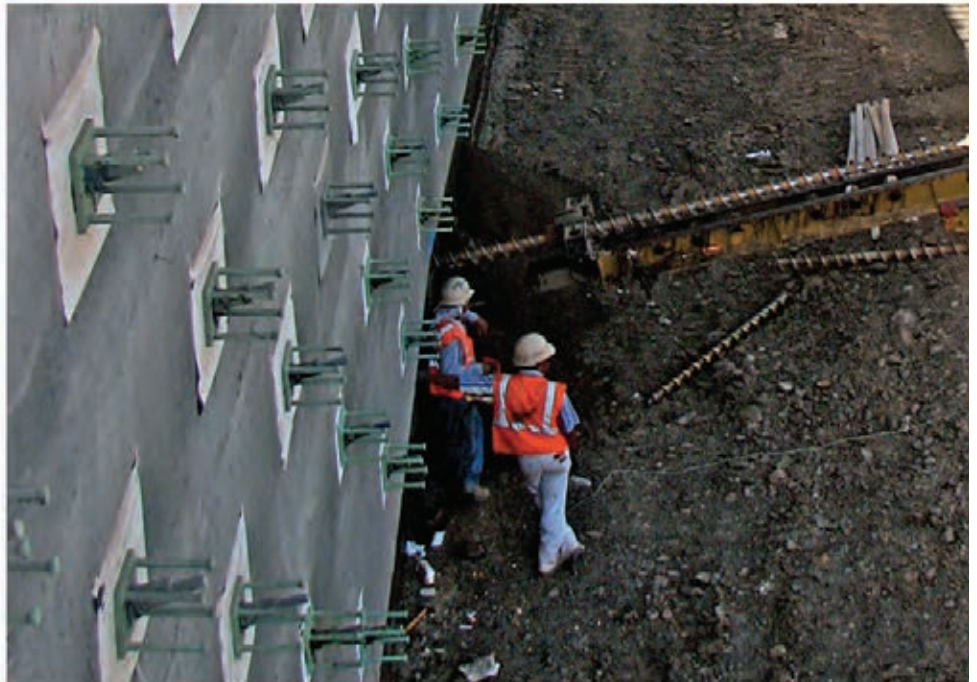

THREADBAR® ANCHORS

KEY FEATURES

- Threadbars with proven coarse thread along the entire length. Bar
- length can be adjusted on site without any problems
- Variable anchor head and angle compensation designs
- Easy handling, tensioning, retensioning or detensioning
- Can be utilized for fully or partially removable anchors
- Can be supplied with Double Corrosion
- Protection (DCP) for permanent applications

FIELDS OF APPLICATION

- Excavations
- Tiebacks
- Rock and slope stabilization
- Tiedown anchors

THREADBAR® ANCHOR – PERMANENT (DCP)

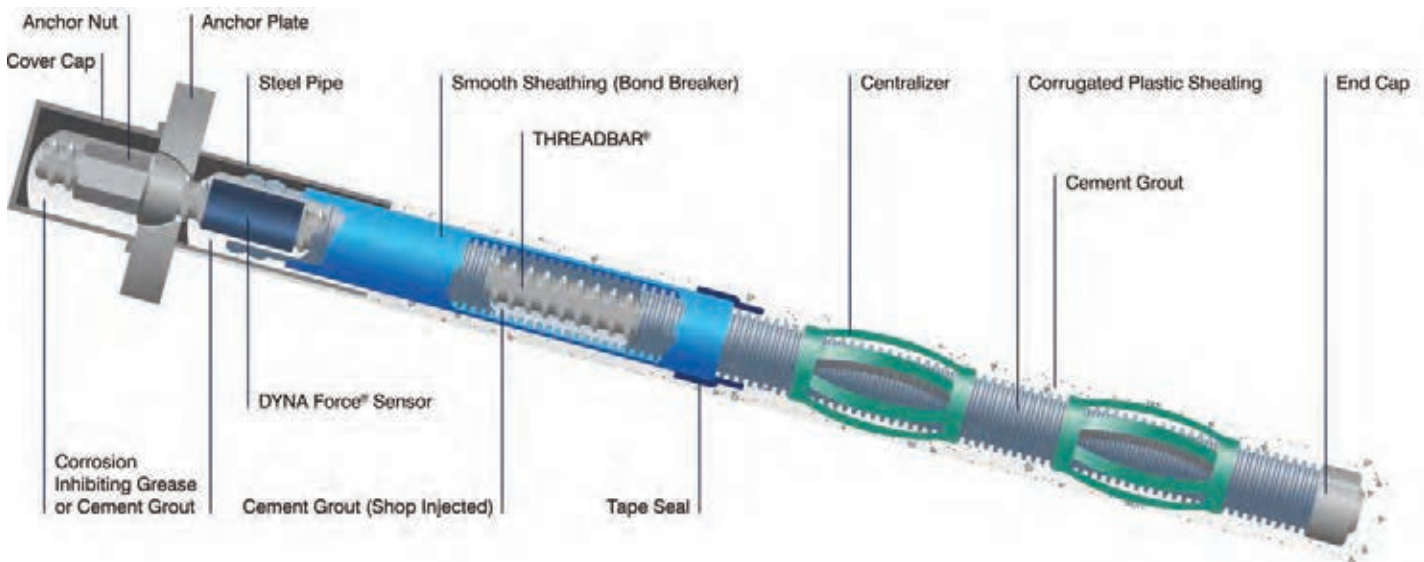

THREADBAR® ANCHOR – TEMPORARY

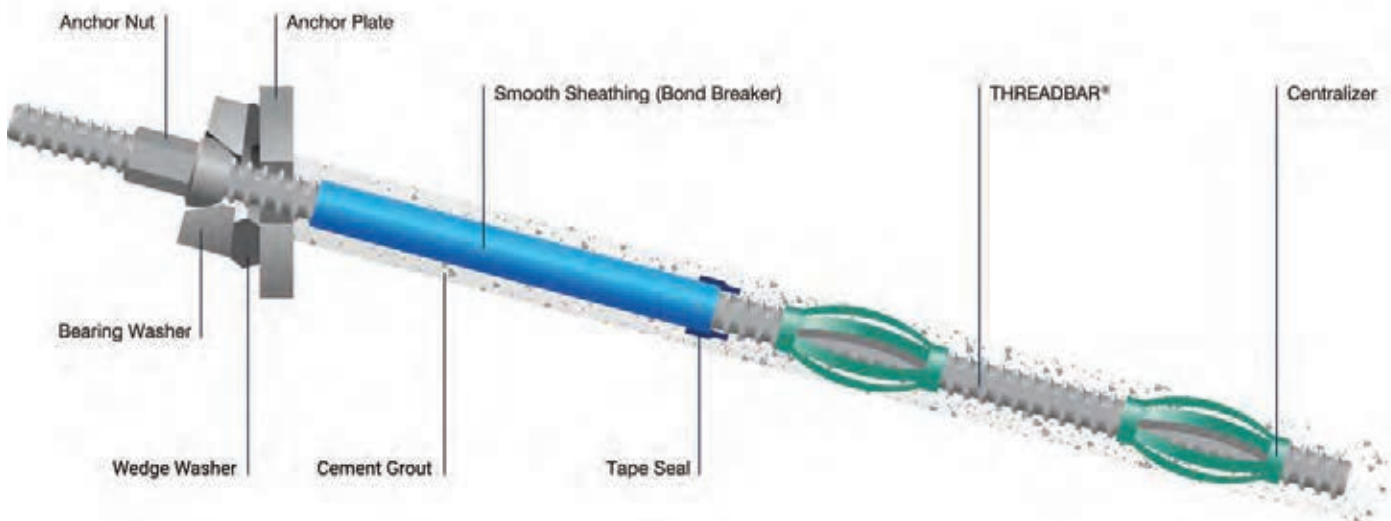

THREADBAR® ANCHORS

GRADE 150 THREADBAR® – PRESTRESSING STEEL PER ASTM A722

THREADBAR® Designation		Maximum THREADBAR® Diameter		Minimum Ultimate Tensile Strength (f_u)		Nominal Cross Section Area (A_s)		Minimum Ultimate Tensile Load ($f_u \times A_s$)		Nominal Weight	
in	mm	in	mm	ksi	MPa	in ²	mm ²	kips	kN	lbs/ft	kg/m
1	26	1.20	30	150	1,034	0.85	548	127.5	567	3.01	4.48
1 ¼	32	1.445	37	150	1,034	1.25	806	187.5	834	4.39	6.53
1 ½	36	1.630	41	150	1,034	1.58	1,019	237.0	1,054	5.56	8.27
1 ¾	46	2.08	53	150	1,034	2.58	1,665	387.0	1,721	9.37	13.94
2 ¼ ¹⁾	57	2.482	63	150	1,034	4.08	2,632	612.0	2,722	14.55	21.65
2 ½	65	2.790	71	150	1,034	5.16	3,329	774.0	3,443	18.20	27.08
3	75	3.146	80	150	1,034	6.85	4,419	1,028	4,571	24.09	35.85

Note: Maximum allowable temporary test tension is 80% of minimum ultimate tensile load. Mill lengths are 60 ft for 1", 1 ¼", 1 ½" and 1 ¾" and 45 ft for 2 ¼", 2 ½" and 3" bars.

¹⁾ Threadbar size not listed in the ASTM A 722 but its strength is in conformance with this standard.

WARNING: DO NOT WELD on or near A722 prestressing bars or their anchorages.

THREADBAR® ANCHOR – PARTIALLY REMOVABLE

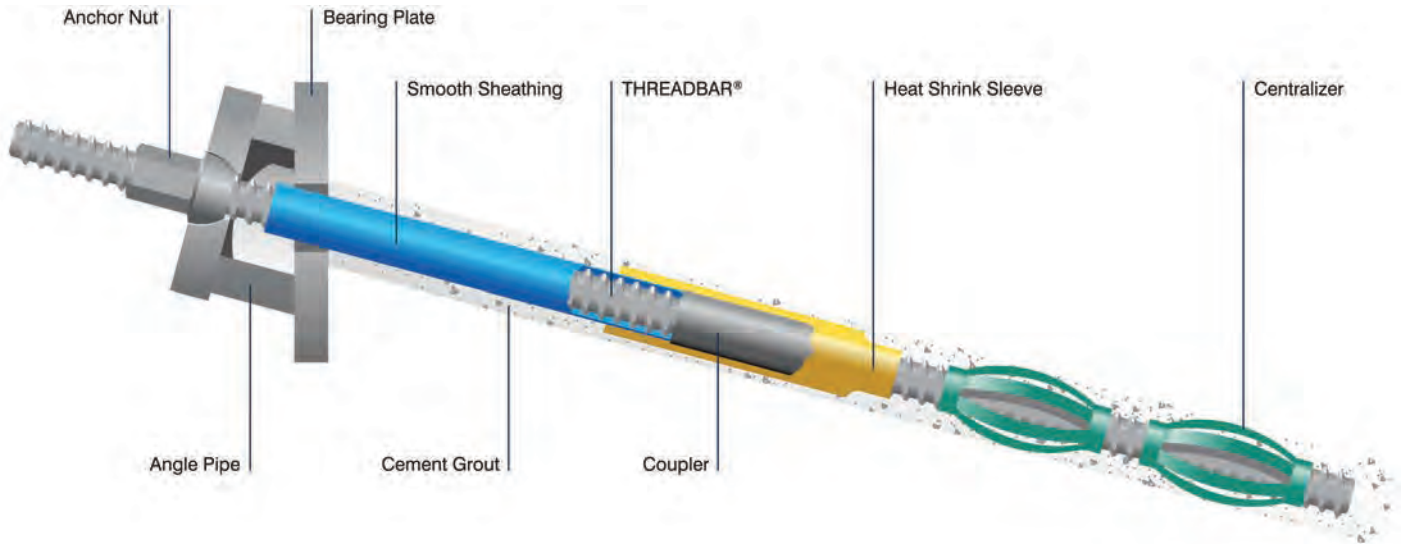

THREADBAR® ANCHOR – FULLY REMOVABLE

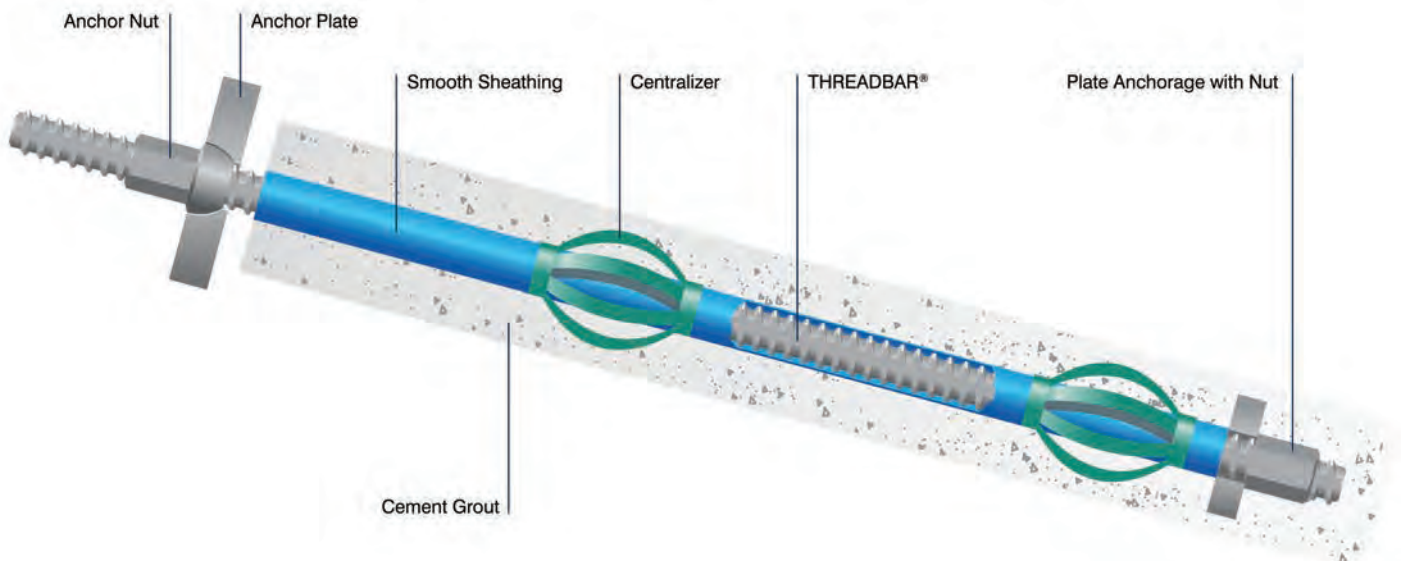

STRAND ANCHORS

PERMANENT (DCP) ANCHOR – KEY FEATURES

- Long-lasting system for permanent use
- Variable anchor head and angle compensation designs
- Double Corrosion Protection (DCP) is achieved by protecting the strands with barrier against corrosion. It consists of a corrugated sheathing, a pipe welded to the bearing plate and a cover cap along with encasement in cement grout.

FIELDS OF APPLICATION

- Retaining walls
- Rock and slope stabilization
- Tiedown anchors
- Excavations

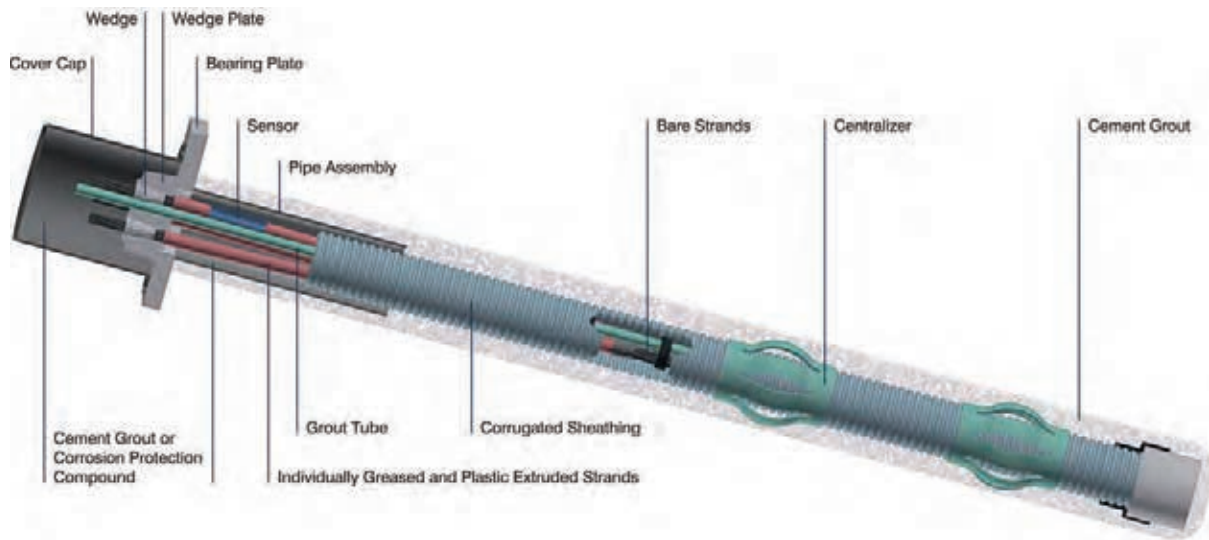

TEMPORARY ANCHOR – KEY FEATURES

- Temporary system for a service life of up to two years
- Variable anchor head and angle compensation designs

FIELDS OF APPLICATION

- Excavations
- Temporary structures

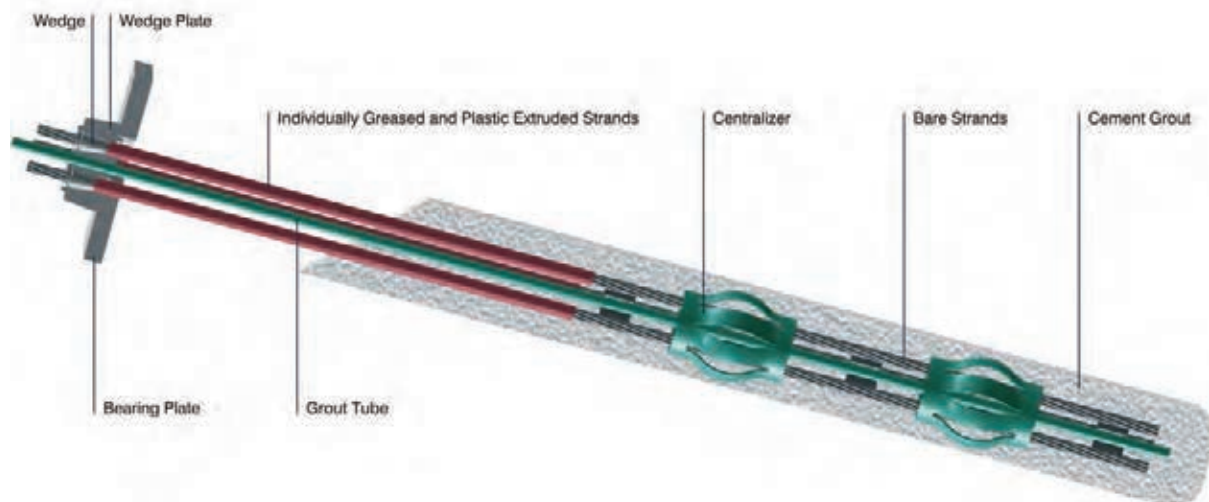

STRAND ANCHORS

STRAND ANCHORS PROPERTIES

Strand Anchors utilize 0.6" dia. 7-wire, low relaxation 270 ksi Strand conforming to ASTM A416 (bare strand) or ASTM A882 (epoxy coated strand).

Number of Strands	Nominal Cross Section Area (A_{ps})		Ultimate Strength ($F_{pu} \times A_{ps}$)		Prestressing Force						Nominal Weight (Bare Steel only)	
					$0.80 F_{pu} \times A_{ps}$		$0.70 F_{pu} \times A_{ps}$		$0.60 F_{pu} \times A_{ps}$			
ea	in ²	mm ²	kips	kN	kips	kN	kips	kN	kips	kN	lbs/ft	kg/m
1	0.217	140	58.6	261	46.9	208	41	182	35.2	156	0.74	1.09
2	0.434	280	117.2	521	93.7	417	82	365	70.3	313	1.48	1.64
3	0.651	420	175.8	782	140.6	625	123	547	105.5	469	2.22	3.27
4	0.868	560	234.4	1,043	187.5	834	164.1	730	140.6	626	2.96	4.46
5	1.085	700	293.0	1,303	234.4	1,043	205.1	912	175.8	782	3.70	5.51
6	1.302	840	351.6	1,564	281.3	1,251	246.1	1,095	210.9	938	4.44	6.55
7	1.519	980	410.2	1,825	328.2	1,460	287.2	1,277	246.2	1,095	5.18	7.74
8	1.736	1,120	468.8	2,085	375.0	1,668	328.1	1,460	281.3	1,251	5.92	8.78
9	1.953	1,260	527.4	2,346	421.9	1,877	369.2	1,642	316.4	1,408	6.66	9.97
12	2.604	1,680	703.2	3,128	562.6	2,503	492.3	2,190	422.0	1,877	8.88	13.24
15	3.255	2,100	879.0	3,910	703.2	3,128	615.3	2,737	527.4	2,346	11.10	16.52
19	4.123	2,660	1,113.4	4,953	890.7	3,962	779.4	3,467	668.0	2,972	14.06	20.98
27	5.859	3,780	1,582.2	7,038	1,265.8	5,631	1,107.6	4,927	949.4	4,223	19.98	29.76
37	8.029	5,180	2,168.2	9,645	1,734.6	7,716	1,517.8	6,751	1,301.0	5,787	27.38	40.78
48	10.416	6,720	2,812.8	12,512	2,250.2	10,009	1,968.9	8,758	1,687.7	7,507	35.52	52.83
54	11.718	7,560	3,164.4	14,076	2,531.5	11,261	2,215.1	9,853	1,898.6	8,446	39.96	59.38
61	13.237	8,540	3,574.6	15,901	2,859.7	12,721	2,502.2	11,131	2,144.8	9,540	45.14	67.12

A_{ps} = Area Prestressing Steel.

F_{pu} = Minimum Ultimate Strength.

Please consult your local sales office for systems exceeding 61 strands.

DCP STRAND ANCHOR AND WEDGE PLATE DIMENSIONS

Strand Range Inside Sheathing ¹⁾	HDPE Corrugated			Trumpet Pipe		Wedge Plate Dimensions			
	Nom. Size in	O.D. in	O.D. mm	O.D. in	O.D. mm	ØG in	ØG mm	H in	H mm
1-3	2	2.44	62	4.5	114	4.69	119	1.8	46
4	2.5	2.92	74	4.5	114	4.69	119	1.8	46
5-6	2.5	2.92	74	4.5	114	5.61	142	2.2	56
7	3	3.60	91	4.5	114	5.61	142	2.2	56
8-9	3	3.60	91	5.63	143	5.75	146	1.69	43
10-12	4	4.60	117	5.63	143	6.75	171	1.95	50
13-15	4	4.60	117	6.63	168	7.09	180	1.97	50
16-17	4	4.60	117	8.63	219	7.87	200	2.17	55
18-19	5	5.85	149	8.63	219	7.87	200	2.17	55
20-24	5	5.85	149	8.63	219	9.45	240	2.95	75
25-27	6	6.8	173	8.63	219	9.45	240	2.95	75

¹⁾ Based on the use of a single 0.5" ID x 0.75" OD internal grout tube. Bearing plate sizes subject to project specific requirements.

Strand anchors larger than 27 strand systems also available.

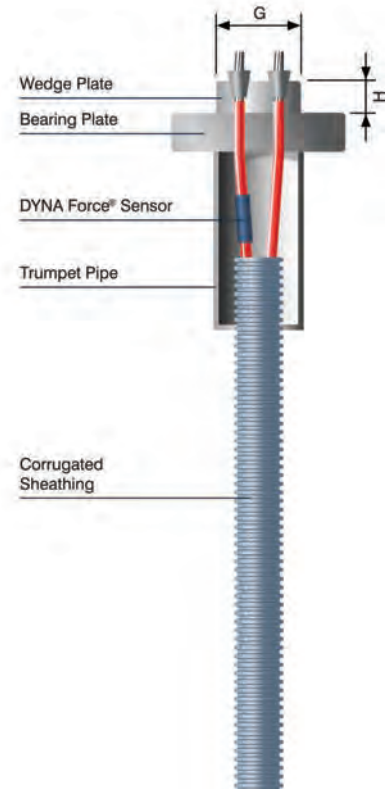

MICROPILES

BASIC CONCEPT

A drilled and grouted micropile, with a diameter of less than 12 inches. It is centrally reinforced with either one or a group of **THREADBARS®**. The deformations on the bar transfer the load into the surrounding grout body and friction transfers the load from the grout into the ground.

SINGLE CORROSION PROTECTION (SCP)

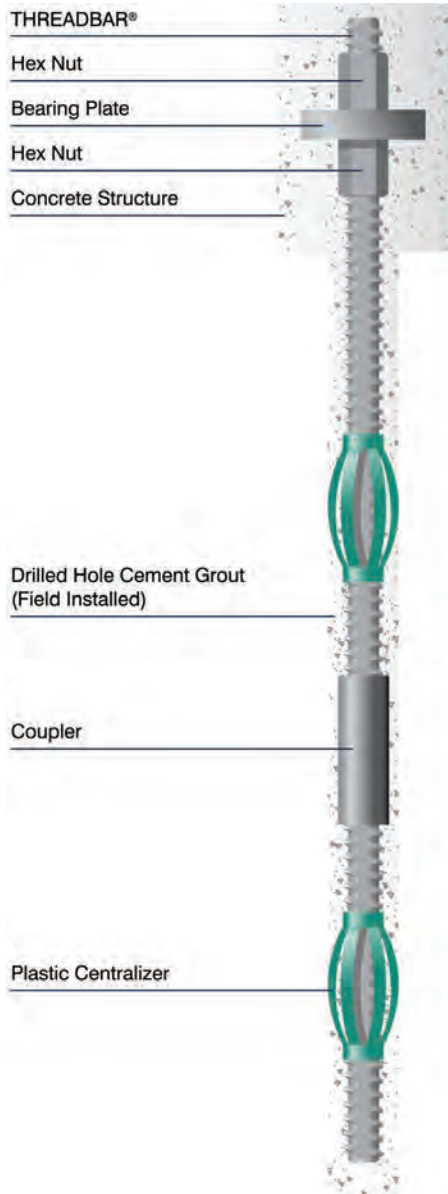

KEY FEATURES

- Compact lightweight drilling equipment allows for pile installation even in areas with low headroom
- Small economic drill hole diameters
- Drill holes can be placed closely to existing walls or structures
- Vibration free drilling prevents damage to adjacent structures
- Double Corrosion Protected (DCP) bars may be utilized for piles in aggressive ground
- Multiple bars can be installed into a single borehole
- Short bar sections with couplers can be utilized in low headroom locations
- Continuous, coarse thread allows for rough site handling and for easy on site length adjustments since cutting or coupling of the rod is possible along its entire length

DOUBLE CORROSION PROTECTION (DCP)

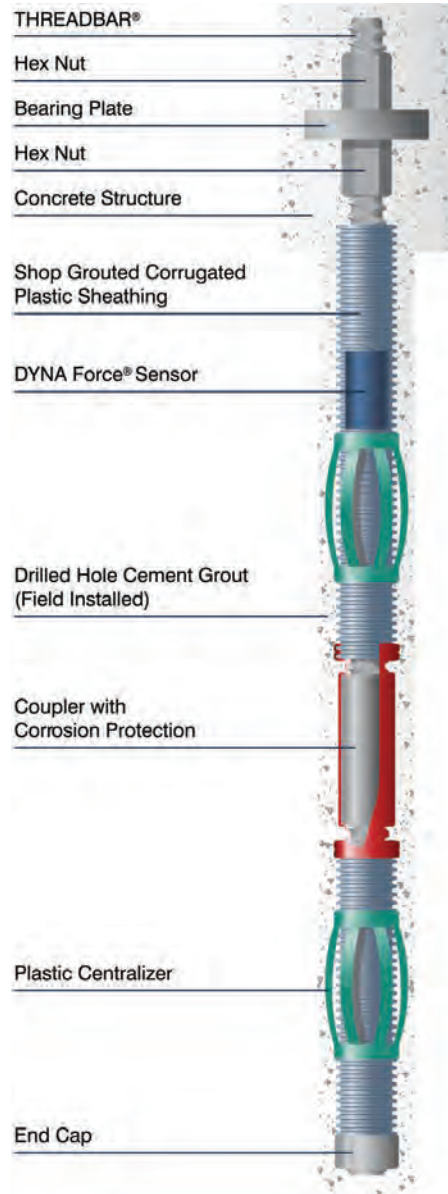

THREADBAR® PROPERTIES

GRADE 75, 80 THREADBAR® – REINFORCING STEEL PER ASTM A615

THREADBAR® Designation	Maximum THREADBAR® Diameter			Minimum Yield Stress (f _y)		Nominal Cross Section Area (A _s)		Minimum Yield Load (f _y x A _s)		Nominal Weight	
	mm	in	mm	ksi	MPa	in ²	mm ²	kips	kN	lbs/ft	kg/m
#6	19	0.86	22	75	517	0.44	284	33.0	147	1.50	2.23
#7	22	0.99	25	75	517	0.60	387	45.0	200	2.04	3.04
#8	25	1.12	28	75	517	0.79	510	59.3	264	2.67	3.97
#9	29	1.26	32	75	517	1.00	645	75.0	334	3.40	5.06
#10	32	1.43	36	75	517	1.27	819	95.3	424	4.30	6.40
#11	36	1.61	41	75	517	1.56	1,006	117.0	520	5.31	7.90
#14	43	1.86	47	80	552	2.25	1,452	180.0	801	7.65	11.38
#18	57	2.50	64	80	552	4.00	2,581	320.0	1,423	13.60	20.24
#20	63	2.72	69	80	552	4.91	3,168	393.0	1,748	16.70	24.85
#24 ¹⁾	75	3.18	81	75	517	7.06	4,555	529.5	2,355	24.09	35.85
#28 ¹⁾	90	3.68	94	75	517	9.62	6,206	721.5	3,209	32.79	48.80

Note: Maximum allowable temporary tension is 90% of minimum yield load. Mill length is 60 ft (#6 through #20) and 53 ft for #24 and #28.

¹⁾ Threadbar sizes not listed by ASTM A 615 but yield strength is in conformance with A615 standard.

GRADE 100 THREADBAR® – REINFORCING STEEL PER ASTM A615

THREADBAR® Designation	Maximum THREADBAR® Diameter			Minimum Yield Stress (f _y)		Nominal Cross Section Area (A _s)		Minimum Yield Load (f _y x A _s)		Nominal Weight	
	mm	in	mm	ksi	MPa	in ²	mm ²	kips	kN	lbs/ft	kg/m
#6	19	0.86	22	100	689	0.44	284	44.0	196	1.50	2.23
#7	22	0.99	25	100	689	0.60	387	60.0	267	2.04	3.04
#8	25	1.12	28	100	689	0.79	510	79.0	351	2.67	3.97
#9	29	1.26	32	100	689	1.00	645	100.0	445	3.40	5.06
#10	32	1.43	36	100	689	1.27	819	127.0	565	4.30	6.40
#11	36	1.61	41	100	689	1.56	1,006	156.0	694	5.31	7.90
#14	43	1.86	47	100	689	2.25	1,452	225.0	1,001	7.65	11.38
#18	57	2.50	64	100	689	4.00	2,581	400.0	1,779	13.60	20.24
#20	63	2.72	69	100	689	4.91	3,168	491.0	2,184	16.70	24.85

Note: Maximum allowable temporary tension is 90% of minimum yield load. Mill length is 60 ft.

GRADE 150 THREADBAR® – PRESTRESSING STEEL PER ASTM A722

THREADBAR® Designation		Maximum THREADBAR® Diameter		Minimum Ultimate Tensile Strength (f _u)		Nominal Cross Section Area (A _s)		Minimum Ultimate Tensile Load (f _u x A _s)		Nominal Weight	
in	mm	in	mm	ksi	MPa	in ²	mm ²	kips	kN	lbs/ft	kg/m
1	26	1.20	30	150	1,034	0.85	548	127.5	567	3.01	4.48
1 ¼	32	1.445	37	150	1,034	1.25	806	187.5	834	4.39	6.53
1 ½	36	1.630	41	150	1,034	1.58	1,019	237.0	1,054	5.56	8.27
1 ¾	46	2.08	53	150	1,034	2.58	1,665	387.0	1,721	9.37	13.94
2 ¼ ¹⁾	57	2.482	63	150	1,034	4.08	2,632	612.0	2,722	14.55	21.65
2 ½	65	2.790	71	150	1,034	5.16	3,329	774.0	3,443	18.20	27.08
3	75	3.146	80	150	1,034	6.85	4,419	1,028	4,571	24.09	35.85

Note: Maximum allowable temporary test tension is 80% of minimum ultimate tensile load. Mill lengths are 60 ft for 1", 1 ¼", 1 ½" and 1 ¾" and 45 ft for 2 ¼", 2 ½" and 3" bars.

¹⁾ Threadbar size not listed in the ASTM A 722 but its strength is in conformance with this standard.

WARNING: DO NOT WELD on or near A722 prestressing bars or their anchorages.

DRILL HOLLOW BAR SYSTEM

BASIC CONCEPT

The Drill Hollow Bar System consists of fully threaded steel bar sections, couplers, nuts and drill bits.

It can be drilled and grouted into loose or collapsible soil without a casing.

The bar sections feature a hollow center that allows for a simultaneous drilling and grouting operation.

The Drill Hollow Bar serves as a drill rod. It is fitted with a lost drill bit at the front that can be adapted to different ground conditions. After each single bar section of 1 to 6 m, the subsequent bar is coupled to the previously installed section.

During drilling, cement grout is injected into the hollow core of the bar using an injection adapter that is mounted on the drill rig. The cement grout exits at the bottom end through openings in the drill bit. The injected grout initially serves

as slurry to stabilize the borehole and ensures the efficient flushing of the drill spoils. Once the grout reached strength it bonds the bar to the ground.

Once the required installation depth has been reached, the hollow bar serves as a steel tendon and can carry

out its function as a soil nail, rock bolt or pile upon the grout reaching its required strength.

The comprehensive Drill Hollow Bar System product range offers tendons with ultimate loads from 45 kips to 832 kips including all system components such as drill bits, couplers, spacers and anchor heads.

Additional installation tools such as injection adapters can be produced customized or adjusted to job site requirements on short notice.

DRILL HOLLOW BAR – SOIL NAIL

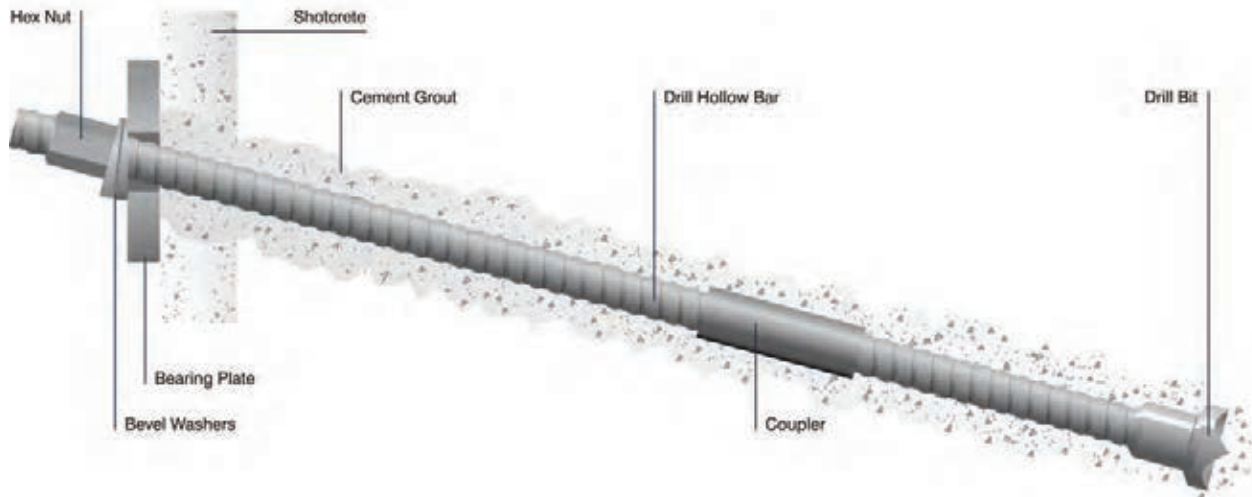

KEY FEATURES

- The tendon simultaneously serves as a drill rod
- Extremely fast installation because borehole drilling is made redundant by simultaneous drilling and grouting
- System can be installed in confined spaces utilizing simple and compact drilling equipment
- Variable anchorage and angle compensation designs
- Irregular grout body enhances capacity
- Drill bits are available for various ground conditions
- Can be used as a soil nail, rock bolt or a pile

FIELDS OF APPLICATION

- Slope, embankment and rock stabilization
- Shoring and excavations
- Fixation of rock fall mesh
- Avalanche barriers
- Foundations



Various Style Drill Bits for DYWI® Drill

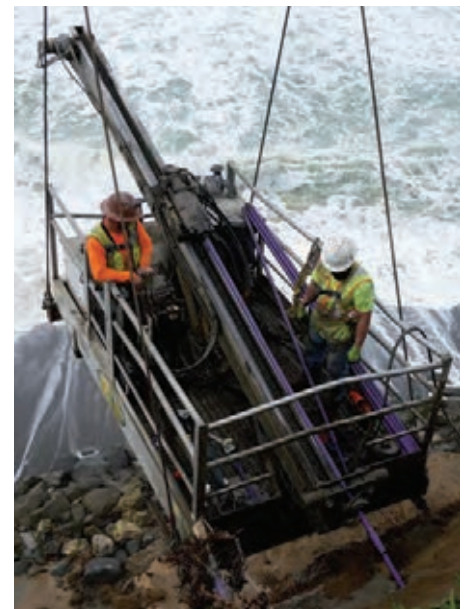

DRILL HOLLOW BAR MICROPILE

DRILL HOLLOW BAR – MICROPILE

Drill Hollow Bar

Hex Nut

Bearing Plate

Hex Nut

Concrete Structure

Drilled Hole
Cement Grout
(Injected during Drilling
Process)

Coupler

Drill Bit



Simultaneous Drilling and Grouting

DRILL HOLLOW BAR PROPERTIES

Bar Des.	Nominal Outer Diameter		Average Yield Strength (f_y)		Average Ultimate Tensile Strength (f_u)		Average Cross Section Area (A_s)		Yield Load ($f_y \times A_s$)		Ultimate Load ($f_u \times A_s$)		Nominal Weight	
	in	mm	ksi	Mpa	ksi	MPa	in ²	mm ²	kips	kN	kips	kN	lbs/ft	kg/m
R25N	1.00	25	90	620	120	830	0.37	240	34	150	45	200	1.28	1.90
R32N	1.26	32	94	650	116	800	0.54	350	52	230	63	280	1.81	2.70
R32S	1.26	32	94	650	120	830	0.67	430	63	280	81	360	2.28	3.40
R38N	1.50	38	97	670	122	840	0.91	590	90	400	112	500	3.16	4.70
R51L	2.00	51	87	600	107	740	1.15	740	101	450	124	550	3.97	5.90
T40N	1.57	40	99	680	123	850	1.19	770	118	525	148	660	4.03	6.00
R51N	2.00	51	97	670	123	850	1.46	940	142	630	180	800	4.97	7.40
T76N	3.00	76	83	570	110	760	3.22	2,080	270	1,200	360	1,600	10.95	16.30
T76S	3.00	76	87	600	112	770	3.81	2,460	337	1,500	427	1,900	12.97	19.30
T103N	4.00	103	81	560	103	710	4.96	3,200	405	1,800	517	2,300	16.80	25.00
T103S	4.00	103	74	510	103	710	8.06	5,200	600	2,670	832	3,700	26.88	40.00

Note: Maximum allowable temporary tension is the yield load. Cross section area is based on average internal diameter of the bar.
The ultimate tensile and yield strength are calculated average values.
Standard length = 9'-10" (3 m). Other lengths available on special order.





STRUCTURALS

WIDE FLANGE BEAMS

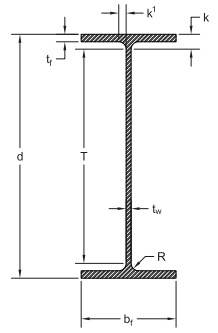

W44 & W1100

Prime Section Group	Section Size Inch x lbs/ft (mm x kg/m)	Area A Inch ² (mm ²)	Depth d Inch (mm)	Web Thickness t _w Inch (mm)	Flange		Distance			Fillet Radius R Inch (mm)	Elastic Properties						Plastic Modulus	
					Width b _f Inch (mm)	Thickness t _f Inch (mm)	T Inch (mm)	k Inch (mm)	k' Inch (mm)		X - X			Y - Y			Z _x Inch ³ (10 ³ mm ³)	Z _y Inch ³ (10 ³ mm ³)
											I _x Inch ⁴ (10 ⁶ mm ⁴)	S _x Inch ³ (10 ³ mm ³)	r _x Inch (mm)	I _y Inch ⁴ (10 ⁶ mm ⁴)	S _y Inch ³ (10 ³ mm ³)	r _y Inch (mm)		
44 x 16 1100 x 400	W44 x 335 W1100 x 499	98.7 63 500	44.02 1 118	1.025 26.0	15.945 405	1.770 45.0	37.993 965	3.014 77	1.694 43	1.18 30	31100 12 945	1410 23 106	17.8 452	1200 499	150 2 458	3.49 88.6	1620 26 547	236 3 867
	W44 x 290 W1100 x 433	85.8 55 100	43.62 1 108	0.865 22.0	15.825 402	1.575 40.0	37.983 965	2.819 72	1.614 41	1.18 30	27000 11 238	1240 20 320	17.8 452	1040 433	132 2 163	3.49 88.6	1410 23 106	205 3 359
	W44 x 262 W1100 x 390	77.2 49 700	43.31 1 100	0.785 20.0	15.750 400	1.415 36.0	37.993 965	2.659 68	1.574 40	1.18 30	24100 10 031	1110 18 190	17.7 450	923 384	117 1 917	3.47 88.1	1270 20 811	182 2 982
	W44 x 230 W1100 x 343	67.9 43 600	42.91 1 090	0.710 18.0	15.750 400	1.220 31.0	37.983 965	2.464 63	1.536 39	1.18 30	20800 8 658	971 15 912	17.5 445	796 331.3	101 1 655	3.43 87.1	1100 18 026	157 2 573

WIDE FLANGE BEAMS

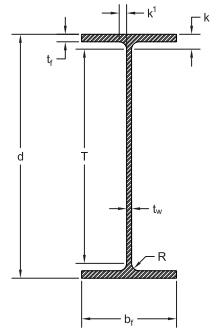

W40 & W1100

Prime Section Group	Section Size Inch x lbs/ft (mm x kg/m)	Area A Inch ² (mm ²)	Depth d Inch (mm)	Web Thickness t _w Inch (mm)	Flange		Distance			Fillet Radius R Inch (mm)	Elastic Properties						Plastic Modulus	
					Width b _f Inch (mm)	Thickness t _f Inch (mm)	T Inch (mm)	k Inch (mm)	k' Inch (mm)		X - X			Y - Y			Z _x Inch ³ (10 ³ mm ³)	Z _y Inch ³ (10 ³ mm ³)
											I _x Inch ⁴ (10 ² mm ⁴)	S _x Inch ³ (10 ³ mm ³)	r _x Inch (mm)	I _y Inch ⁴ (10 ² mm ⁴)	S _y Inch ³ (10 ³ mm ³)	r _y Inch (mm)		
40 x 16 1000 x 400	W40 x 431 W1000 x 642	126.7 81 800	41.26 1 048	1.340 34.0	16.220 412	2.360 60.0	34.053 865	3.604 92	1.851 47	1.18 30	34800 14 485	1690 27 694	16.6 422	1690 703	208 3 408	3.65 92.7	1960 32 119	328 5 375
	W40 x 397 W1000 x 591	117.0 75 300	40.95 1 040	1.220 31.0	16.120 409	2.200 55.9	34.063 865	3.444 87	1.791 46	1.18 30	32000 13 319	1560 25 564	16.6 422	1540 641	191 3 130	3.64 92.5	1800 29 497	300 4 916
	W40 x 372 W1000 x 554	109.4 70 600	40.63 1 032	1.160 29.5	16.065 408	2.045 52.0	34.053 865	3.289 84	1.761 45	1.18 30	29600 12 320	1460 23 925	16.5 419	1420 591	177 2 900	3.60 91.4	1680 27 530	277 4 539
	W40 x 362 W1000 x 539	107.0 68 700	40.55 1 030	1.120 28.4	16.020 407	2.010 51.1	34.043 865	3.254 83	1.741 44	1.18 30	28900 12 029	1420 23 270	16.5 419	1380 574	173 2 835	3.60 91.4	1640 26 875	270 4 424
	W40 x 324 W1000 x 483	95.3 61 500	40.16 1 020	1.000 25.4	15.910 404	1.810 46.0	34.053 865	3.054 78	1.681 43	1.18 30	25600 10 656	1280 20 975	16.4 417	1220 508	153 2 507	3.58 90.9	1460 23 925	239 3 916
	W40 x 297 W1000 x 443	87.4 56 400	39.84 1 012	0.930 23.6	15.825 402	1.650 41.9	34.053 865	2.894 73	1.646 42	1.18 30	23200 9 657	1170 19 173	16.3 414	1090 454	138 2 261	3.54 89.9	1330 21 795	215 3 523
	W40 x 277 W1000 x 412	81.3 52 500	39.69 1 008	0.830 21.1	15.830 402	1.575 40.0	34.053 865	2.819 72	1.596 41	1.18 30	21900 9 115	1100 18 026	16.4 417	1040 433	132 2 163	3.58 90.9	1250 20 484	204 3 343
	W40 x 249 W1000 x 371	73.3 47 300	39.38 1 000	0.750 19.0	15.750 400	1.420 36.1	34.053 865	2.664 68	1.556 40	1.18 30	19600 8 158	993 16 272	16.3 414	926 385	118 1 934	3.55 90.2	1120 18 353	182 2 982
	W40 x 215 W1000 x 321	63.3 40 800	38.98 990	0.650 16.5	15.750 400	1.220 31.0	34.053 865	2.464 63	1.506 38	1.18 30	16700 6 951	859 14 076	16.2 411	796 331	101 1 655	3.54 89.9	964 15 797	156 2 556
	W40 x 199 W1000 x 296	58.4 37 700	38.67 982	0.650 16.5	15.750 400	1.065 27.1	34.053 865	2.309 59	1.506 38	1.18 30	14900 6 202	770 12 618	16.0 406	695 289	88.2 1 445	3.45 87.6	869 14 240	137 2 245
40 x 12 1000 x 300	W40 x 327 W1000 x 486	95.9 61 900	40.79 1 036	1.180 30.0	12.130 308	2.130 54.1	34.043 865	3.374 86	1.771 45	1.18 30	24500 10 198	1200 19 664	16.0 406	640 266	105 1 721	2.58 65.5	1410 23 106	170 2 786
	W40 x 294 W1000 x 438	86.2 55 600	40.39 1 026	1.060 26.9	12.010 305	1.930 49.0	34.043 865	3.174 81	1.711 43	1.18 30	21900 9 115	1080 17 698	15.9 404	562 234	935.0 15 322	2.55 64.8	1270 20 811	150 2 458
	W40 x 264 W1000 x 393	77.6 50 100	40.00 1 016	0.960 24.4	11.930 303	1.730 43.9	34.053 865	2.974 75	1.661 42	1.18 30	19400 8 075	971 15 912	15.8 401	493 205	82.6 1 354	2.52 64.0	1130 18 517	132 2 163
	W40 x 235 W1000 x 350	68.9 44 600	39.69 1 008	0.830 21.1	11.890 302	1.575 40.0	34.053 865	2.819 72	1.596 41	1.18 30	17400 7 242	875 14 339	15.9 404	444 185	74.6 1 222	2.54 64.5	1010 16 551	118 1 934
	W40 x 211 W1000 x 314	62.0 40 000	39.37 1 000	0.750 19.1	11.810 300	1.415 35.9	34.053 865	2.659 67	1.556 40	1.18 30	15500 6 452	786 12 880	15.8 401	390 162	66.1 1 083	2.51 63.8	906 14 847	105 1 721
	W40 x 183 W1000 x 272	53.7 34 600	38.98 990	0.650 16.5	11.810 300	1.200 31.0	34.093 865	2.444 63	1.506 38	1.18 30	13200 5 494	675 11 061	15.7 399	331 138	56.0 918	2.49 63.2	774 12 684	88.3 1 447
	W40 x 167 W1000 x 249	49.1 31 700	38.59 980	0.650 16.5	11.810 300	1.025 26.0	34.053 865	2.269 58	1.506 38	1.18 30	11600 4 828	600 9 832	15.3 389	283 118	47.9 785 6	2.40 61.0	693 11 356	76.0 1 245
	W40 x 149 W1000 x 222	43.8 28 200	38.20 970	0.630 16.0	11.810 300	0.830 21.1	34.053 865	2.074 53	1.496 38	1.18 30	9800 4 079	513 8 407	15.0 381	229 95.3	38.8 636	2.29 58.2	598 9 799	62.2 1 019

WIDE FLANGE BEAMS

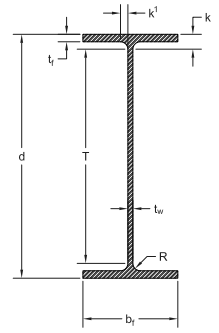

W36 & W920

Prime Section Group	Section Size Inch x lbs/ft (mm x kg/m)	Area A Inch ² (mm ²)	Depth d Inch (mm)	Web Thickness t _w Inch (mm)	Flange		Distance			Fillet Radius R Inch (mm)	Elastic Properties						Plastic Modulus	
					Width b _f Inch (mm)	Thickness t _f Inch (mm)	T Inch (mm)	k Inch (mm)	k' Inch (mm)		X - X			Y - Y			Z _x Inch ³ (10 ³ mm ³)	Z _y Inch ³ (10 ³ mm ³)
											I _x Inch ⁴ (10 ⁶ mm ⁴)	S _x Inch ³ (10 ³ mm ³)	r _x Inch (mm)	I _y Inch ⁴ (10 ⁶ mm ⁴)	S _y Inch ³ (10 ³ mm ³)	r _y Inch (mm)		
36 x 16.5 920 x 420	W36 x 441 W920 x 656	129.7 83 700	38.85 987	1.360 34.5	16.965 431	2.440 62.0	31.483 800	3.684 94	1.861 47	1.18 30	32100 13 361	1650 27 039	15.7 399	1910 795	235 3 851	3.92 99.6	1910 31 299	368 6 030
	W36 x 395 W920 x 588	116.2 75 000	38.37 975	1.220 31.0	16.830 427	2.200 55.9	31.483 800	3.444 87	1.791 46	1.18 30	28500 11 863	1490 24 417	15.7 399	1750 728	208 3 408	3.88 98.6	1710 28 022	325 5 326
	W36 x 361 W920 x 537	106.1 68 500	37.99 965	1.120 28.4	16.730 425	2.010 51.1	31.483 800	3.254 83	1.741 44	1.18 30	25700 10 697	1350 22 122	15.6 396	1570 653	188 3 081	3.85 97.8	1550 25 400	293 4 801
	W36 x 330 W920 x 491	97.0 62 600	37.67 957	1.020 25.9	16.630 422	1.850 47.0	31.483 800	3.094 79	1.691 43	1.18 30	23300 9 698	1240 20 320	15.5 394	1420 591	171 2 802	3.83 97.3	1410 23 106	265 4 343
	W36 x 302 W920 x 449	88.8 57 600	37.33 948	0.945 24.0	16.655 423	1.680 42.7	31.483 800	2.924 74	1.654 42	1.18 30	21100 8 782	1130 18 517	15.4 391	1300 541	156 2 556	3.82 97.0	1280 20 975	241 3 949
	W36 x 282 W920 x 420	82.9 53 500	37.11 943	0.885 22.5	16.595 422	1.570 39.9	31.483 800	2.814 71	1.624 41	1.18 30	19600 8 158	1050 17 206	15.4 391	1200 499	144 2 360	3.80 96.5	1190 19 501	223 3 654
	W36 x 262 W920 x 390	77.0 49 700	36.85 936	0.840 21.3	16.550 420	1.440 36.6	31.483 800	2.684 68	1.601 41	1.18 30	17900 7 451	972 15 928	15.3 389	1090 454	132 2 163	3.76 95.5	1100 18 026	204 3 343
	W36 x 247 W920 x 368	72.5 46 800	36.67 931	0.800 20.3	16.510 419	1.350 34.3	31.483 799	2.594 66	1.581 40	1.18 30	16700 6 951	913 14 961	15.2 386	1010 420	123 2 016	3.74 95.0	1030 16 879	190 3 114
	W36 x 231 W920 x 344	68.0 43 900	36.49 927	0.760 19.3	16.470 418	1.260 32.0	31.483 800	2.504 64	1.561 40	1.18 30	15600 6 493	854 13 994	15.1 384	940 391	114 1 868	3.71 94.2	963 15 781	176 2 884
36 x 12 920 x 300	W36 x 256 W920 x 381	75.4 48 600	37.43 951	0.960 24.4	12.215 310	1.730 43.9	31.483 800	2.974 75	1.661 42	1.18 30	16800 6 993	895 14 666	14.9 378	528 220	86.5 1 417	2.65 67.3	1040 17 042	137 2 245
	W36 x 232 W920 x 345	68.1 44 000	37.12 943	0.870 22.1	12.120 308	1.570 39.9	31.493 800	2.814 71	1.616 41	1.18 30	15000 6 243	809 13 257	14.8 376	468 195	77.2 1 265	2.62 66.5	936 15 338	122 1 999
	W36 x 210 W920 x 313	61.8 39 900	36.69 932	0.830 21.1	12.180 309	1.360 34.5	31.483 800	2.604 66	1.596 41	1.18 30	13200 5 494	719 11 782	14.6 371	411 171	67.5 1 106	2.58 65.5	833 13 650	107 1 753
	W36 x 194 W920 x 289	57.0 36 800	36.49 927	0.765 19.4	12.115 308	1.260 32.0	31.483 800	2.504 64	1.564 40	1.18 30	12100 5 036	664 10 881	14.6 371	375 156	61.9 1 014	2.56 65.0	767 12 569	97.7 1 601
	W36 x 182 W920 x 271	53.6 34 600	36.33 923	0.725 18.4	12.075 307	1.180 30.0	31.483 800	2.424 62	1.544 39	1.18 30	11300 4 703	623 10 209	14.5 368	347 144	57.6 944	2.55 64.8	718 11 766	90.7 1 486
	W36 x 170 W920 x 253	50.0 32 300	36.17 919	0.680 17.3	12.030 306	1.100 27.9	31.483 800	2.344 59	1.521 39	1.18 30	10500 4 370	581 9 521	14.5 368	320 133	53.2 872	2.53 64.3	668 10 947	83.8 1 373
	W36 x 160 W920 x 238	47.0 30 300	36.01 915	0.650 16.5	12.000 305	1.020 25.9	31.483 800	2.264 57	1.506 38	1.18 30	9760 4 062	542 8 882	14.4 366	295 123	49.1 805	2.50 63.5	624 10 225	77.3 1 267
	W36 x 150 W920 x 223	44.2 28 500	35.85 911	0.625 15.9	11.975 304	0.940 23.9	31.483 800	2.184 55	1.494 38	1.18 30	9040 3 763	504 8 259	14.3 363	270 112	45.1 739	2.47 62.7	581 9 521	70.9 1 162
	W36 x 135 W920 x 201	39.7 25 600	35.55 903	0.600 15.2	11.950 304	0.790 20.1	31.483 800	2.034 52	1.481 38	1.18 30	7800 3 247	439 7 194	14.0 356	225 93.7	37.7 618	2.38 60.5	509 8 341	59.7 978

WIDE FLANGE BEAMS

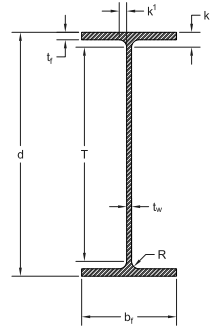

W33 & W840

Prime Section Group	Section Size Inch x lbs/ft (mm x kg/m)	Area A Inch ² (mm ²)	Depth d Inch (mm)	Web Thickness t _w Inch (mm)	Flange		Distance			Fillet Radius R Inch (mm)	Elastic Properties						Plastic Modulus	
					Width b _f Inch (mm)	Thickness t _f Inch (mm)	T Inch (mm)	k Inch (mm)	k' Inch (mm)		X - X			Y - Y			Z _x Inch ³ (10 ³ mm ³)	Z _y Inch ³ (10 ³ mm ³)
											I _x Inch ⁴ (10 ⁶ mm ⁴)	S _x Inch ³ (10 ³ mm ³)	r _x Inch (mm)	I _y Inch ⁴ (10 ⁶ mm ⁴)	S _y Inch ³ (10 ³ mm ³)	r _y Inch (mm)		
33 x 15.75 840 x 400	W33 x 387 W840 x 576	114.0 73 500	35.95 913	1.260 32.0	16.200 411	2.280 57.9	28.903 734	3.524 89	1.811 46	1.18 30	24300 10 114	1350 22 122	14.6 371	1620 674	200 3 277	3.77 95.8	1560 25 564	312 5 113
	W33 x 354 W840 x 527	104.7 67 200	35.55 903	1.160 29.5	16.100 409	2.090 53.1	28.883 734	3.334 85	1.761 45	1.18 30	22000 9 157	1240 20 320	14.5 368	1460 608	181 2 966	3.74 95.0	1420 23 270	282 4 621
	W33 x 318 W840 x 473	93.5 60 300	35.16 893	1.040 26.4	15.985 406	1.890 48.0	28.893 734	3.134 80	1.701 43	1.18 30	19500 8 117	1110 18 190	14.5 368	1290 537	161 2 638	3.71 94.2	1270 20 811	250 4 097
	W33 x 291 W840 x 433	85.6 55 200	34.84 885	0.960 24.4	15.905 404	1.730 43.9	28.893 734	2.974 75	1.661 42	1.18 30	17700 7 367	1020 16 715	14.4 366	1160 483	146 2 393	3.68 93.5	1160 19 009	226 3 703
	W33 x 263 W840 x 392	77.4 49 900	34.53 877	0.870 22.1	15.805 401	1.570 39.9	28.903 734	2.814 71	1.616 41	1.18 30	15900 6 618	919 15 060	14.3 363	1040 433	131 2 147	3.66 93.0	1040 17 042	202 3 310
	W33 x 241 W840 x 359	70.9 45 700	34.18 868	0.830 21.1	15.860 403	1.400 35.6	28.893 734	2.644 67	1.596 41	1.18 30	14200 5 910	831 13 618	14.1 358	933 388	118 1 934	3.62 91.9	940 15 404	182 2 982
	W33 x 221 W840 x 329	65.0 41 900	33.93 862	0.775 19.7	15.805 401	1.275 32.4	28.893 734	2.519 64	1.569 40	1.18 30	12900 5 369	759 12 438	14.1 358	840 350	106 1 737	3.59 91.2	857 14 044	164 2 687
	W33 x 201 W840 x 299	59.1 38 100	33.68 855	0.715 18.2	15.745 400	1.150 29.2	28.893 734	2.394 61	1.539 39	1.18 30	11600 4 828	686 11 241	14.0 356	749 312	95.2 1 560	3.56 90.4	773 12 667	147 2 409
33 x 11.5 840 x 290	W33 x 169 W840 x 251	49.5 31 900	33.82 859	0.670 17.0	11.500 292	1.220 31.0	28.893 734	2.464 63	1.516 39	1.18 30	9290 3 867	549 8 996	13.7 348	310 129	53.9 883	2.50 63.5	629 10 307	84.4 1 383
	W33 x 152 W840 x 226	44.7 28 800	33.49 851	0.635 16.1	11.565 294	1.055 26.8	28.893 734	2.299 58	1.499 38	1.18 30	8160 3 396	487 7 980	13.5 343	273 114	47.2 773	2.47 62.7	559 9 160	73.9 1 211
	W33 x 141 W840 x 210	41.6 26 800	33.30 846	0.605 15.4	11.535 293	0.960 24.4	28.893 734	2.204 56	1.484 38	1.18 30	7450 3 101	448 7 341	13.4 340	246 102	42.7 700	2.43 61.7	514 8 423	66.9 1 096
	W33 x 130 W840 x 193	38.3 24 700	33.09 840	0.580 14.7	11.510 292	0.855 21.7	28.893 734	2.099 53	1.471 37	1.18 30	6710 2 793	406 6 653	13.2 335	218 90.7	37.9 621	2.39 60.7	467 7 653	59.5 975
	W33 x 118 W840 x 176	34.7 22 400	32.86 835	0.550 14.0	11.480 292	0.740 18.8	28.893 734	1.984 50	1.456 37	1.18 30	5900 2 456	359 5 883	13.0 330	187 77.8	32.6 534	2.32 58.9	415 6 801	51.3 841

WIDE FLANGE BEAMS

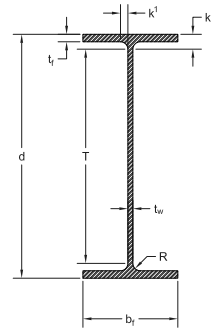

W30 & W760

Prime Section Group	Section Size Inch x lbs/ft (mm x kg/m)	Area A Inch ² (mm ²)	Depth d Inch (mm)	Web Thickness t _w Inch (mm)	Flange		Distance			Fillet Radius R Inch (mm)	Elastic Properties						Plastic Modulus	
					Width b _f Inch (mm)	Thickness t _f Inch (mm)	T Inch (mm)	k Inch (mm)	k' Inch (mm)		X - X			Y - Y			Z _x Inch ³ (10 ³ mm ³)	Z _y Inch ³ (10 ³ mm ³)
											I _x Inch ⁴ (10 ⁶ mm ⁴)	S _x Inch ³ (10 ³ mm ³)	r _x Inch (mm)	I _y Inch ⁴ (10 ⁶ mm ⁴)	S _y Inch ³ (10 ³ mm ³)	r _y Inch (mm)		
30 x 15 760 x 380	W30 x 391 W760 x 582	115.0 74 200	33.19 843	1.360 34.5	15.590 396	2.440 62.0	1.861 47	1.18 30	20700 8 616	1250 20 484	13.4 340	1550 645	198 3 245	3.67 93.2	1450 23 761	310 5 080	1560 25 564	312 5 113
	W30 x 357 W760 x 531	104.8 67 600	32.80 833	1.240 31.5	15.470 393	2.240 56.9	1.801 46	1.18 30	18700 7 784	1140 18 681	13.3 338	1390 579	179 2 933	3.64 92.5	1320 21 631	279 4 572	1420 23 270	282 4 621
	W30 x 326 W760 x 484	95.7 61 700	32.40 823	1.140 29.0	15.370 390	2.050 52.1	1.751 45	1.18 30	16800 6 993	1040 17 042	13.2 335	1240 516	162 2 655	3.60 91.4	1190 19 501	252 4 130	1270 20 811	250 4 097
	W30 x 292 W760 x 434	85.7 55 300	32.01 813	1.020 25.9	15.255 387	1.850 47.0	1.691 43	1.18 30	14900 6 202	930 15 240	13.2 335	1100 458	144 2 360	3.58 90.9	1060 17 370	223 3 654	1160 19 009	226 3 703
	W30 x 261 W760 x 389	76.7 49 500	31.61 803	0.930 23.6	15.155 385	1.650 41.9	1.646 42	1.18 30	13100 5 453	829 13 585	13.1 333	959 399	127 2 081	3.53 89.7	943 15 453	196 3 212	1040 17 042	202 3 310
	W30 x 235 W760 x 350	69.0 44 500	31.30 795	0.830 21.1	15.055 382	1.500 38.1	1.596 41	1.18 30	11700 4 870	748 12 257	13.0 330	855 356	114 1 868	3.51 89.2	847 13 880	175 2 868	940 15 404	182 2 982
	W30 x 211 W760 x 314	62.0 40 000	30.94 786	0.775 19.7	15.105 384	1.315 33.4	1.569 40	1.18 30	10300 4 287	665 10 897	12.9 328	757 315	100 1 639	3.49 88.6	751 12 307	155 2 540	857 14 044	164 2 687
	W30 x 191 W760 x 284	56.1 36 200	30.68 779	0.710 18.0	15.040 382	1.185 30.1	1.536 39	1.18 30	9200 3 829	600 9 832	12.8 325	673 280	89.5 1 467	3.46 87.9	675 11 061	138 2 261	773 12 667	147 2 409
	W30 x 173 W760 x 257	50.8 32 800	30.44 773	0.655 16.6	14.985 381	1.065 27.1	1.509 38	1.18 30	8230 3 426	541 8 865	12.7 323	598 249	79.8 1 308	3.42 86.9	607 9 947	123 2 016	629 10 307	84.4 1 383
30 x 10.5 760 x 270	W30 x 148 W760 x 220	43.5 28 100	30.67 779	0.650 16.5	10.480 266	1.180 30.0	1.506 38	1.18 30	6680 2 780	436 7 145	12.4 315	227 94.5	43.3 710	2.28 57.9	500 8 194	68.0 1 114	559 9 160	73.9 1 211
	W30 x 132 W760 x 196	38.9 25 100	30.31 770	0.615 15.6	10.545 268	1.000 25.4	1.489 38	1.18 30	5770 2 402	380 6 227	12.2 310	196 81.6	37.2 610	2.25 57.2	437 7 161	58.4 957	514 8 423	66.9 1 096
	W30 x 124 W760 x 185	36.5 23 500	30.17 766	0.585 14.9	10.515 267	0.930 23.6	1.474 37	1.18 30	5360 2 231	355 5 817	12.1 307	181 75.3	34.4 564	2.23 56.6	408 6 686	54.0 885	467 7 653	59.5 975
	W30 x 116 W760 x 173	34.2 22 100	30.01 762	0.565 14.4	10.495 267	0.850 21.6	1.464 37	1.18 30	4930 2 052	329 5 391	12.0 305	164 68.3	31.3 513	2.19 55.6	378 6 194	49.2 806	415 6 801	51.3 841
	W30 x 108 W760 x 161	31.7 20 500	29.83 758	0.545 13.8	10.475 266	0.760 19.3	1.454 37	1.18 30	4470 1 861	299 4 900	11.9 302	146 60.8	27.9 457	2.15 54.6	346 5 670	43.9 719	415 6 801	51.3 841
	W30 x 99 W760 x 147	29.1 18 800	29.65 753	0.520 13.2	10.450 265	0.670 17.0	1.441 37	1.18 30	3990 1 661	269 4 408	11.7 297	128 53.3	24.5 401	2.10 53.3	312 5 113	38.6 633	415 6 801	51.3 841
W30 x 90 W760 x 134	26.4 17 000	29.53 750	0.470 11.9	10.400 264	0.610 15.5	1.416 36	1.18 30	3610 1 503	245 4 015	11.7 297	115 47.9	22.1 362	2.09 53.1	283 4 638	34.7 569	415 6 801	51.3 841	

WIDE FLANGE BEAMS

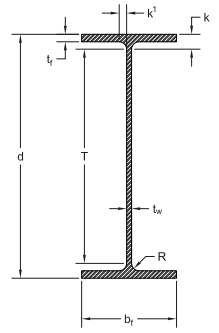

W27 & W690

Prime Section Group	Section Size Inch x lbs/ft (mm x kg/m)	Area A Inch ² (mm ²)	Depth d Inch (mm)	Web Thickness t _w Inch (mm)	Flange		Distance			Fillet Radius R Inch (mm)	Elastic Properties						Plastic Modulus	
					Width b _f Inch (mm)	Thickness t _f Inch (mm)	T Inch (mm)	k Inch (mm)	k' Inch (mm)		X - X			Y - Y			Z _x Inch ³ (10 ³ mm ³)	Z _y Inch ³ (10 ³ mm ³)
											I _x Inch ⁴ (10 ⁶ mm ⁴)	S _x Inch ³ (10 ³ mm ³)	r _x Inch (mm)	I _y Inch ⁴ (10 ⁶ mm ⁴)	S _y Inch ³ (10 ³ mm ³)	r _y Inch (mm)		
27 x 14 690 x 360	W27 x 368 W690 x 548	108.1 69 800	30.39 772	1.380 35.1	14.665 372	2.480 63.0	22.943 583	3.724 95	1.871 48	1.18 30	16200 6 743	1060 17 370	12.2 310	1310 545	179 2 933	3.48 88.4	1240 20 320	279 4 572
	W27 x 336 W690 x 500	98.7 63 700	30.00 762	1.260 32.0	14.550 370	2.280 57.9	22.953 583	3.524 89	1.811 46	1.18 30	14600 6 077	972 15 928	12.1 307	1180 491	162 2 655	3.45 87.6	1130 18 517	252 4 130
	W27 x 307 W690 x 457	90.2 58 200	29.61 752	1.160 29.5	14.445 367	2.090 53.1	22.943 583	3.334 85	1.761 45	1.18 30	13100 5 453	887 14 535	12.0 305	1050 437	146 2 393	3.41 86.6	1030 16 879	227 3 720
	W27 x 281 W690 x 419	82.6 53 300	29.29 744	1.060 26.9	14.350 365	1.930 49.0	22.943 583	3.174 81	1.711 43	1.18 30	11900 4 953	814 13 339	12.0 305	953 397	133 2 179	3.39 86.1	936 15 338	206 3 376
	W27 x 258 W690 x 384	75.7 48 900	28.98 736	0.980 24.9	14.270 362	1.770 45.0	22.953 583	3.014 77	1.671 42	1.18 30	10800 4 495	745 12 208	11.9 302	859 358	120 1 966	3.36 85.3	852 13 962	187 3 064
	W27 x 235 W690 x 350	69.1 44 600	28.66 728	0.910 23.1	14.190 360	1.610 40.9	22.953 583	2.854 72	1.636 42	1.18 30	9700 4 037	677 11 094	11.8 300	769 320	108 1 770	3.33 84.6	772 12 651	168 2 753
	W27 x 217 W690 x 327	63.8 41 100	28.43 722	0.830 21.1	14.115 359	1.500 38.1	22.943 583	2.744 70	1.596 41	1.18 30	8910 3 709	627 10 275	11.8 300	704 293	100.0 1 639	3.32 84.3	711 11 651	154 2 524
	W27 x 194 W690 x 289	57.0 36 800	28.11 714	0.750 19.0	14.035 356	1.340 34.0	22.943 583	2.584 66	1.556 40	1.18 30	7860 3 272	559 9 160	11.7 297	619 258	88.1 1 444	3.29 83.6	631 10 340	136 2 229
	W27 x 178 W690 x 265	52.3 33 700	27.81 706	0.725 18.4	14.085 358	1.190 30.2	22.943 583	2.434 62	1.544 39	1.18 30	7020 2 922	505 8 275	11.6 295	555 231	78.8 1 291	3.25 82.6	570 9 341	122 1 999
	W27 x 161 W690 x 240	47.4 30 600	27.59 701	0.660 16.8	14.020 356	1.080 27.4	22.943 583	2.324 59	1.511 38	1.18 30	6310 2 626	458 7 505	11.5 292	497 207	70.9 1 162	3.23 82.0	515 8 439	109 1 786
	W27 x 146 W690 x 217	42.9 27 700	27.38 695	0.605 15.4	13.965 355	0.975 24.8	22.943 582	2.219 56	1.484 38	1.18 30	5660 2 356	414 6 784	11.5 292	443 184	63.5 1 041	3.20 81.3	464 7 604	97.7 1 601
	27 x 10 690 x 250	W27 x 129 W690 x 192	37.8 24 400	27.63 702	0.610 15.5	10.010 254	1.100 27.9	22.943 583	2.344 59	1.486 38	1.18 30	4760 1 981	345 5 654	11.2 284	184 76.6	36.8 603	2.21 56.1	395 6 473
W27 x 114 W690 x 170		33.5 21 600	27.29 693	0.570 14.5	10.070 256	0.930 23.6	22.943 583	2.174 55	1.466 37	1.18 30	4080 1 698	299 4 900	11.0 279	159 66.2	31.5 516	2.18 55.4	343 5 621	49.3 808
W27 x 102 W690 x 152		30.0 19 400	27.09 688	0.515 13.1	10.015 254	0.830 21.1	22.943 583	2.074 53	1.439 37	1.18 30	3620 1 507	267 4 375	11.0 279	139 57.9	27.8 456	2.15 54.6	305 4 998	43.4 711
W27 x 94 W690 x 140		27.7 17 900	26.92 684	0.490 12.4	9.990 254	0.745 18.9	22.943 583	1.989 50	1.426 36	1.18 30	3270 1 361	243 3 982	10.9 277	124 51.6	24.8 406	2.12 53.8	278 4 556	38.8 636
W27 x 84 W690 x 125		24.8 16 000	26.71 678	0.460 11.7	9.960 253	0.640 16.3	22.943 582	1.884 48	1.411 36	1.18 30	2850 1 186	213 3 490	10.7 272	106 44.1	21.2 347	2.07 52.6	244 3 998	33.2 544

WIDE FLANGE BEAMS

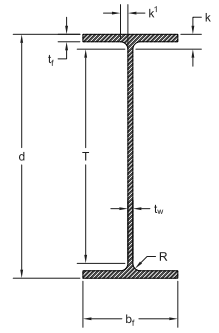

W24 & W610

Prime Section Group	Section Size Inch x lbs/ft (mm x kg/m)	Area A Inch ² (mm ²)	Depth d Inch (mm)	Web Thickness t _w Inch (mm)	Flange		Distance			Fillet Radius R Inch (mm)	Elastic Properties						Plastic Modulus	
					Width b _f Inch (mm)	Thickness t _f Inch (mm)	T Inch (mm)	k Inch (mm)	k' Inch (mm)		X - X			Y - Y			Z _x Inch ³ (10 ³ mm ³)	Z _y Inch ³ (10 ³ mm ³)
											I _x Inch ⁴ (10 ⁶ mm ⁴)	S _x Inch ³ (10 ³ mm ³)	r _x Inch (mm)	I _y Inch ⁴ (10 ⁶ mm ⁴)	S _y Inch ³ (10 ³ mm ³)	r _y Inch (mm)		
24 x 12.75 610 x 320	W24 x 370 W610 x 551	108.0 70 200	27.99 711	1.520 38.6	13.660 347	2.720 69.1	20.063 510	3.964 101	1.941 49	1.18 30	13400 5 577	957 15 682	11.1 282	1160 483	170 2 786	3.27 83.1	1130 18 517	267 4 375
	W24 x 335 W610 x 498	98.4 63 500	27.52 699	1.380 35.1	13.520 343	2.480 63.0	20.073 510	3.724 94	1.871 48	1.18 30	11900 4 953	864 14 158	11.0 279	1030 429	152 2 491	3.23 82.0	1020 16 715	238 3 900
	W24 x 306 W610 x 455	89.8 57 900	27.13 689	1.260 32.0	13.405 340	2.280 57.9	20.083 510	3.524 89	1.811 46	1.18 30	10700 4 454	789 12 929	10.9 277	919 383	137 2 245	3.20 81.3	922 15 109	214 3 507
	W24 x 279 W610 x 415	82.0 52 900	26.73 679	1.160 29.5	13.305 338	2.090 53.1	20.063 510	3.334 85	1.761 45	1.18 30	9600 3 996	718 11 766	10.8 274	823 343	124 2 032	3.17 80.5	835 13 683	193 3 163
	W24 x 250 W610 x 372	73.5 47 400	26.34 669	1.040 26.4	13.185 335	1.890 48.0	20.073 510	3.134 80	1.701 43	1.18 30	8490 3 534	644 10 553	10.7 272	724 301	110 1 803	3.14 79.8	744 12 192	171 2 802
	W24 x 229 W610 x 341	67.2 43 400	26.02 661	0.960 24.4	13.110 333	1.730 43.9	20.073 510	2.974 75	1.661 42	1.18 30	7650 3 184	588 9 636	10.7 272	651 271	99.4 1 629	3.11 79.0	675 11 061	154 2 524
	W24 x 207 W610 x 307	60.7 39 100	25.71 653	0.870 22.1	13.010 330	1.570 39.9	20.083 510	2.814 71	1.616 41	1.18 30	6820 2 839	531 8 701	10.6 269	578 241	88.8 1 455	3.08 78.2	606 9 931	137 2 245
	W24 x 192 W610 x 285	56.3 36 100	25.47 647	0.810 20.6	12.950 329	1.460 37.1	20.063 510	2.704 69	1.586 40	1.18 30	6260 2 606	491 8 046	10.5 267	530 221	81.8 1 340	3.07 78.0	559 9 160	126 2 065
	W24 x 176 W610 x 262	51.7 33 300	25.24 641	0.750 19.0	12.890 327	1.340 34.0	20.073 510	2.584 66	1.556 40	1.18 30	5680 2 364	450 7 374	10.5 267	479 199	74.3 1 218	3.04 77.2	511 8 374	115 1 885
	W24 x 162 W610 x 241	47.7 30 800	25.00 635	0.705 17.9	12.955 329	1.220 31.0	20.073 510	2.464 63	1.534 39	1.18 30	5170 2 152	414 6 784	10.4 264	443 184	68.4 1 121	3.05 77.5	468 7 669	105 1 721
	W24 x 146 W610 x 217	43.0 27 700	24.74 628	0.650 16.5	12.900 328	1.090 27.7	20.073 510	2.334 59	1.506 38	1.18 30	4580 1 906	371 6 080	10.3 262	391 163	60.5 991	3.01 76.5	418 6 850	93.2 1 527
	W24 x 131 W610 x 195	38.5 24 800	24.48 622	0.605 15.4	12.855 327	0.960 24.4	20.073 510	2.204 56	1.484 38	1.18 30	4020 1 673	329 5 391	10.2 259	340 142	53.0 869	2.97 75.4	370 6 063	81.5 1 336
	W24 x 117 W610 x 174	34.4 22 200	24.26 616	0.550 14.0	12.800 325	0.850 21.6	20.073 510	2.094 53	1.456 37	1.18 30	3540 1 473	291 4 769	10.1 257	297 124	46.5 762	2.94 74.7	327 5 359	71.4 1 170
	W24 x 104 W610 x 155	30.6 19 700	24.06 611	0.500 12.7	12.750 324	0.750 19.0	20.073 510	1.994 51	1.431 36	1.18 30	3100 1 290	258 4 228	10.1 257	259 108	40.7 667	2.91 73.9	289 4 736	62.4 1 023
	24 x 9 610 x 230	W24 x 103 W610 x 153	30.3 19 600	24.53 623	0.550 14.0	9.000 229	0.980 24.9	20.083 510	2.224 56	1.456 37	1.18 30	3000 1 249	245 4 015	10.00 254	119 49.5	26.5 434	1.99 50.5	280 4 588
W24 x 94 W610 x 140		27.7 17 900	24.31 617	0.515 13.1	9.065 230	0.875 22.2	20.073 510	2.119 54	1.439 37	1.18 30	2700 1 124	222 3 638	9.87 251	109 45.4	24.0 393	1.98 50.3	254 4 162	37.5 615
W24 x 84 W610 x 125		24.7 15 900	24.10 612	0.470 11.9	9.020 229	0.770 19.6	20.073 510	2.014 51	1.416 36	1.18 30	2370 986	196 3 212	9.79 249	94.4 39.3	20.9 342	1.95 49.5	224 3 671	32.6 534
W24 x 76 W610 x 113		22.4 14 500	23.92 608	0.440 11.2	8.990 228	0.680 17.3	20.073 510	1.924 49	1.401 36	1.18 30	2100 874	176 2 884	9.69 246	82.5 34.3	18.4 302	1.92 48.8	200 3 277	28.6 469
W24 x 68 W610 x 101		20.1 13 000	23.73 603	0.415 10.5	8.965 228	0.585 14.9	20.073 510	1.829 46	1.389 35	1.18 30	1830 762	154 2 524	9.55 243	70.4 29.3	15.7 257	1.87 47.5	177 2 900	24.5 401
CSA	W24 x 61 W610 x 91	18.0 11 600	23.56 598	0.380 9.7	8.930 227	0.500 12.7	20.073 510	1.744 44	1.371 35	1.18 30	1602 667	136 2 230	9.45 240	59.6 219	13.4 46.3	1.82 46.3	156 2 560	20.9 343
	W24 x 56 W610 x 84	16.6 10 700	23.48 596	0.355 9.0	8.900 226	0.460 11.7	20.073 510	1.704 43	1.359 35	1.18 30	1473 613	126 2 060	9.41 239	54.3 22.6	12.2 200	1.81 45.9	144 2 360	19.1 313
24 x 7 610 x 180	W24 x 62 W610 x 92	18.2 11 700	23.74 603	0.430 10.9	7.040 179	0.590 15.0	20.939 532	1.401 36	0.963 24	0.75 19	1550 645	131 2 147	9.23 234	34.5 14.4	9.8 161	1.38 35.1	153 2 507	15.7 257
	W24 x 55 W610 x 82	16.2 10 500	23.57 599	0.395 10.0	7.005 178	0.505 12.8	20.939 532	1.316 33	0.946 24	0.75 19	1350 562	114 1 868	9.11 231	29.1 12.1	8.30 136	1.34 34.0	134 2 196	13.3 218

WIDE FLANGE BEAMS

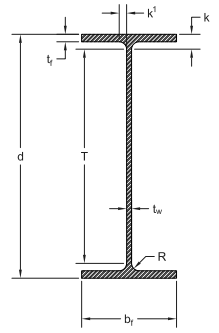

W21 & W530

Prime Section Group	Section Size Inch x lbs/ft (mm x kg/m)	Area A Inch ² (mm ²)	Depth d Inch (mm)	Web Thickness t _w Inch (mm)	Flange		Distance			Fillet Radius R Inch (mm)	Elastic Properties						Plastic Modulus		
					Width b _f Inch (mm)	Thickness t _f Inch (mm)	T Inch (mm)	k Inch (mm)	k' Inch (mm)		X - X			Y - Y			Z _x Inch ³ (10 ³ mm ³)	Z _y Inch ³ (10 ³ mm ³)	
											I _x Inch ⁴ (10 ⁶ mm ⁴)	S _x Inch ³ (10 ³ mm ³)	r _x Inch (mm)	I _y Inch ⁴ (10 ⁶ mm ⁴)	S _y Inch ³ (10 ³ mm ³)	r _y Inch (mm)			
21 x 13 530 x 330	W21 x 275* W530 x 409*	81.8 52 700	24.13 613	1.220 31.0	12.890 327	2.190 55.6	17.263 439	3.434 87	1.791 45	1.18 30	7710 3 210	639 10 500	9.71 247	786 327	122 2 000	3.10 78.7	750 12 300	190 3 120	
	W21 x 248* W530 x 369*	73.8 47 600	23.74 603	1.100 27.9	12.775 324	1.990 50.5	17.273 439	3.234 82	1.731 44	1.18 30	6850 2 850	577 9 450	9.63 245	695 289	109 1 780	3.07 77.9	672 11 000	169 2 770	
	W21 x 223* W530 x 332*	66.3 42 800	23.35 593	1.000 25.4	12.675 322	1.790 45.5	17.283 439	3.034 77	1.681 43	1.18 30	6040 2 510	517 8 480	9.54 242	610 254	96.2 1 580	3.03 77.0	598 9 800	150 2 450	
21 x 12.25 530 x 310	W21 x 201 W530 x 300	59.2 38 200	23.03 585	0.910 23.1	12.575 319	1.630 41.4	17.283 439	2.874 73	1.636 42	1.18 30	5310 2 210	461 7 554	9.47 241	542 226	86.1 1 411	3.02 76.7	530 8 685	133 2 179	
	W21 x 182 W530 x 272	53.7 34 600	22.72 577	0.830 21.1	12.500 317	1.480 37.6	17.273 439	2.724 69	1.596 41	1.18 30	4730 1 969	417 6 833	9.40 239	483 201	77.2 1 265	3.00 76.2	476 7 800	119 1 950	
	W21 x 166 W530 x 248	48.9 31 500	22.48 571	0.750 19.0	12.420 315	1.360 34.5	17.273 439	2.604 66	1.556 40	1.18 30	4280 1 781	380 6 227	9.36 238	435 181	70.0 1 147	2.99 75.9	432 7 079	108 1 770	
	W21 x 147 W530 x 219	43.2 27 900	22.06 560	0.720 18.3	12.510 318	1.150 29.2	17.273 439	2.394 61	1.541 39	1.18 30	3630 1 511	329 5 391	9.17 233	376 157	60.1 985	2.95 74.9	373 6 112	92.6 1 517	
	W21 x 132 W530 x 196	38.8 25 000	21.83 554	0.650 16.5	12.440 316	1.035 26.3	17.273 438	2.279 58	1.506 38	1.18 30	3220 1 340	295 4 834	9.12 232	333 139	53.5 877	2.93 74.4	333 5 457	82.3 1 349	
	W21 x 122 W530 x 182	35.9 23 200	21.68 551	0.600 15.2	12.390 315	0.960 24.4	17.273 439	2.204 56	1.481 38	1.18 30	2960 1 232	273 4 474	9.09 231	305 127	49.2 806	2.92 74.2	307 5 031	75.6 1 239	
	W21 x 111 W530 x 165	32.7 21 100	21.51 546	0.550 14.0	12.340 313	0.875 22.2	17.273 439	2.119 54	1.456 37	1.18 30	2670 1 111	249 4 080	9.05 230	274 114	44.5 729	2.90 73.7	279 4 572	68.2 1 118	
	W21 x 101 W530 x 150	29.8 19 200	21.36 543	0.500 12.7	12.290 312	0.800 20.3	17.273 439	2.044 52	1.431 36	1.18 30	2420 1 007	227 3 720	9.02 229	248 103	40.3 660	2.89 73.4	253 4 146	61.7 1 011	
	21 x 8.25 530 x 210	W21 x 93 W530 x 138	27.3 17 600	21.62 549	0.580 14.7	8.420 214	0.930 23.6	18.139 461	1.741 44	1.038 26	0.75 19	2070 862	192 3 146	8.70 221	92.9 39	22.1 362	1.84 46.7	221 3 622	34.7 569
		W21 x 83 W530 x 123	24.3 15 700	21.43 544	0.515 13.1	8.355 212	0.835 21.2	18.139 461	1.646 42	1.006 26	0.75 19	1830 762	171 2 802	8.67 220	81.4 34	19.5 320	1.83 46.5	196 3 212	30.5 500
W21 x 73 W530 x 109		21.5 13 900	21.24 539	0.455 11.6	8.295 211	0.740 18.8	18.139 460	1.551 39	0.976 25	0.75 19	1600 666	151 2 474	8.64 219	70.6 29	17.0 279	1.81 46.0	172 2 819	26.6 436	
W21 x 68 W530 x 101		20.0 12 900	21.13 537	0.430 10.9	8.270 210	0.685 17.4	18.139 461	1.496 38	0.963 24	0.75 19	1480 616	140 2 294	8.60 218	64.7 27	15.7 257	1.80 45.7	160 2 622	24.4 400	
W21 x 62 W530 x 92		18.3 11 800	20.99 533	0.400 10.2	8.240 209	0.615 15.6	18.139 461	1.426 36	0.948 24	0.75 19	1330 554	127 2 081	8.54 217	57.5 24	14.0 229	1.77 45.0	144 2 360	21.7 356	
W21 x 55 W530 x 82		16.2 10 500	20.80 528	0.375 9.5	8.220 209	0.522 13.3	18.135 460	1.333 34	0.936 24	0.75 19	1140 475	110 1 803	8.40 213	48.4 20	11.8 193	1.73 43.9	126 2 065	18.4 302	
W21 x 48 W530 x 72		14.1 9 180	20.62 524	0.350 9.0	8.140 207	0.430 10.9	18.139 461	1.241 31	0.923 23	0.75 19	959 399	93 1 524	8.24 209	38.7 16	9.52 156	1.66 42.2	107 1 753	14.9 244	
21 x 6.5 530 x 170	W21 x 57 W530 x 85	16.7 10 800	21.06 535	0.405 10.3	6.555 166	0.650 16.5	18.139 461	1.461 37	0.951 24	0.75 19	1170 487	111 1 819	8.36 212	30.6 13	9.35 153	1.35 34.3	129 2 114	14.8 243	
	W21 x 50 W530 x 74	14.7 9 480	20.83 529	0.380 9.7	6.530 166	0.535 13.6	18.139 461	1.346 34	0.938 24	0.75 19	984 410	94.5 1 549	8.18 208	24.9 10	7.64 125	1.30 33.0	110 1 803	12.2 200	
	W21 x 44 W530 x 66	13.0 8 390	20.66 525	0.350 8.9	6.500 165	0.450 11.4	18.139 461	1.261 32	0.923 23	0.75 19	843 351	81.6 1 337	8.06 205	20.7 9	6.37 104	1.26 32.0	95.4 1 563	10.2 167	

* Non ASTM A6 Sections

WIDE FLANGE BEAMS

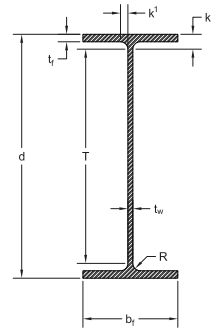

W18 & W460

Prime Section Group	Section Size Inch x lbs/ft (mm x kg/m)	Area A Inch ² (mm ²)	Depth d Inch (mm)	Web Thickness t _w Inch (mm)	Flange		Distance			Fillet Radius R Inch (mm)	Elastic Properties						Plastic Modulus	
					Width b _f Inch (mm)	Thickness t _f Inch (mm)	T Inch (mm)	k Inch (mm)	k' Inch (mm)		X - X			Y - Y			Z _x Inch ³ (10 ³ mm ³)	Z _y Inch ³ (10 ³ mm ³)
											I _x Inch ⁴ (10 ⁶ mm ⁴)	S _x Inch ³ (10 ³ mm ³)	r _x Inch (mm)	I _y Inch ⁴ (10 ⁶ mm ⁴)	S _y Inch ³ (10 ³ mm ³)	r _y Inch (mm)		
18 x 11 460 x 280	W18 x 234	68.8	21.06	1.16	11.65	2.11	15.502	2.779	1.249	0.669	4900	466	8.44	558	95.8	2.85	549	149
	W460x349	44384.944	534.9	29.5	295.9	53.6	393.8	70.6	31.7	17.0	203951.72	7636.342	214.4	23225.5224	1569.8746	72.39	8996.463	2441.663
	W18x211	62.3	20.7	1.06	11.6	1.91	15.5	2.31	1.375	0.669	4330	419	8.35	493	85.3	2.82	409	132
	W460x315	40191.599	525.8	26.9	294.6	48.5	393.7	58.7	34.9	17.0	180226.724	6866.153	212.09	20520.0404	1397.8111	71.628	6702.283	2163.084
	W18x192	56.2	20.4	0.96	11.5	1.75	15.5	2.15	1.125	0.669	3870	380	8.28	440	76.8	2.79	442	119
	W460x286	36256.306	518.2	24.4	292.1	44.5	393.7	54.6	28.6	17.0	161080.236	6227.06	210.312	18314.032	1258.5216	70.866	7243.054	1950.053
	W18x175	51.4	20	0.89	11.4	1.59	15.125	1.99	1.25	0.669	3450	344	8.2	391	68.8	2.76	398	106
	W460x260	33159.682	508.0	22.6	289.6	40.4	384.2	50.5	31.8	17.0	143598.66	5637.128	208.28	16274.5148	1127.4256	70.104	6522.026	1737.022
	W18x158	46.3	19.7	0.81	11.3	1.44	15.125	1.84	1.25	0.669	3060	310	8.12	347	61.4	2.74	356	94.8
	W460x235	29869.519	500.4	20.6	287.0	36.6	384.2	46.7	31.8	17.0	127365.768	5079.97	206.248	14443.1116	1006.1618	69.596	5833.772	1553.4876
	W18x143	42	19.5	0.73	11.2	1.32	15.125	1.72	1.1875	0.669	2750	282	8.09	311	55.5	2.72	322	85.4
	W460x213	27095.46	495.3	18.5	284.5	33.5	384.2	43.7	30.2	17.0	114462.7	4621.134	205.486	12944.6908	909.4785	69.088	5276.614	1399.4498
	W18x130	38.3	19.3	0.67	11.2	1.2	15.125	1.6	1.1875	0.669	2460	256	8.03	278	49.9	2.70	290	76.7
	W460x193	24708.479	490.2	17.0	284.5	30.5	384.2	40.6	30.2	17.0	102392.088	4195.072	203.962	11571.1384	817.7113	68.58	4752.23	1256.8829
	W18x119	35.1	19	0.655	11.3	1.06	15.125	1.46	1.1875	0.669	2190	231	7.9	253	44.9	2.69	262	69.1
	W460x177	22644.063	482.6	16.6	287.0	26.9	384.2	37.1	30.2	17.0	91153.932	3785.397	200.66	10530.5684	735.7763	68.326	4293.394	1132.3417
	W18x106	31.1	18.7	0.59	11.2	0.940	15.125	1.34	1.125	0.669	1910	204	7.84	220	39.4	2.66	230	60.5
	W460x158	20063.543	475.0	15.0	284.5	23.9	384.2	34.0	28.6	17.0	79499.548	3342.948	199.136	9157.016	645.6478	67.564	3769.01	991.4135
W18x97	28.5	18.6	0.535	11.1	0.870	15.125	1.27	1.125	0.669	1750	188	7.82	201	36.1	2.65	211	55.3	
W460x144	18386.205	472.4	13.6	281.9	22.1	384.2	32.3	28.6	17.0	72839.9	3080.756	198.628	8366.1828	591.5707	67.31	3457.657	906.2011	
W18x86	25.3	18.4	0.48	11.1	0.770	15.125	1.17	1.0625	0.669	1530	166	7.77	175	31.6	2.63	186	48.4	
W460x128	16321.789	467.4	12.2	281.9	19.6	384.2	29.7	27.0	17.0	63682.884	2720.242	197.358	7283.99	517.8292	66.802	3047.982	793.1308	
W18x76	22.3	18.2	0.425	11.0	0.680	15.125	1.1	1.1	0.669	1330.0	146.0	7.73	152.0	27.6	2.61	163.0	42.2	
W460x113	14386.399	462.3	10.8	279.4	17.3	384.2	27.4	27.0	17.0	55358.324	2392.502	196.342	6326.6656	452.2812	66.294	2671.081	691.5314	
18 x 75 460 x 190	W18 x 71	20.8	18.47	0.495	7.635	0.81	15.125	1.21	0.875	0.669	1170	127	7.50	60.3	15.8	1.70	146	24.7
	W460x106	13418.704	469.1	12.6	193.9	20.6	384.2	30.7	22.2	17.0	48698.676	2081.149	190.5	2509.85484	258.9146	43.18	2392.502	404.7589
	W18x65	19.1	18.35	0.450	7.59	0.75	15.125	1.15	0.875	0.669	1070	117	7.49	54.8	14.4	1.69	133	22.5
	W460x106	12321.983	466.1	11.4	192.8	19.1	384.2	29.2	22.2	17.0	44536.396	1917.279	190.246	2280.92944	235.9728	42.926	2179.471	368.7075
	W18x60	17.6	18.24	0.415	7.555	0.695	15.125	1.1	0.8125	0.669	984	108	7.47	50.1	13.3	1.68	123	20.6
	W460x106	11354.288	463.3	10.5	191.9	17.7	384.2	27.9	20.6	17.0	40956.8352	1769.796	189.738	2085.30228	217.9471	42.672	2015.601	337.5722
	W18x55	16.2	18.11	0.390	7.53	0.63	15.125	1.03	0.8125	0.669	890	98.3	7.41	44.9	11.9	1.67	112	18.5
W460x106	10451.106	460.0	9.9	191.3	16.0	384.2	26.2	20.6	17.0	37044.292	1610.8421	188.214	1868.86372	195.0053	42.418	1835.344	303.1595	
W18x50	14.7	17.99	0.355	7.495	0.57	15.125	0.972	0.8125	0.669	800	88.9	7.38	40.1	10.7	1.65	101	16.6	
W460x106	9483.411	456.9	9.0	190.4	14.5	384.2	24.7	20.6	17.0	33298.24	1456.8043	187.452	1669.07428	175.3409	41.91	1655.087	272.0242	
18 x 6 460 x 150	W18x46	13.5	18.06	0.360	6.06	0.605	15.125	1.01	0.8125	0.669	712	78.8	7.25	22.5	7.43	1.29	90.7	11.7
	W460x106	8709.255	458.7	9.1	153.9	15.4	384.2	25.7	20.6	17.0	29635.4336	1291.2956	184.15	936.513	121.75541	32.766	1486.3009	191.7279
	W18x40	11.8	17.9	0.315	6.015	0.525	15.125	0.927	0.8125	0.669	612	68.4	7.21	19.1	6.35	1.27	78.4	10
	W460x106	7612.534	454.7	8.0	152.8	13.3	384.2	23.5	20.6	17.0	25473.1536	1120.8708	183.134	794.99548	104.05745	32.258	1284.7408	163.87
W18x35	10.3	17.7	0.300	6	0.425	15.512	0.827	0.75	0.669	510	57.6	7.04	15.3	5.12	1.22	66.5	8.06	
W460x106	6644.839	449.6	7.6	152.4	10.8	394.0	21.0	19.1	17.0	21227.628	943.8912	178.816	636.82884	83.90144	30.988	1089.7355	132.07922	

WIDE FLANGE BEAMS

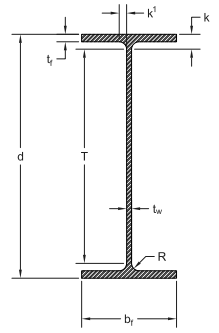

W16 & W410

Prime Section Group	Section Size Inch x lbs/ft (mm x kg/m)	Area A Inch ² (mm ²)	Depth d Inch (mm)	Web Thickness t _w Inch (mm)	Flange		Distance			Fillet Radius R Inch (mm)	Elastic Properties						Plastic Modulus	
					Width b _f Inch (mm)	Thickness t _f Inch (mm)	T Inch (mm)	k Inch (mm)	k' Inch (mm)		X - X			Y - Y			Z _x Inch ³ (10 ³ mm ³)	Z _y Inch ³ (10 ³ mm ³)
											I _x Inch ⁴ (10 ⁶ mm ⁴)	S _x Inch ³ (10 ³ mm ³)	r _x Inch (mm)	I _y Inch ⁴ (10 ⁶ mm ⁴)	S _y Inch ³ (10 ³ mm ³)	r _y Inch (mm)		
16 x 10.25 410 x 260	W16 x 100	29.4	16.97	0.585	10.425	0.985	13.25	1.39	1.125	0.669	1490	175	7.1	186	35.7	2.51	198	54.9
	W410x149	18967	431	15	265	25	337	35	29	17	62018	2868	180	7742	585	64	3245	900
	W16x89	26.2	16.75	0.525	10.365	0.875	13.25	1.28	1.0625	0.669	1300	155	7.05	163	31.4	2.49	175	48.1
	W410x132	16902	425	13	263	22	337	33	27	17	54110	2540	179	6785	515	63	2868	788
	W16x77	22.6	16.52	0.455	10.295	0.76	13.25	1.16	1.0625	0.669	1110	134	7	138	26.9	2.47	150	41.1
	W410x114	14580	420	12	261	19	337	29	27	17	46201	2196	178	5744	441	63	2458	674
16 x 7 410 x 190	W16x67	19.7	16.33	0.395	10.235	0.665	13.25	1.07	1	0.669	954	117	6.96	119	23.2	2.46	130	35.5
	W410x100	12709	415	10	260	17	337	27	25	17	39708	1917	177	4953	380	62	2130	582
	W16 x 57	16.8	16.43	0.43	7.12	0.715	13.625	1.12	0.875	0.669	758	92.2	6.72	43.1	12.1	1.6	105	18.9
	W410x85	10838	417	11	181	18	346	28	22	17	31550	1511	171	1794	198	41	1721	310
	W16x50	14.7	16.26	0.38	7.07	0.63	13.625	1.03	0.8125	0.669	659	81	6.68	37.2	10.5	1.59	92	16.3
	W410x75	9483	413	10	180	16	346	26	21	17	27429	1327	170	1548	172	40	1508	267
16 x 5.5 410 x 140	W16x45	13.3	16.13	0.345	7.035	0.565	13.625	0.967	0.8125	0.669	586	72.7	6.65	32.8	9.34	1.57	82.3	14.5
	W410x67	8580	410	9	179	14	346	25	21	17	24391	1191	169	1365	153	40	1349	238
	W16x40	11.8	16.01	0.305	6.995	0.505	13.625	0.907	0.8125	0.669	518	64.7	6.63	28.9	8.25	1.57	73	12.7
	W410x60	7613	407	8	178	13	346	23	21	17	21561	1060	168	1203	135	40	1196	208
	W16x36	10.6	15.86	0.295	6.985	0.43	13.625	0.832	0.75	0.669	448	56.5	6.51	24.5	7	1.52	64	10.8
	W410x53	6838	403	7	177	11	346	21	19	17	18647	926	165	1020	115	39	1049	177
16 x 5.5 410 x 140	W16x31	9.12	15.88	0.275	5.525	0.44	13.625	0.842	0.75	0.669	375	47.2	6.41	12.4	4.49	1.17	54	7.03
	W410x46.1	5884	403	7	140	11	346	21	19	17	15609	773	163	516	74	30	885	115
	W16x26	7.68	15.69	0.25	5.5	0.345	13.625	0.747	0.75	0.669	301	38.4	6.26	9.59	3.49	1.12	44.2	5.48
W410x38.8	4955	399	6	140	9	346	19	19	17	12528	629	159	399	57	28	724	90	

WIDE FLANGE BEAMS

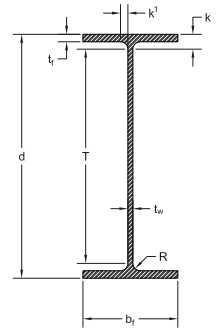

W14 & W360

Prime Section Group	Section Size Inch x lbs/ft (mm x kg/m)	Area A Inch ² (mm ²)	Depth d Inch (mm)	Web Thickness t _w Inch (mm)	Flange		Distance			Fillet Radius R Inch (mm)	Elastic Properties						Plastic Modulus	
					Width b _f Inch (mm)	Thickness t _f Inch (mm)	T Inch (mm)	k Inch (mm)	k' Inch (mm)		X - X			Y - Y			Z _x Inch ³ (10 ³ mm ³)	Z _y Inch ³ (10 ³ mm ³)
											I _x Inch ⁴ (10 ⁶ mm ⁴)	S _x Inch ³ (10 ³ mm ³)	r _x Inch (mm)	I _y Inch ⁴ (10 ⁶ mm ⁴)	S _y Inch ³ (10 ³ mm ³)	r _y Inch (mm)		
14 x 16 360 x 406	W14x283	83.3	16.74	1.29	16.11	2.07	10	2.67	1.875	0.787	3840	459	6.79	1440	179	4.17	179	274
	W360x421	53739	425	33	409	53	254	68	48	20	159832	7522	172	59937	2933	106	2933	4490
	W14x257	75.6	16.38	1.175	15.995	1.89	10	2.49	1.8125	0.787	3400	415	6.71	1290	161	4.13	161	246
	W360x382	48772	416	30	406	48	254	63	46	20	141518	6801	170	53693	2638	105	2638	4031
	W14x233	68.5	16.04	1.070	15.89	1.72	10	2.32	1.75	0.787	3010	375	6.63	1150	145	4.1	145	221
	W360x247	44191	407	27	404	44	254	59	44	20	125285	6145	168	47866	2376	104	2376	3622
	W14x211	62	15.72	0.980	15.8	1.56	10	2.16	1.6875	0.787	2660	338	6.55	1030	130	4.07	130	198
	W360x314	39998	399	25	401	40	254	55	43	20	110717	5539	166	42871	2130	103	2130	3245
	W14x193	56.8	15.48	0.890	15.71	1.44	10	2.04	1.6875	0.787	2400	310	6.50	931	119	4.05	119	180
	W360x287	36643	393	23	399	37	254	52	43	20	99895	5080	165	38751	1950	103	1950	2950
	W14x176	51.8	15.22	0.830	15.65	1.31	10	1.91	1.625	0.787	2140	281	6.43	838	107	4.02	107	163
	W360x262	33418	387	21	398	33	254	49	41	20	89073	4605	163	34880	1753	102	1753	2671
W14x159	46.7	14.98	0.745	15.565	1.19	10	1.79	1.5625	0.787	1900	254	6.38	748	96.2	4	96.2	146	
W360x237	30128	380	19	395	30	254	45	40	20	79083	4162	162	31134	1576	102	1576	2393	
W14x145	42.7	14.78	0.68	15.5	1.09	10	1.69	1.5625	0.787	1710	232	6.33	677	87.3	3.98	87.3	133	
W360x216	27547	375	17	394	28	254	43	40	20	71175	3802	161	28179	1431	101	1431	2179	
14 x 14.5 360 x 370	W14x132	38.8	14.66	0.645	14.725	1.03	10	1.63	1.5625	0.787	1530	209	6.28	548	74.5	3.76	234	113
	W360x196	25031	372	16	374	26	254	41	40	20	63683	3425	160	22809	1221	96	3835	1852
	W14x120	35.3	14.48	0.590	14.670	0.94	10	1.54	1.5	0.787	1380	190	6.24	495	67.5	3.74	212	102
	W360x179	22773	368	15	373	24	254	39	38	20	57439	3114	158	20603	1106	95	3474	1671
	W14x109	32	14.32	0.525	14.605	0.86	10	1.46	1.5	0.787	1240	173	6.22	447	61.2	3.73	192	92.7
	W360x162	20644	364	13	371	22	254	37	38	20	51612	2835	158	18605	1003	95	3146	1519
	W14x99	29.1	14.16	0.485	14.565	0.78	10	1.38	1.4375	0.787	1110	157	6.17	402	55.2	3.71	173	83.6
W360x147	18773	360	12	370	20	254	35	37	20	46201	2573	157	16732	905	94	2835	1370	
W14x90	26.5	14.02	0.440	14.520	0.71	10	1.31	1.4375	0.787	999	143	6.14	362	49.9	3.7	157	75.6	
W360x134	17096	356	11	369	18	254	33	37	20	41581	2343	156	15067	818	94	2573	1239	
14 x 10 360 x 250	W14x82	24.1	14.31	0.510	10.130	0.855	10.875	1.45	1.0625	0.787	881	123	6.05	148	29.3	2.48	139	44.8
	W360x122	15548	363	13	257	22	276	37	27	20	36670	2016	154	6160	480	63	2278	734
	W14x74	21.8	14.17	0.450	10.070	0.785	10.875	1.38	1.0625	0.787	795	112	6.04	134	26.6	2.48	126	40.5
	W360x110	14064	360	11	256	20	276	35	27	20	33090	1835	153	5577	436	63	2065	664
	W14x68	20	14.04	0.415	10.035	0.72	10.875	1.31	1.0625	0.787	722	103	6.01	121	24.2	2.46	115	36.9
	W360x101	12903	357	11	255	18	276	33	27	20	30052	1688	153	5036	397	62	1885	605
W14x61	17.9	13.89	0.375	9.995	0.645	10.875	1.24	1.000	0.787	640	92.1	5.98	107	21.5	2.45	102	32.8	
W360x91	11548	353	10	254	16	276	31	25	20	26639	1509	152	4454	352	62	1671	537	
14 x 8 360 x 200	W14x53	15.6	13.92	0.370	8.060	0.66	10.875	1.25	1.000	0.787	541	77.8	5.89	57.7	14.3	1.92	87.1	22
	W360x79	10064	354	9	205	17	276	32	25	20	22518	1275	150	2402	234	49	1427	361
	W14x48	14.1	13.79	0.340	8.030	0.595	10.875	1.19	1.000	0.787	484	70.2	5.85	51.4	12.8	1.91	78.4	19.6
	W360x72	9096	350	9	204	15	276	30	25	20	20145	1150	149	2139	210	49	1285	321
W14x43	12.6	13.66	0.305	7.995	0.53	10.875	1.12	1.000	0.787	428	62.6	5.82	45.2	11.3	1.89	69.6	17.3	
W360x64	8129	347	8	203	13	276	28	25	20	17815	1026	148	1881	185	48	1141	283	
14 x 6.75 360 x 170	W14x38	11.2	14.1	0.310	6.770	0.515	11.625	0.915	0.8125	0.400	385	54.6	5.87	26.7	7.88	1.55	61.5	12.1
	W360x58	7225	358	8	172	13	295	23	21	10	16025	895	149	1111	129	39	1008	198
	W14x34	10	13.98	0.285	6.745	0.455	11.625	0.855	0.750	0.400	340	48.6	5.83	23.3	6.91	1.53	54.6	10.6
	W360x51	6451	355	7	171	12	295	22	19	10	14152	796	148	970	113	39	895	174
W14x30	8.85	13.84	0.270	6.730	0.385	11.625	0.785	0.750	0.400	291	42	5.73	19.6	5.82	1.49	47.3	8.99	
W360x44.6	5709	352	7	171	10	295	20	19	10	12112	688	146	816	95	38	775	147	
14 x 5 360 x 130	W14x26	7.69	13.91	0.255	5.025	0.42	11.625	0.820	0.750	0.400	245	35.3	5.65	8.91	3.55	1.08	40.2	5.54
	W360x39	4961	353	6	128	11	295	21	19	10	10198	578	144	371	58	27	659	91
	W14x22	6.49	13.74	0.230	5.000	0.335	11.625	0.735	0.750	0.400	199	29	5.54	7.00	2.8	1.05	33.2	4.39
W360x32.9	4187	349	6	127	9	295	19	19	10	8283	475	141	291	46	27	544	72	

WIDE FLANGE BEAMS

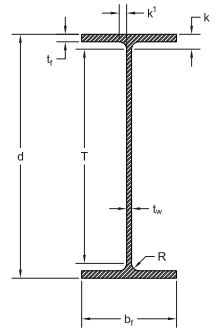

W12 & W310

Prime Section Group	Section Size Inch x lbs/ft (mm x Kg/m)	Area A Inch ² (mm ²)	Depth d Inch (mm)	Web Thickness t _w Inch (mm)	Flange		Distance			Fillet Radius R Inch (mm)	Elastic Properties						Plastic Modulus	
					Width b _f Inch (mm)	Thickness t _f Inch (mm)	T Inch (mm)	k Inch (mm)	k' Inch (mm)		X - X			Y - Y			Z _x Inch ³ (10 ³ mm ³)	Z _y Inch ³ (10 ³ mm ³)
											I _x Inch ⁴ (10 ² mm ⁴)	S _x Inch ³ (10 ³ mm ³)	r _x Inch (mm)	I _y Inch ⁴ (10 ² mm ⁴)	S _y Inch ³ (10 ³ mm ³)	r _y Inch (mm)		
12 x 12 310 x 310	W12x252	74.10	74.10	1.395	13.005	2.250	9.125	2.850	1.500	0.787	2720	353	6.06	6.06	127	3.34	428	196
	W310x375	47804	47804	35	330	57	232	72	38	20	113214	5785	154	154	2081	85	7014	3212
	W12x230	67.70	67.70	1.285	12.895	2.070	9.125	2.670	1.500	0.787	2420	321	5.97	5.97	115	3.31	386	177
	W310x342	43675	43675	33	328	53	232	68	38	20	100727	5260	152	152	1885	84	6325	2900
	W12x210	61.80	61.80	1.180	12.790	1.900	9.125	2.500	1.438	0.787	2140	292	5.89	5.89	104	3.28	348	159
	W310x313	39869	39869	30	325	48	232	64	37	20	89073	4785	150	150	1704	83	5703	2606
	W12x190	55.80	55.80	1.060	12.670	1.735	9.125	2.330	1.375	0.787	1890	263	5.82	5.82	93	3.25	311	143
	W310x283	35998	35998	27	322	44	232	59	35	20	78667	4310	148	148	1524	83	5096	2343
	W12x170	50.00	50.00	0.960	12.570	1.560	9.125	2.160	1.313	0.787	1650	235	5.74	5.74	82.3	3.22	275	126
	W310x253	32257	32257	24	319	40	232	55	33	20	68678	3851	146	146	1349	82	4506	2065
	W12x152	44.70	44.70	0.870	12.480	1.400	9.125	2.000	1.250	0.787	1430	209	5.66	5.66	72.8	3.19	243	111
	W310x226	28837	28837	22	317	36	232	51	32	20	59521	3425	144	144	1193	81	3982	1819
	W12x136	39.90	39.90	0.790	12.400	1.250	9.125	1.850	1.250	0.787	1240	186	5.58	5.58	64.2	3.16	214	98
	W310x202	25741	25741	20	315	32	232	47	32	20	51612	3048	142	142	1052	80	3507	1606
	W12x120	35.30	35.30	0.710	12.320	1.105	9.125	1.700	1.188	0.787	1070	163	5.51	5.51	56	3.13	186	85.4
	W310x179	22773	22773	18	313	28	232	43	30	20	44536	2671	140	140	918	80	3048	1399
	W12x106	31.20	31.20	0.610	12.220	0.990	9.125	1.590	1.125	0.787	933	145	5.47	5.47	49.3	3.11	164	75.1
	W310x158	20128	20128	15	310	25	232	40	29	20	38834	2376	139	139	808	79	2687	1231
	W12x96	28.20	28.20	0.550	12.160	0.900	9.125	1.500	1.125	0.787	833	131	5.44	5.44	44.4	3.09	147	67.5
	W310x143	18193	18193	14	309	23	232	38	29	20	34672	2147	138	138	728	78	2409	1106
W12x87	25.60	25.60	0.515	12.125	0.810	9.125	1.410	1.063	0.787	740	118	5.38	5.38	39.7	3.07	132	60.4	
W310x129	16515	16515	13	308	21	232	36	27	20	30801	1934	137	137	651	78	2163	990	
W12x79	23.20	23.20	0.470	12.080	0.735	9.125	1.330	1.063	0.787	662	107	5.34	5.34	35.8	3.05	119	54.3	
W310x117	14967	14967	12	307	19	232	34	27	20	27554	1753	136	136	587	77	1950	890	
W12x72	21.10	21.10	0.430	12.040	0.670	9.125	1.270	1.063	0.787	597	97.4	5.31	5.31	32.4	3.04	108	49.2	
W310x107	13612	13612	11	306	17	232	32	27	20	24849	1596	135	135	531	77	1770	806	
W12x65	19.10	19.10	0.390	12.000	0.605	9.125	1.200	1.000	0.787	533	87.9	5.28	5.28	29.1	3.02	96.8	44.1	
W310x97	12322	12322	10	305	15	232	30	25	20	22185	1440	134	134	477	77	1586	723	
12 x 10 310 x 250	W12x58	17.00	17.00	0.360	10.010	0.640	9.250	1.240	0.938	0.787	475	78	5.28	5.28	21.4	2.51	86.4	32.5
	W310x86	10967	10967	9	254	16	235	31	24	20	19771	1278	134	134	351	64	1416	533
	W12x53	15.60	15.60	0.345	9.995	0.575	9.250	1.180	0.938	0.787	425	70.6	5.23	5.23	19.2	2.48	77.9	29.1
W310x79	10064	10064	9	254	15	235	30	24	20	17690	1157	133	133	315	63	1277	477	
12 x 8 310 x 200	W12x50	14.70	14.70	0.370	8.808	0.640	9.250	1.140	0.938	0.787	391	64.2	5.18	5.18	13.9	1.96	71.9	21.3
	W310x74	9483	9483	9	224	16	235	29	24	20	16275	1052	132	132	228	50	1178	349
	W12x45	13.20	13.20	0.335	8.045	0.575	9.250	1.080	0.938	0.787	348	57.7	5.15	5.15	12.4	1.95	64.2	19
	W310x67	8516	8516	9	204	15	235	27	24	20	14485	946	131	131	203	50	1052	311
W12x40	11.80	11.80	0.295	8.005	0.515	9.250	1.020	0.875	0.787	307	51.5	5.13	5.13	11	1.94	57	16.8	
W310x60	7613	7613	7	203	13	235	26	22	20	12778	844	130	130	180	49	934	275	
12 x 6.5 310 x 170	W12x35	10.30	10.30	0.300	6.560	0.520	10.125	0.820	0.750	0.400	285	45.6	5.25	5.25	7.47	1.54	51.2	11.5
	W310x52	6645	6645	8	167	13	257	21	19	10	11862	747	133	133	122	39	839	188
	W12x30	8.79	8.79	0.260	6.520	0.440	10.125	0.740	0.750	0.400	238	38.6	5.21	5.21	6.24	1.52	43.1	9.56
	W310x44.5	5671	5671	7	166	11	257	19	19	10	9906	633	132	132	102	39	706	157
W12x26	7.65	7.65	0.230	6.490	0.380	10.125	0.680	0.750	0.400	204	33.4	5.17	5.17	5.34	1.51	37.2	8.17	
W310x38.7	4935	4935	6	165	10	257	17	19	10	8491	547	131	131	88	38	610	134	
12 x 4 310 x 130	W12x22	6.48	6.48	0.260	4.030	0.425	10.375	0.725	0.625	0.400	156	25.4	4.91	4.91	2.31	0.848	29.3	3.66
	W310x32.7	4180	4180	7	102	11	264	18	16	10	6493	416	125	125	38	22	480	60
	W12x19	5.57	5.57	0.235	4.005	0.350	10.375	0.650	0.563	0.400	130	21.3	4.82	4.82	1.88	0.822	24.7	2.98
	W310x28.3	3593	3593	6	102	9	264	17	14	10	5411	349	122	122	31	21	405	49
	W12x16	4.71	4.71	0.220	3.990	0.265	10.375	0.565	0.563	0.400	103	17.1	4.67	4.67	1.41	0.773	20.1	2.26
	W310x23.8	3039	3039	6	101	7	264	14	14	10	4287	280	119	119	23	20	329	37
W12x14	4.16	4.16	0.200	3.970	0.225	10.375	0.525	0.563	0.400	88.6	14.9	4.62	4.62	1.19	0.753	17.4	1.9	
W310x21.0	2684	2684	5	101	6	264	13	14	10	3688	244	117	117	20	19	285	31	

WIDE FLANGE BEAMS

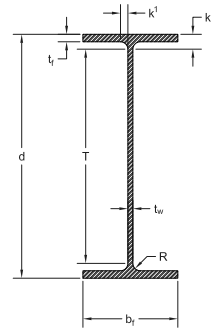

W10 & W250

Prime Section Group	Section Size Inch x lbs/ft (mm x kg/m)	Area A Inch ² (mm ²)	Depth d Inch (mm)	Web Thickness t _w Inch (mm)	Flange		Distance			Fillet Radius R Inch (mm)	Elastic Properties						Plastic Modulus	
					Width b _f Inch (mm)	Thickness t _f Inch (mm)	T Inch (mm)	k Inch (mm)	k' Inch (mm)		X - X			Y - Y			Z _x Inch ³ (10 ³ mm ³)	Z _y Inch ³ (10 ³ mm ³)
											I _x Inch ⁴ (10 ⁶ mm ⁴)	S _x Inch ³ (10 ³ mm ³)	r _x Inch (mm)	I _y Inch ⁴ (10 ⁶ mm ⁴)	S _y Inch ³ (10 ³ mm ³)	r _y Inch (mm)		
10 x 10 250 x 250	W10x112	33.59	11.36	0.755	10.415	1.250	7.546	1.907	1.035	0.657	716	126	4.66	236	45.3	2.68	147	69.2
	W250x167	21670	289	19	265	32	192	48	26	17	29802	2065	118	9823	742	68	2409	1134
	W10x100	30.05	11.10	0.680	10.340	1.120	7.546	1.777	0.997	0.657	623	112	4.6	207	40	2.65	130	61
	W250x149	19386	282	17	263	28	192	45	25	17	25931	1835	117	8616	655	67	2130	1000
	W10x88	26.54	10.84	0.605	10.265	0.990	7.546	1.647	0.960	0.657	534	98.5	4.54	179	34.8	2.63	113	53.1
	W250x131	17122	275	15	261	25	192	42	24	17	22227	1614	115	7450	570	67	1852	870
	W10x77	23.29	10.60	0.530	10.190	0.870	7.546	1.527	0.922	0.657	455	85.9	4.49	154	30.1	2.6	97.6	45.9
	W250x115	15025	269	13	259	22	192	39	23	17	18938	1408	114	6410	493	66	1599	752
	W10x68	20.62	10.40	0.470	10.130	0.770	7.546	1.427	0.892	0.657	394	75.7	4.44	134	26.4	2.59	85.3	40.1
	W250x101	13303	264	12	257	20	192	36	23	17	16399	1240	113	5577	433	66	1398	657
10 x 8 250 x 200	W10x45	13.91	10.10	0.350	8.020	0.620	7.546	1.277	0.832	0.657	248	49.1	4.32	53.4	13.3	2.01	54.9	20.3
	W250x67	8974	257	9	204	16	192	32	21	17	10322	805	110	2223	218	51	900	333
	W10x39	12.11	9.92	0.315	7.985	0.530	7.546	1.187	0.815	0.657	209	42.1	4.27	45	11.3	1.98	46.8	17.2
	W250x58	7813	252	8	203	13	192	30	21	17	8699	690	108	1873	185	50	767	282
10 x 5.75 250 x 150	W10x30	9.31	10.47	0.300	5.810	0.510	8.506	0.982	0.622	0.472	170	32.4	4.38	16.7	5.75	1.37	36.6	8.84
	W250x44.8	6006	266	8	148	13	216	25	16	12	7076	531	111	695	94	35	600	145
	W10x26	8.08	10.33	0.260	5.770	0.440	8.506	0.912	0.602	0.472	144	27.9	4.35	14.1	4.89	1.36	31.3	7.5
	W250x38.5	5213	262	7	147	11	216	23	15	12	5994	457	110	587	80	35	513	123
10 x 4 250 x 100	W10x22	6.96	10.17	0.240	5.750	0.360	8.506	0.832	0.592	0.472	118	23.2	4.27	11.4	3.97	1.33	26	6.1
	W250x32.7	4490	258	6	146	9	216	21	15	12	4911	380	108	474	65	34	426	100
	W10x19	5.85	10.24	0.250	4.020	0.395	8.506	0.867	0.597	0.472	96.3	18.8	4.14	4.29	2.14	0.874	21.6	3.35
	W250x28.4	3774	260	6	102	10	216	22	15	12	4008	308	105	179	35	22	354	55
	W10x17	5.22	10.11	0.240	4.010	0.330	8.506	0.802	0.592	0.472	81.9	16.2	4.05	3.56	1.78	0.845	18.7	2.8
	W250x25.3	3368	257	6	102	8	216	20	15	12	3409	265	103	148	29	21	306	46
10 x 4 250 x 100	W10x15	4.64	9.99	0.230	4.000	0.270	8.506	0.742	0.587	0.472	68.9	13.8	3.95	2.89	1.45	0.81	16	2.3
	W250x22.3	2993	254	6	102	7	216	19	15	12	2868	226	100	120	24	21	262	38
	W10x12	3.77	9.87	0.190	3.960	0.210	8.506	0.682	0.567	0.472	53.8	10.9	3.9	2.18	1.1	0.785	12.6	1.74
W250x17.9	2432	251	5	101	5	216	17	14	12	2239	179	99	91	18	20	206	29	

WIDE FLANGE BEAMS

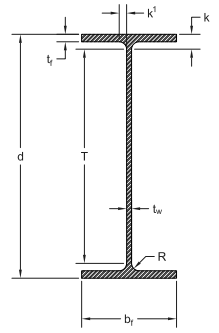

W8 & W200

Prime Section Group	Section Size Inch x lbs/ft (mm x kg/m)	Area A Inch ² (mm ²)	Depth d Inch (mm)	Web Thickness t _w Inch (mm)	Flange		Distance			Fillet Radius R Inch (mm)	Elastic Properties						Plastic Modulus	
					Width b _f Inch (mm)	Thickness t _f Inch (mm)	T Inch (mm)	k Inch (mm)	k' Inch (mm)		X - X			Y - Y			Z _x Inch ³ (10 ³ mm ³)	Z _y Inch ³ (10 ³ mm ³)
											I _x Inch ⁴ (10 ⁶ mm ⁴)	S _x Inch ³ (10 ³ mm ³)	r _x Inch (mm)	I _y Inch ⁴ (10 ⁶ mm ⁴)	S _y Inch ³ (10 ³ mm ³)	r _y Inch (mm)		
8 x 8 200 x 200	W8x67	19.7	9.00	0.570	8.280	0.935	5.75	1.33	0.9375	0.51	272	60.4	3.72	88.6	21.4	2.12	70.1	32.7
	W200x100	12709	229	14	210	24	146	34	24	13	11321	990	94	3688	351	54	1149	536
	W8x58	17.1	8.75	0.510	8.220	0.810	5.75	1.2	0.875	0.51	228	52	3.65	75.1	18.3	2.1	59.8	27.9
	W200x86	11032	222	13	209	21	146	30	22	13	9490	852	93	3126	300	53	980	457
	W8x48	14.1	8.50	0.400	8.110	0.685	5.75	1.08	0.875	0.51	184	43.2	3.61	60.9	15	2.08	49.0	22.9
	W200x71	9096	216	10	206	17	146	27	22	13	7659	708	92	2535	246	53	803	375
	W8x40	11.7	8.25	0.360	8.070	0.560	5.75	0.954	0.8125	0.51	146	35.5	3.53	49.1	12.2	2.04	39.8	18.5
	W200x59	7548	210	9	205	14	146	24	21	13	6077	582	90	2044	200	52	652	303
8 x 6.5 200 x 170	W8x35	10.3	8.12	0.310	8.020	0.495	5.75	0.889	0.8125	0.51	127	31.2	3.51	42.6	10.6	2.03	34.7	16.1
	W200x52	6645	206	8	204	13	146	23	21	13	5286	511	89	1773	174	52	569	264
	W8x31	9.13	8.00	0.285	7.995	0.435	5.75	0.829	0.75	0.51	110	27.5	3.47	37.1	9.27	2.02	30.4	14.1
	W200x46.1	5890	203	7	203	11	146	21	19	13	4579	451	88	1544	152	51	498	231
8 x 5.25 200 x 130	W8x28	8.25	8.06	0.285	6.535	0.465	6.125	0.859	0.625	0.51	98	24.3	3.45	21.7	6.63	1.62	27.2	10.1
	W200x41.7	5322	205	7	166	12	156	22	16	13	4079	398	88	903	109	41	446	166
	W8x24	7.08	7.93	0.245	6.495	0.400	6.125	0.794	0.5625	0.51	82.7	20.9	3.42	18.3	5.63	1.61	23.1	8.57
8 x 4 200 x 100	W200x35.9	4568	201	6	165	10	156	20	14	13	3442	342	87	762	92	41	379	140.4
	W8x21	6.16	8.28	0.250	5.270	0.400	6.5	0.7	0.5625	0.39	75.3	18.2	3.49	9.77	3.71	1.26	20.4	5.69
	W200x31.3	3974	210	6	134	10	165	18	14	10	3134	298	89	407	61	32	334	93
8 x 4 200 x 100	W8x18	5.26	8.14	0.23	5.250	0.330	6.5	0.63	0.5625	0.39	61.9	15.2	3.43	7.97	3.04	1.23	17.0	4.66
	W200x26.6	3393	207	6	133	8	165	16	14	10	2576	249	87	332	50	31	279	76
	W8x15	4.44	8.11	0.245	4.015	0.315	6.5	0.615	0.5625	0.51	48	11.8	3.29	3.41	1.7	0.876	13.6	2.67
	W200x22.5	2864	206	6	102	8	165	16	14	13	1998	193	84	142	28	22	223	44
8 x 4 200 x 100	W8x13	3.84	7.99	0.230	4.000	0.255	6.5	0.555	0.5625		39.6	9.91	3.21	2.73	1.37	0.843	11.4	2.15
	W200x19.3	2477	203	6	102	6	165	14	14	0	1648	162	82	114	22	21	187	35
	W8x10	2.96	7.89	0.170	3.940	0.205	6.5	0.505	0.5		30.8	7.81	3.22	2.09	1.06	0.841	8.87	1.66
	W200x15	1910	200	4	100	5	165	13	13	0	1282	128	82	87	17	21	145	27

W6 & W150

Prime Section Group	Section Size Inch x lbs/ft (mm x kg/m)	Area A Inch ² (mm ²)	Depth d Inch (mm)	Web Thickness t _w Inch (mm)	Flange		Distance			Fillet Radius R Inch (mm)	Elastic Properties						Plastic Modulus	
					Width b _f Inch (mm)	Thickness t _f Inch (mm)	T Inch (mm)	k Inch (mm)	k' Inch (mm)		X - X			Y - Y			Z _x Inch ³ (10 ³ mm ³)	Z _y Inch ³ (10 ³ mm ³)
											I _x Inch ⁴ (10 ⁶ mm ⁴)	S _x Inch ³ (10 ³ mm ³)	r _x Inch (mm)	I _y Inch ⁴ (10 ⁶ mm ⁴)	S _y Inch ³ (10 ³ mm ³)	r _y Inch (mm)		
6 x 6 150 x 150	W6x25	7.34	6.38	0.32	6.08	0.455	4.526	0.828	0.47	0.472	53.6	16.8	2.7	17.1	5.61	1.52	19	8.57
	W150x37.1	4735	162	8	154	12	115	21	12	12	2231	275	69	712	92	39	311	140
	W6x20	5.87	6.2	0.26	6.02	0.365	4.526	0.738	0.44	0.472	41.5	13.4	2.66	13.3	4.41	1.5	15	6.72
	W150x29.8	3787	157	7	153	9	115	19	11	12	1727	220	68	554	72	38	246	110
	W6x15	4.43	5.99	0.23	5.99	0.26	4.53	0.63	0.43	0.47	29.30	9.77	2.56	9.32	3.11	1.45	10.80	4.75
6 x 4 150 x 100	W150x22.5	2858	152	6	152	7	115	16	11	12	1220	160	65	388	51	37	177	78
	W6x16	4.74	4.03	0.26	4.03	0.405	4.526	0.655	0.5625	0.472	32.1	10.2	2.6	4.43	2.2	0.96	11.7	3.39
	W150x24	3058	102	7	102	10	114960	17	14	12	1336	167	66	184	36	24	192	56
	W6x12	3.55	4	0.23	4	0.28	4.526	0.53	0.5625	0.472	22.1	7.31	2.49	2.99	1.5	0.918	8.3	2.32
	W150x18	2290	102	6	102	7	115	13	14	12	920	120	63	124	25	23	136	38
	W6x9	2.68	3.94	0.17	3.94	0.215	4.526	0.465	0.5	0.472	16.4	5.56	2.47	2.2	1.11	0.905	6.23	1.72
	W150x13.5	1729	100	4	100	5	115	12	13	12	683	91	63	92	18	23	102	28
6 x 4 150 x 100	W6x8.5	2.52	3.94	0.17	3.94	0.19	4.50	0.45	0.50	0.47	14.90	5.10	2.43	1.99	1.01	0.89	5.73	1.56
	W150x13.5	1626	100	4	100	5	114	11	13	12	620	84	62	83	17	23	94	26

WIDE FLANGE BEAMS

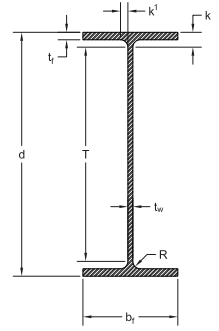

W5 & W130

Prime Section Group	Section Size Inch x lbs/ft (mm x kg/m)	Area A Inch ² (mm ²)	Depth d Inch (mm)	Web Thickness t _w Inch (mm)	Flange		Distance			Fillet Radius R Inch (mm)	Elastic Properties						Plastic Modulus	
					Width b _f Inch (mm)	Thickness t _f Inch (mm)	T Inch (mm)	k Inch (mm)	k' Inch (mm)		X - X			Y - Y			Z _x Inch ³ (10 ³ mm ³)	Z _y Inch ³ (10 ³ mm ³)
											I _x Inch ⁴ (10 ⁶ mm ⁴)	S _x Inch ³ (10 ³ mm ³)	r _x Inch (mm)	I _y Inch ⁴ (10 ⁶ mm ⁴)	S _y Inch ³ (10 ³ mm ³)	r _y Inch (mm)		
5 x 5 130 x 130	W5x19	5.56	5.15	0.27	5.03	0.43	3.5	0.835	0.540	0.405	26.3	10.2	2.17	9.13	3.63	1.28	11.6	5.53
	W130x28.1	3587	131	7	128	11	89	21	14	10	1095	167	55	380	59	33	190	91
	W5x16	4.71	5.05	0.24	5	0.36	3.5	0.765	0.525	0.405	21.4	8.55	2.13	7.51	3.00	1.26	9.63	4.58
	W130x23.8	3039	128	6	127	9	89	19	13	10	891	140	54	313	49	32	158	75
	W6x15	14.1	8.50	0.400	8.110	0.685	5.75	1.08	0.875	0.51	184	43.2	3.61	60.9	15	2.08	49.0	22.9
W150x22.5	9096	216	10	206	17	146	27	22	13	7659	708	92	2535	246	53	803	375	

W4 & W100

Prime Section Group	Section Size Inch x lbs/ft (mm x kg/m)	Area A Inch ² (mm ²)	Depth d Inch (mm)	Web Thickness t _w Inch (mm)	Flange		Distance			Fillet Radius R Inch (mm)	Elastic Properties						Plastic Modulus	
					Width b _f Inch (mm)	Thickness t _f Inch (mm)	T Inch (mm)	k Inch (mm)	k' Inch (mm)		X - X			Y - Y			Z _x Inch ³ (10 ³ mm ³)	Z _y Inch ³ (10 ³ mm ³)
											I _x Inch ⁴ (10 ⁶ mm ⁴)	S _x Inch ³ (10 ³ mm ³)	r _x Inch (mm)	I _y Inch ⁴ (10 ⁶ mm ⁴)	S _y Inch ³ (10 ³ mm ³)	r _y Inch (mm)		
4 x4 100 x 100	W4 x 13	3.83	4.16	0.28	4.060	0.345	2.660	0.750	0.545	0.405	11.300	5.460	1.720	3.860	1.900	1.000	6.280	2.920
	W100x19.3	2471	106	7	103	9	68	19	14	10	470	89	44	161	31	25	23	48

WIDE FLANGE ASTM TABLE

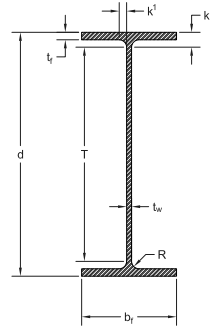

STRUCTURAL SECTIONS

BEAM Available Steel Grades								
American			Canadian			European *		
ASTM	Yield Strength		CSA G40.21	Yield Strength		EN 10025 & EN 10113	Yield Strength	
	ksi	MPa		ksi	MPa		ksi	MPa
A 36	36	250	Grade 350 W	50	350	S 235	34	235
A 572 Grade 50	50	345				S 275	40	275
A 588	50	345				S 355	51	355
A 709	50	345				S 460 HISTAR	67	460
A 913	50	345						
A 913	65	450						
A 992	50	345						

* HISTAR only available in some sizes

DELIVERY CONDITIONS & TOLERANCES

ASTM A 6

Mass	± 2.5%		
Depth	± 0.125 inches		
Length	30 feet and Under	Over 30 Feet	
	Beams W 24 and Under	± 0.375 inches	+ (0.375 inches + (Length - 30) / 80
Beams Over W 24	± 0.5 inches	+ (0.5 inches + (Length - 30) / 80	-0.375 inches
Flanges out of Square			
Beams W 12 and Under	≤ 0.25 inches		
Beams Over W 12	≤ 0.3125 inches		
Web off Center	≤ 0.1875 inches		
Greatest Depth over Theoretical	≤ 0.25 inches		
Camber and Sweep	(0.125 in) * (Length / 10)		
Camber and Sweep for Columns			
45 Feet and Under	(0.125 in) * (Length / 10) but not over 0.375 inches		
Over 45 Feet	(0.375 in) + (0.125 in * (Length - 45) / 10		

*W 8 x 31 and heavier, W 10 x 49 and heavier, W 12 x 65 and heavier, and W 14 x 90 and heavier order as columns. If other sections are ordered as columns, the tolerances are subject to negotiation with manufacturer.

CHANNEL

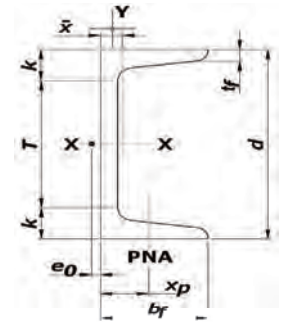

MC

Prime Section Group	Section Size Inch x lbs/ft (mm x kg/m)	Area A Inch ² (mm ²)	Depth d Inch (mm)	Web Thickness t _w Inch (mm)	Flange		Distance			Fillet Radius R Inch (mm)	Elastic Properties						Plastic Modulus	
					Width b _f Inch (mm)	Thickness t _f Inch (mm)	T Inch (mm)	k Inch (mm)	k ⁱ Inch (mm)		X - X			Y - Y			Z _x Inch ³ (10 ³ mm ³)	Z _y Inch ³ (10 ³ mm ³)
											I _x Inch ⁴ (10 ⁶ mm ⁴)	S _x Inch ³ (10 ³ mm ³)	r _x Inch (mm)	I _y Inch ⁴ (10 ⁶ mm ⁴)	S _y Inch ³ (10 ³ mm ³)	r _y Inch (mm)		
18 x 4 460 x 100	MC18 x 58.0 MC460 x 86	17.1 11 000	18.00 457	0.700 17.8	4.200 107	0.625 15.9	15.375 390	1.313 33	0.975 25	0.625 16	675 281	75.0 1 229	6.29 159.8	17.6 7.3	5.28 87	1.020 25.9	95.4 1 563	10.70 175
	MC18 x 51.9 MC460 x 77.2	15.3 9 870	18.00 457	0.600 15.2	4.100 104	0.625 15.9	15.375 390	1.313 33	0.925 24	0.625 16	627 261	69.6 1 141	6.41 162.8	16.3 6.8	5.02 82	1.030 26.2	87.3 1 431	9.86 162
	MC18 x 45.8 MC460 x 68.2	13.5 8 710	18.00 457	0.500 12.7	4.000 102	0.625 15.9	15.375 390	1.313 33	0.875 22	0.625 16	578 241	64.2 1 052	6.55 166.4	14.9 6.2	4.77 78	1.050 26.7	79.2 1 298	9.14 150
	MC18 x 42.7 MC460 x 63.5	12.60 8 130	18.00 457	0.450 11.4	3.950 100	0.625 15.9	15.375 390	1.313 33	0.850 22	0.625 16	554 231	61.5 1 008	6.64 168.7	14.3 6.0	4.64 76	1.070 27.2	75.1 1 231	8.82 145
13 x 4 330 x 100	MC13 x 50.0 MC330 x 74	14.70 9 480	13.00 330	0.787 20.0	4.412 112	0.610 15.5	10.655 270	1.173 30	0.894 23	0.500 13	314 131	48.3 791	4.62 117.3	16.4 6.8	4.77 78	1.060 26.9	60.8 996	10.20 167
	MC13 x 40.0 MC330 x 60	11.80 7 610	13.00 330	0.560 14.2	4.185 106	0.610 15.5	10.655 270	1.173 30	0.780 20	0.500 13	273 114	41.9 687	4.82 122.4	13.7 5.7	4.24 69	1.080 27.4	51.2 839	8.66 142
	MC13 x 35.0 MC330 x 52	10.30 6 640	13.00 330	0.447 11.4	4.072 103	0.610 15.5	10.655 270	1.173 30	0.724 19	0.500 13	252 105	38.8 636	4.95 125.7	12.3 5.1	3.97 65	1.090 27.7	46.5 762	8.04 132
	MC13 x 31.8 MC330 x 47.3	9.35 6 030	13.00 330	0.375 9.5	4.000 102	0.610 15.5	10.655 270	1.173 30	0.688 18	0.500 13	239 99	36.7 601	5.05 128.3	11.4 4.7	3.79 62	1.100 27.9	43.4 711	7.69 126
12 x 4 310 x 100	MC12 x 50.0 MC310 x 74	14.70 9 480	12.00 305	0.835 21.2	4.135 105	0.700 17.8	9.475 240	1.263 32	0.918 24	0.500 13	269 112	44.9 736	4.28 108.7	17.4 7.2	5.64 92	1.090 27.7	56.5 926	10.90 179
	MC12 x 45.0 MC310 x 67	13.20 8 502	12.00 305	0.710 18.0	4.010 102	0.700 17.8	9.475 240	1.263 32	0.855 22	0.500 13	251 104	41.9 687	4.36 110.7	15.8 6.6	5.30 87	1.090 27.7	52.0 852	10.10 166
	MC12 x 40.0 MC310 x 60	11.80 7 610	12.00 305	0.590 15.0	3.890 98	0.700 17.8	9.475 240	1.263 32	0.795 21	0.500 13	234 97	39.0 639	4.46 113.3	14.2 5.9	4.98 82	1.100 27.9	47.7 782	9.31 153
	MC12 x 35.0 MC310 x 52	10.30 6 620	12.00 305	0.465 11.8	3.765 96	0.700 17.8	9.475 240	1.263 32	0.733 19	0.500 13	216 90	36.0 590	4.59 116.6	12.6 5.2	4.64 76	1.110 28.2	43.2 708	8.62 141
	MC12 x 31.0 MC310 x 46	9.12 5 890	12.00 305	0.370 9.4	3.670 93	0.700 17.8	9.475 240	1.263 32	0.685 18	0.500 13	202 84	33.7 552	4.71 119.6	11.3 4.7	4.37 72	1.110 28.2	39.7 651	8.15 134

CHANNEL

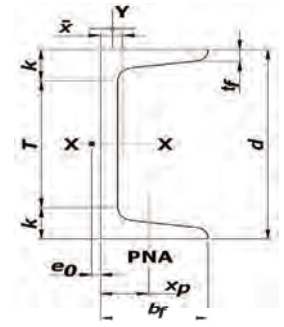

C

Prime Section Group	Section Size Inch x lbs/ft (mm x kg/m)	Area A Inch ² (mm ²)	Depth d Inch (mm)	Web Thickness t _w Inch (mm)	Flange		Distance			Fillet Radius R Inch (mm)	Elastic Properties						Plastic Modulus	
					Width b _f Inch (mm)	Thickness t _f Inch (mm)	T Inch (mm)	k Inch (mm)	k ^l Inch (mm)		X - X			Y - Y				
											I _x Inch ⁴ (10 ⁶ mm ⁴)	S _x Inch ³ (10 ³ mm ³)	r _x Inch (mm)	I _y Inch ⁴ (10 ⁶ mm ⁴)	S _y Inch ³ (10 ³ mm ³)	r _y Inch (mm)	Z _x Inch ³ (10 ³ mm ³)	Z _y Inch ³ (10 ³ mm ³)
					15 x 3.375 380 x 85	C15 x 50.0 C380 x 74	14.7 9 480	15.00 381	0.716 18.2		3.716 94	0.650 16.5	12.575 319	1.213 31	0.858 22	0.50 13	404 168	53.8 882
C15 x 40.0 C380 x 60	11.8 7 610	15.00 381	0.520 13.2	3.520 89		0.650 16.5	12.575 319	1.213 31	0.760 20	0.50 13	348 144.8	46.5 762	5.45 138.4	9.2 3.8	3.34 55	0.883 22.4	57.5 942	6.84 112
C15 x 33.9 C380 x 50.4	9.96 6 430	15.00 381	0.400 10.2	3.400 86		0.650 16.5	12.575 319	1.213 31	0.700 18	0.50 13	315 131.1	42.0 688	5.62 142.7	8.1 3.4	3.09 51	0.901 22.9	50.8 832	6.19 101
12 x 3 310 x 75	C12 x 30.0 C310 x 45	8.82 5 690	12.00 305	0.510 13.0	3.170 80	0.501 12.7	10.123 257	0.939 24	0.630 17	0.375 10	162 67.4	27.0 442	4.29 109.0	5.1 2.1	2.05 34	0.762 19.4	33.8 554	4.32 71
	C12 x 25.0 C310 x 37	7.35 4 740	12.00 305	0.387 9.8	3.047 77	0.501 12.7	10.123 257	0.939 24	0.569 15	0.375 10	144 59.9	24.0 393	4.43 112.5	4.5 1.9	1.87 31	0.779 19.8	29.4 482	3.82 63
	C12 x 20.7 C310 x 30.8	6.09 3 930	12.00 305	0.282 7.2	2.942 74	0.501 12.7	10.123 257	0.939 24	0.516 14	0.375 10	129 53.7	21.5 352	4.61 117.1	3.9 1.6	1.72 28	0.797 20.2	25.6 420	3.47 57



STRUCTURAL SECTIONS

BEAM Available Steel Grades								
American			Canadian			European *		
ASTM	Yield Strength		CSA G40.21	Yield Strength		EN 10248	Yield Strength	
	ksi	MPa		ksi	MPa		ksi	MPa
A 36	36	250	Grade 350 W	50	350	S 235 GP	34	235
A 572 Grade 50	50	345				S 355 GP	51	355
A 572 Grade 60	60	415						
A 588	50	345						
A 242	50	345						

DELIVERY CONDITIONS & TOLERANCES

ASTM A 6

Mass	± 2.5%					
Depth	3 to 7 in		7 to 14 in		Over 14 in	
	+ 0.9375 in	- 0.0625 in	+ 0.125 in	- 0.9375 in	+ 0.1875 in	- 0.125
Length	5 to 10 ft	10 to 20 ft	20 to 30 ft	30 to 40 ft	40 to 50 ft	50 to 65 ft
	+ 1.0 in +	1.5 in	+ 1.75 in	+ 2.25 in	+ 2.75 in	+ 2.75 in
Flange Width	3 to 7 in		7 to 14 in		Over 14 in	
	± 0.125 in		+ 0.125 in	- 0.9375 in	+ 0.125 in	- 0.1875
Flanges out of Square	≤ 0.03125 in					
Camber	(0.125 in) * (Length / 5)					
Sweep	Subject to negotiation with manufacturer					

CONVERSION CHART

CONVERSION CHART

	IMPERIAL TO METRIC				METRIC TO IMPERIAL		
Dimensions, Area, Volume	1 in	=	2.5400 cm	Dimensions, Area, Volume	1 cm	=	0.3937 in
	1 ft	=	0.3048 m		1 m	=	3.2808 ft
	1 in ²	=	6.4516 cm ²		1 cm ²	=	0.1550 in ²
	1 ft ²	=	0.0929 m ²		1 m ²	=	10.7639 ft ²
	1 in ³	=	16.3870 cm ³		1 cm ³	=	0.0610 in ³
	1 ft ³	=	0.0283 m ³		1 m ³	=	35.3149 ft ³
	1 in ² /ft	=	21.166 cm ² /m		1 cm ² /m	=	0.0472 in ² /ft
Mass, Force, Pressure	1 lb	=	4.4497 N	Mass, Force, Pressure	1 N	=	0.2247 lb
	1 lb/in	=	0.1752 N/mm		1 N/mm	=	5.7082 lb/in
	1 lb/ft	=	14.5989 N/m		1 N/m	=	0.0685 lb/ft
	1 lb/in ²	=	0.6897 N/cm ²		1 N/cm ²	=	1.4499 lb/in ²
	1 lb/ft ²	=	47.8968 N/m ²		1 N/m ²	=	0.0209 lb/ft ²
	1 lb/in ³	=	0.2715 N/cm ³		1 N/cm ³	=	3.6827 lb/in ³
	1 lb/ft ³	=	157.1420 N/m ³		1 N/m ³	=	0.0064 lb/ft ³
	1 lb	=	0.4536 kg		1 kg	=	2.2046 lbs
	1 lb/ft	=	1.4882 kg/m		1 kg/m	=	0.6720 lb/ft
	1 lb/ft ²	=	4.8824 kg/m ²		1 kg/m ²	=	0.2048 lb/ft ²
	1 US Ton	=	0.9072 Metric Tons		1 Metric Ton	=	1.1023 US Tons
Moment of Inertia	1 in ⁴	=	41.6228 cm ⁴	Moment of Inertia	1 cm ⁴	=	0.0240 in ⁴
	1 in ⁴ /ft	=	136.5582 cm ⁴ /m		1 cm ⁴ /m	=	0.0073 in ⁴ /ft
Section Modulus	1 in ³	=	16.3870 cm ³	Section Modulus	1 cm ³	=	0.0610 in ³
	1 in ³ /ft	=	53.7631 cm ³ /m		1 cm ³ /m	=	0.0186 in ³ /ft
Bending Moment	1 lb.ft	=	1.3563 Nm	Bending Moment	1 Nm	=	0.7373 lb.ft
	1 lb.in/ft	=	0.3708 Nm/m		1 Nm/m	=	2.6968 lb.in/ft
	1 lb.ft/ft	=	4.4497 Nm/m		1 Nm/m	=	0.2247 lb.ft/ft

NOTES

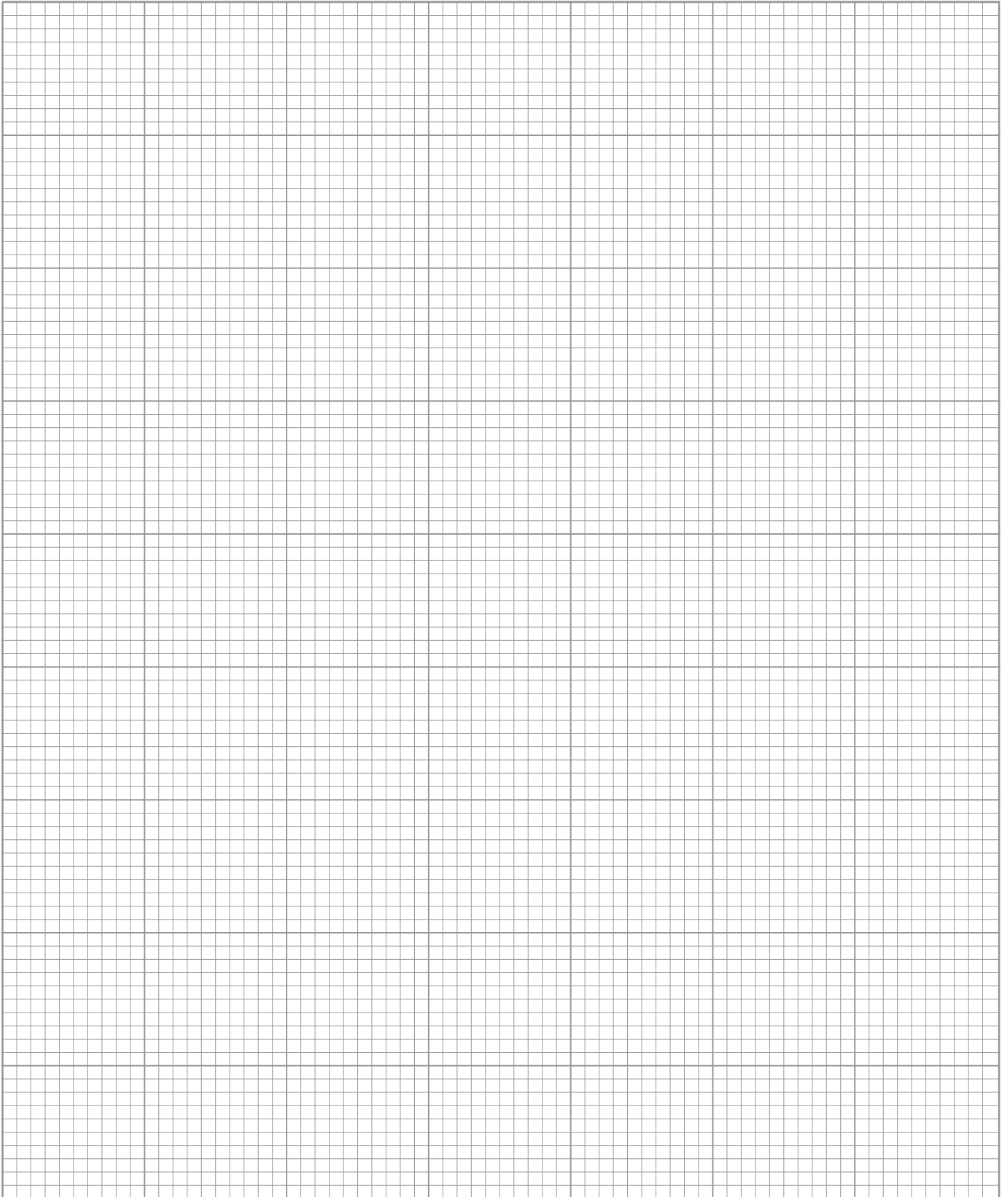

JD
FIELDS
& COMPANY, INC.
A FIELDS COMPANY